

UNITED STATES DISTRICT COURT  
MIDDLE DISTRICT OF FLORIDA  
JACKSONVILLE DIVISION

CASE No: 3:21-cr22(S2)-MMH-MCR

UNITED STATES OF AMERICA,

v.

MATTHEW RAYMOND HOOVER,

---

**REQUEST FOR JUDICIAL NOTICE IN SUPPORT OF  
DEFENDANT’S MOTION TO DISMISS**

Pursuant to Federal Rule of Evidence 201, Defendant Matthew Raymond Hoover (“Defendant”) respectfully moves this Court to take judicial notice of the Bureau of Alcohol, Tobacco, Firearms and Explosives’ letter of December 17, 2018 (“Exhibit-A”) and administrative rulemaking covering the definition of “firearm” (“Exhibit-B”) in support of his Motion to Dismiss. In support of this Motion, Defendant states:

**I. LEGAL STANDARDS AND ARGUMENT**

Pursuant to Federal Rule of Evidence 201(b), the Court “may judicially notice a fact that is not subject to reasonable dispute because it: (1) is generally known within the trial court’s territorial jurisdiction; or (2) can be accurately and readily determined from sources whose accuracy cannot be reasonably questioned.”

It should further be noted that the Eleventh Circuit Court of Appeals – in addressing judicial notice – has stated that:

A district court may take judicial notice of certain facts without converting a motion to dismiss into a motion for summary judgment. *See Bryant v. Avado Brands, Inc.*, 187 F.3d 1271, 1278 (11<sup>th</sup> Cir. 1999). Public records are among the permissible facts that a district court may consider. *See Stahl v. U.S. Dep’t of Agric.*, 327 F.3d 697, 700 (8<sup>th</sup> Cir. 2003) (“The district court may take judicial notice of public records and may thus consider them on a motion to dismiss.”)

*Universal Express, Inc. v. United States Securities and Exchange Commission*, 177 Fed. Appx. 52, 53 (11<sup>th</sup> Cir. 2006). *See also Parker v. Hurley*, 514 F.3d 87, 90 (1<sup>st</sup> Cir. 2008) (in disposing of a motion to dismiss, the Court considered - in addition to the complaint - three books plaintiffs found objectionable and statewide curricular standards).

<u>Exhibit</u>	<u>Description</u>
A	<p>A letter from the Bureau of Alcohol, Tobacco, Firearms and Explosives which contains the following facts to be judicially noticed:</p> <p style="padding-left: 40px;">The [drop in auto sear] generally does not require machining of the receiver for installation; with minor adjustments to the mounting body it simply fits into the rear internal area of the receiver, where the . . . machinegun automatic sear would be installed. The sear mounting body and sear together serve no other functional purpose and together are a combination of parts designed and intended solely and exclusively, to convert a semiautomatic AR-15 type firearm into a machinegun.</p>

	[. . .]  [A] fixture designed to repair and/or manufacture the parts of a DIAS . . . is not regulated under the [Gun Control Act] or the [National Firearms Act].
B	Administrative rulemaking covering the definition of “firearm.” In it, the ATF's re-defined the term “firearm”, which rescinded all previous guidance on similar devices, and provided no insight as to the device at hand.

Exhibits-A and B are public records generated by the Bureau of Alcohol, Tobacco, Firearms and Explosives and federal government. Accordingly, the Court should judicially notice the complete copies of Exhibits-A and B, which are attached hereto, so that the Court can properly consider Exhibit-A and Exhibit-B in their entirety during the course of the litigation.

**WHEREFORE** Defendant Matthew Hoover respectfully moves this Honorable Court to take judicial notice of Exhibit-A and Exhibit-B for all purposes throughout the course of the litigation of the above styled cause.

DATED: June 21, 2022

  
Zachary Z. Zermay, Esq.  
 1762 Windward Way  
 Sanibel, FL 33957  
 Email: zach@zermaylaw.com  
 Telephone: 239-699-3107  
*Lead Counsel for Defendant*

/s/Matthew Larosiere  
 Matthew Larosiere  
 6964 Houlton Circle  
 Lake Worth, FL 33467  
 Email: larosieremm@gmail.com  
 Telephone: 561-452-7575  
*Counsel for Defendant*

## CERTIFICATE OF SERVICE

**I HEREBY CERTIFY** that on June 21, 2022 I electronically filed the foregoing document with the Clerk of the Court using CM/ECF. I also certify that the foregoing document is being served this day on all counsel of record via transmission of Notices of Electronic Filing generated by CM/ECF.

  
Zachary Z. Zermay, Esq.

EXHIBIT-A



U.S. Department of Justice

Bureau of Alcohol, Tobacco,  
Firearms and Explosives

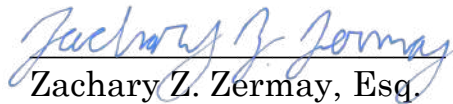
*Firearms Technology Industry Services Branch*

Hamadong, NY

www.atf.gov

DEC 17 2018

907010-GSS  
1311/309334



This refers to your correspondence to the Bureau of Alcohol, Tobacco, Firearms and Explosives (ATF), Firearms Technology Industry Services Branch (FTISB), which accompanied your submitted sample of one repair fixture. Specifically, you request an evaluation and classification of the submitted sample under the Gun Control Act of 1968 (GCA) and National Firearms Act of 1934.

As you may know, the GCA, 18 U.S.C. § 921(a)(3), defines "firearm" to include "...*(A) any weapon (including a starter gun) which will or is designed to or may readily be converted to expel a projectile by the action of an explosive; (B) the frame or receiver of any such weapon; (C) any firearm muffler or silencer; or (D) any destructive device...*"

The NFA, 26 U.S.C. § 5845(a), defines the term "firearm" as:

*"...(1) a shotgun having a barrel or barrels of less than 18 inches in length; (2) a weapon made from a shotgun if such weapon as modified has an overall length of less than 26 inches or a barrel or barrels of less than 18 inches in length; (3) a rifle having a barrel or barrels of less than 16 inches in length (4) a weapon made from a rifle if such weapon as modified has an overall length of less than 26 inches or a barrel or barrels of less than 16 inches in length; (5) any other weapon, as defined, as defined in subsection (e); (6) a machinegun; (7) any silencer (as defined in 18 U.S.C. § 921); and (8) a destructive device. The term "firearm" shall not include an antique firearm or any device (other than a machinegun or destructive device) which, although designed as a weapon, the...[Attorney General]... finds by reason of the date of its manufacture, value, design and other characteristics is primarily a collector's item and is not likely to be used as a weapon."*

The sample you have submitted is a milling fixture. In your correspondence you refer to the sample as a "DIAS Repair Jig". A *drop in auto sear* (DIAS) is designed to replicate the function

of an M16 machinegun automatic sear. The DIAS generally does not require machining of the receiver for installation; with minor adjustment to the mounting body it simply fits into the rear, internal area of the receiver, where the M16 machinegun automatic sear would be installed. The sear mounting body and sear together serve no other functional purpose and together are a combination of parts designed and intended solely and exclusively, to convert a semiautomatic AR-15 type firearm into a machinegun. Therefore, the sear mounting body and sear together are a machinegun as defined.

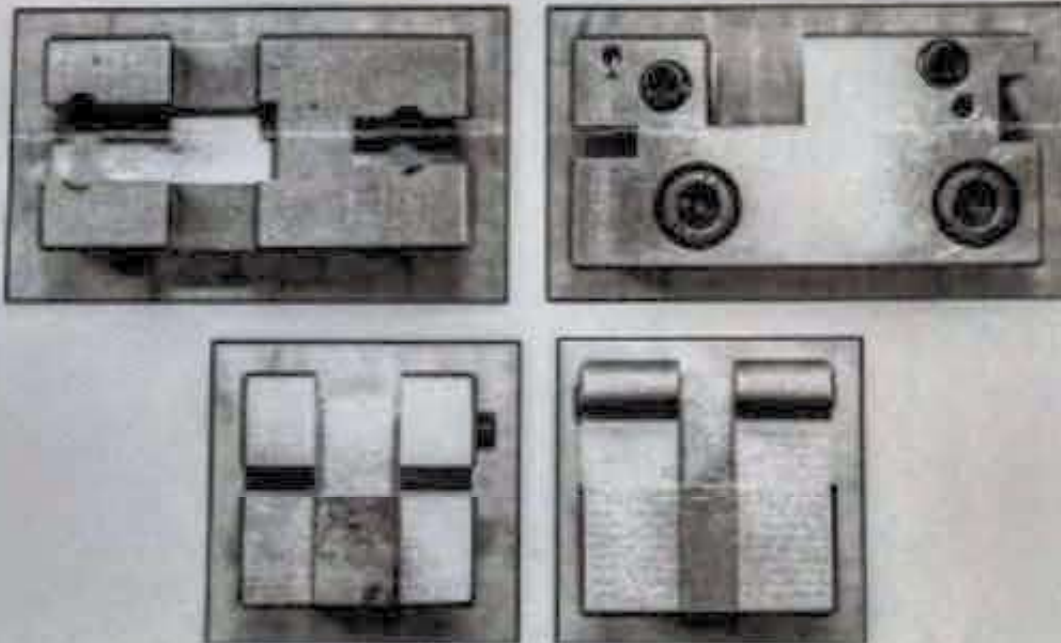

Submitted Sample

The submitted sample is a machining fixture which can be utilized to repair or manufacture a DIAS. While your stated intent demonstrates that you have designed the submitted sample solely for use in repairing a registered DIAS, there is no substantive difference between a repair fixture and a manufacturing fixture.

As stated above, a DIAS consists of two main parts identified as the sear and the sear mounting body. The submitted sample is designed to manufacture or repair each of these parts of a DIAS.

Please be aware that a part becomes a part ostensibly when it can be recognized as that part. A part need not be capable of functioning nor of being completely finished in order to be recognized. ATF has long held that indexing the location of a hole or feature is equivalent to completing the actual hole or critical feature. ATF has recognized that possessing a sear and sear mounting body, where each has been manufactured to a point where they are identifiable as the intended part, constitutes possession of a DIAS, a machinegun as defined.

Regardless of the date of manufacture of a DIAS, the possession or transfer of an unregistered DIAS (a machinegun as defined) is prohibited by the NFA 26 U.S.C. § 5861, and the GCA, 18 U.S.C. § 922(o).

The submitted sample is a fixture designed to repair and/or manufacture the parts of a DIAS. Being only a fixture for use in manufacturing or repairing a *machinegun*, the submitted sample is not regulated under the GCA or the NFA.

To facilitate the return of the submitted sample, please provide FTISB with a pre-paid shipping label or an appropriate FedEx account number within 60 days of the receipt of this letter.

We thank you for your inquiry and trust the foregoing has been responsive.

Sincerely yours,



Michael R. Curtis

Chief, Firearm Technology Industry Services Branch



**EXHIBIT-B**

**DEPARTMENT OF JUSTICE**

**Bureau of Alcohol, Tobacco, Firearms, and Explosives**

**27 CFR Parts 447, 478, and 479**

[Docket No. 2021R-05F; AG Order No. 5374-2022]

RIN 1140-AA54

**Definition of “Frame or Receiver” and Identification of Firearms**

**AGENCY:** Bureau of Alcohol, Tobacco, Firearms, and Explosives; Department of Justice.

**ACTION:** Final rule.

**SUMMARY:** The Department of Justice (“Department”) is amending Bureau of Alcohol, Tobacco, Firearms, and Explosives (“ATF”) regulations to remove and replace the regulatory definitions of “firearm frame or receiver” and “frame or receiver” because the current regulations fail to capture the full meaning of those terms. The Department is also amending ATF’s definitions of “firearm” and “gunsmith” to clarify the meaning of those terms, and to provide definitions of terms such as “complete weapon,” “complete muffler or silencer device,” “multi-piece frame or receiver,” “privately made firearm,” and “readily” for purposes of clarity given advancements in firearms technology. Further, the Department is amending ATF’s regulations on marking and recordkeeping that are necessary to implement these new or amended definitions.

**DATES:** This rule is effective August 24, 2022.

**FOR FURTHER INFORMATION CONTACT:** Vivian Chu, Office of Regulatory Affairs, Enforcement Programs and Services, Bureau of Alcohol, Tobacco, Firearms, and Explosives, U.S. Department of Justice, 99 New York Ave. NE, Washington, DC 20226; telephone: (202) 648-7070.

**SUPPLEMENTARY INFORMATION:**

- I. Executive Summary
  - A. Summary of the Regulatory Action
  - B. Summary of Costs and Benefits
- II. Background
  - A. ATF’s Application of the Definitions to Split Frames and Receivers
  - B. Privately Made Firearms
  - C. Advanced Notice of Proposed Rulemaking on Identification Markings Placed on Firearm Silencers and Firearm Mufflers
- III. Notice of Proposed Rulemaking
  - A. Definition of “Firearm”
  - B. Definition of “Frame or Receiver”
  - C. Definition of “Readily”

- D. Definitions of “Complete Weapon” and “Complete Muffler or Silencer Device”
- E. Definition of “Privately Made Firearm”
- F. Definition of “Importer’s or Manufacturer’s Serial Number”
- G. Definition of “Gunsmith”
- H. Marking Requirements for Firearms
- I. Recordkeeping
- J. Record Retention
- IV. Analysis of Comments and Department Responses for the Proposed Rule
  - A. Issues Raised in Support of the Rule
  - B. Issues Raised in Opposition to the Rule
- V. Final Rule
  - A. Definition of “Firearm”
  - B. Definition of “Frame or Receiver”
  - C. Definition of “Readily”
  - D. Definitions of “Complete Weapon” and “Complete Muffler or Silencer Device”
  - E. Definition of “Privately Made Firearm”
  - F. Definition of “Importer’s or Manufacturer’s Serial Number”
  - G. Definition of “Gunsmith”
  - H. Marking Requirements for Firearms
  - I. Recordkeeping
  - J. Record Retention
  - K. Effect on Prior ATF Rulings and Procedures
  - L. Severability
- VI. Statutory and Executive Order Review
  - A. Executive Orders 12866 and 13563
  - B. Executive Order 13132
  - C. Executive Order 12988
  - D. Regulatory Flexibility Act
  - E. Small Business Regulatory Enforcement Fairness Act of 1996
  - F. Congressional Review Act
  - G. Unfunded Mandates Reform Act of 1995
  - H. Paperwork Reduction Act of 1995

**I. Executive Summary**

*A. Summary of the Regulatory Action*

There are no statutory definitions for the terms “frame” or “receiver” in the Gun Control Act of 1968 (“GCA”) or the National Firearms Act of 1934 (“NFA”). To implement these statutes, the terms “firearm frame or receiver” and “frame or receiver” were defined in regulations to mean “[t]hat part of a firearm which provides housing for the hammer, bolt or breechblock, and firing mechanism, and which is usually threaded at its forward portion to receive the barrel.” 27 CFR 478.11 (implementing GCA, Title I); 27 CFR 479.11<sup>1</sup> (implementing GCA, Title II). These definitions were meant to provide direction as to which portion of a weapon is the frame or receiver for purposes of licensing, serialization, and recordkeeping, thereby ensuring that a component necessary for the functioning of the weapon could be traced if later involved in a crime.

However, a restrictive application of these definitions would not describe the frame or receiver of most firearms

<sup>1</sup> The definition of “frame or receiver” in section 479.11 differs slightly from the definition in section 478.11 in that it omits an Oxford comma between “bolt or breechblock” and “firing mechanism.”

currently in circulation in the United States. Most modern weapon designs, including semiautomatic rifles and pistols with detachable magazines, have a split or multi-piece receiver where the relevant fire control components are housed by more than one part of the weapon (*e.g.*, the upper receiver and lower receiver of an AR-15 rifle), or incorporate a striker to fire the weapon, rather than a hammer.

In the past few years, some courts have treated the regulatory definition of “firearm frame or receiver” as inflexible when applied to the lower portion of the AR-15-type rifle, one of the most popular firearms in the United States. If broadly followed, that result could mean that as many as 90 percent of all firearms (*i.e.*, with split frames or receivers, or striker-fired) in the United States would not have any frame or receiver subject to regulation. Furthermore, technological advances have also made it easier for companies to sell firearm parts kits, standalone frame or receiver parts, and easy-to-complete frames or receivers to unlicensed persons, without maintaining any records or conducting a background check. These parts kits, standalone frame or receiver parts, or partially complete frames or receivers enable individuals to make firearms quickly and easily. Such privately made firearms (“PMFs”), when made for personal use, are not required by the GCA to have a serial number placed on the frame or receiver, making it difficult for law enforcement to determine where, by whom, or when they were manufactured, and to whom they were sold or otherwise transferred. Because of the difficulty with tracing illegally sold or distributed PMFs, those firearms are also commonly referred to as “ghost guns.”

For these many reasons, ATF is promulgating a rule that would bring clarity to the definition of “frame or receiver” by providing an updated, more comprehensive definition. On May 21, 2021, the Department published a Notice of Proposed Rulemaking (“NPRM”) in the **Federal Register**, 86 FR 27720, proposing to redefine the term “frame or receiver” as that which provides housing or a structure to hold or integrate one or more fire control components. In light of the comments received, this final rule revises the proposed definition of “frame or receiver” so that a “frame” is applicable to a handgun, and variants thereof, and a “receiver” is applicable to a rifle, shotgun, or projectile weapon other than a handgun, and variants thereof. Moreover, “frame or receiver” will be defined to describe only a single part

that provides housing or a structure for one specific, primary fire control component of weapons that expel a projectile, or one specific, primary internal sound reduction component of firearm mufflers or silencers. The final rule also defines the meaning of “variants” and “variants thereof.” The final rule provides detailed examples along with pictures identifying the frame or receiver of a variety of common models under the updated definition. The final rule also exempts from the new definitions and marking requirements existing split frame or receiver designs in which a part was previously classified by ATF as the firearm “frame or receiver” and provides examples and pictures of select exempted frames or receivers, such as AR-15/M-16 variant firearms. The only exception to “grandfathering” will be for partially complete, disassembled, or nonfunctional frames or receivers, including weapon or frame or receiver parts kits, that ATF did not classify as firearm “frames or receivers” as defined prior to this rule.

The final rule also specifies, with more clarity and examples than the NPRM, how these terms apply to multi-piece frames or receivers (*i.e.*, those that may be disassembled into multiple modular subparts), to firearm mufflers and silencers, to partially complete, disassembled, or nonfunctional frames or receivers, including frame or receiver parts kits, and to frames or receivers that are destroyed. The final rule also provides detailed examples of when such items are considered readily completed, assembled, restored, or otherwise “converted” to function as a frame or receiver. At the same time, the final rule makes clear that articles that have not yet reached a stage of manufacture where they are clearly identifiable as an unfinished component of a frame or receiver (*e.g.*, unformed blocks of metal, liquid polymers, or other raw materials) are not frames or receivers.

Consistent with the GCA, and to ensure proper licensing, marking, recordkeeping, and background checks with respect to certain weapon parts kits, the final rule adopts the proposed clarification of the term “firearm” to include weapon (*e.g.*, pistol, revolver, rifle, or shotgun) parts kits that are designed to or may readily be completed, assembled, restored, or otherwise converted to expel a projectile by the action of an explosive. This rule also finalizes, with minor changes, the proposed definition of “privately made firearm.” It amends the regulations to require that all firearms privately manufactured or “made” by

nonlicensees without identifying markings that are taken into inventory by licensees be identified (or marked) and recorded so that they may be traced by law enforcement through their records if they are later involved in crime. As with the NPRM, the final rule does not mandate unlicensed persons to mark their own PMFs for personal use, or when they occasionally acquire them for a personal collection or sell or transfer them from a personal collection to unlicensed in-State residents consistent with Federal, State, and local law.

In addition, the rule finalizes the proposed amendments to the term “gunsmith” to include persons who engage in the business of identifying firearms for nonlicensees, thus ensuring greater access to professional marking services for PMFs. The final rule clarifies the gunsmithing rules proposed in the NPRM by stating the following: (1) Licensed firearms dealers (in addition to licensed manufacturers and importers) may conduct same-day adjustments or repairs of all firearms, including PMFs, without taking them into inventory, provided they are returned to the person from whom they were received; (2) nonlicensees may mark PMFs for a licensee under the licensee’s direct supervision; and (3) licensees may adopt an existing unique identification number previously placed on a PMF by a nonlicensee under certain conditions.

In response to comments, the final rule permits licensed manufacturers to adopt the serial number and other identifying markings previously placed on a firearm without a variance from ATF, provided the firearm has not been sold, shipped, or otherwise disposed of to a person who is not a licensed manufacturer, superseding ATF Ruling 2009–5. The rule permits licensed manufacturers to perform gunsmithing services on existing, marked firearms without marking or obtaining a marking variance, superseding ATF Ruling 2010–10. It also finalizes, with some modifications, the proposed definition of the term “importer’s or manufacturer’s serial number” to help ensure that the serial number and associated identifying markings required to be placed on a firearm, including those placed on a PMF or an ATF-issued serial number,<sup>2</sup> are considered the “importer’s or manufacturer’s serial number” protected by 18 U.S.C. 922(k), which prohibits

<sup>2</sup> ATF occasionally issues serial numbers for placement on firearms in which the serial numbers were not originally placed, *see* 26 U.S.C. 5842(b), or were accidentally removed, damaged, or worn due to routine use or other innocent reason.

possession or receipt of a firearm that has had the importer’s or manufacturer’s serial number removed, obliterated, or altered.

The final rule adopts, with minor clarifying changes, the proposed clarifications to the marking and recordkeeping requirements for licensees. First, the rule finalizes the definitions for “complete weapon” and “complete muffler or silencer device,” and adds a new definition for “multi-piece frame or receiver” under the new definition of “frame or receiver.” The rule also specifies a reasonable time period in which a complete weapon or a complete muffler or silencer device, or the frame or receiver of a weapon or device (including a modular subpart of a multi-piece frame or receiver), must be marked with a serial number and other identifying information and recorded. Second, the rule finalizes the proposed updates to the information required to be marked on the frame or receiver, clarifies the meaning of the marking terms “identify,” “legibly,” and “conspicuously,” and authorizes firearms licensees to adopt identifying markings in the manufacturing process. Third, the rule finalizes the proposal to require all licensees to consolidate their records of manufacture, acquisition, and disposition of firearms, and to eliminate duplicate recordkeeping entries. Fourth, with respect to parts defined as firearm mufflers or silencers, which are difficult to mark and record, this rule finalizes with minor clarifying changes the proposed amendments that allow for them to be transferred between licensees qualified under the NFA for purposes of further manufacture or repair of complete devices without immediately marking and registering them in the National Firearms Registration and Transfer Record (“NFRTR”). Fifth, the rule finalizes with minor clarifying changes the proposed amendments that set forth the process by which persons may voluntarily seek a determination from ATF on whether an item or kit they wish to manufacture or possess is a firearm or armor piercing ammunition subject to marking, recordkeeping, and other applicable Federal laws and regulations. These amendments to the regulations will help ensure that firearms can be traced efficiently and effectively by law enforcement through the records of licensees, and help prevent the acquisition of easy-to-complete firearms by prohibited persons and terrorists.

Lastly, the rule finalizes with minor changes the proposed requirement that all licensees retain their records until the business or licensed activity is discontinued, either on paper or in an

electronic format approved by the Director of ATF (“Director”), at the business or collection premises readily accessible for inspection. This includes authorization of licensees to store their “closed out” paper records and forms older than 20 years at a separate warehouse, which would be considered part of the business or collection premises for this purpose and subject to inspection. These provisions will enhance public safety by ensuring that acquisition and disposition records of all active licensees are not destroyed after 20 years and will remain available to law enforcement for tracing purposes.

### B. Summary of Costs and Benefits

The final rule clarifies which firearms are subject to regulation under the GCA and NFA and associated licensing, marking, and recordkeeping requirements. The rule requires persons who engage in the business of dealing in weapon and frame or receiver parts kits defined as firearms to be licensed, mark the frames or receivers within such kits with serial numbers and other marks of identification, and maintain records of their acquisition and disposition. The provisions of these statutes and implementing regulations are designed to increase public safety by, among other things, preventing prohibited persons from acquiring firearms and allowing law enforcement to trace firearms involved in crime.

To minimize disruption and cost to the licensed firearms industry as much as possible, and in keeping with the public safety goals of the rule, this rule grandfathered existing complete frame or receiver designs previously determined by the Director to be the firearm “frame or receiver” of a given weapon. It does not grandfather partially complete, disassembled, or nonfunctional frames or receivers, including weapon or frame or receiver parts kits, that ATF did not classify as firearm “frames or receivers” as previously defined. ATF estimates that the 7 percent annualized cost of this rule is \$14.3 million.

## II. Background

The Attorney General is responsible for enforcing the Gun Control Act of 1968, as amended, and the National Firearms Act of 1934, as amended.<sup>3</sup> This responsibility includes the authority to

<sup>3</sup> NFA provisions still refer to the “Secretary of the Treasury.” See generally 26 U.S.C. ch. 53. However, the Homeland Security Act of 2002, Public Law 107–296, 116 Stat. 2135, transferred the functions of ATF from the Department of the Treasury to the Department of Justice, under the general authority of the Attorney General. 26 U.S.C. 7801(a)(2); 28 U.S.C. 599A(c)(1). Thus, for ease of reference, this final rule refers to the Attorney General throughout.

promulgate regulations necessary to enforce the provisions of the GCA and NFA. See 18 U.S.C. 926(a); 26 U.S.C. 7801(a)(2)(A), 7805(a).<sup>4</sup> Congress and the Attorney General have delegated the responsibility for administering and enforcing the GCA and NFA to the Director of ATF, subject to the direction of the Attorney General and the Deputy Attorney General. See 26 U.S.C. 7801(a)(2); 28 U.S.C. 599A(b)(1), (c)(1); 28 CFR 0.130(a)(1)–(2); T.D. Order No. 221(2)(a), (d), 37 FR 11696–97 (June 10, 1972). Accordingly, the Department and ATF have promulgated regulations to implement the GCA and NFA. See 27 CFR parts 478, 479.

On May 21, 2021, the Department published in the **Federal Register** a Notice of Proposed Rulemaking (“NPRM”) entitled “Definition of ‘Frame or Receiver’ and Identification of Firearms,” 86 FR 27720, proposing changes to various regulations in 27 CFR parts 447, 478, and 479. The comment period for the proposed rule concluded on August 19, 2021, and ATF received 290,031 comments.

The NPRM provided a comprehensive explanation of the passage of the Federal Firearms Act of 1938 (“FFA”), Public Law 75–785, 52 Stat. 1250, its repeal, and the subsequent legislative history and context leading to Congress’s passage of the GCA in 1968, as well as the promulgation of the definitions for “frame or receiver” that ATF and the firearms industry have relied on for more than 50 years.<sup>5</sup> 86 FR at 27720–21. The GCA at 18 U.S.C. 921(a)(3) defines the term “firearm” to include not only a weapon that will, is designed to, or may readily be converted to expel a projectile, but also the “frame” or “receiver” of any such weapon. 18 U.S.C. 921(a)(3)(A), (B). Because frames or receivers are included in the definition of “firearm,” any person who engages in the business of manufacturing, importing, or dealing in frames or receivers must obtain a license from ATF. 18 U.S.C. 922(a)(1)(A), 923(a). Each licensed manufacturer or importer must “identify by means of a serial number engraved or cast on the receiver or frame of the weapon, in such manner as the Attorney General shall by regulations prescribe, each firearm imported or manufactured by such importer or manufacturer.”<sup>6</sup> 18

<sup>4</sup> See also footnote 82, *infra*, for specific grants of rulemaking authority.

<sup>5</sup> The Omnibus Crime Control and Safe Streets Act of 1968 repealed the FFA and was then incorporated into and expanded by the GCA. Public Law 90–351, secs. 906–07, 82 Stat. 197, 234–35 (1968); Public Law 90–618, 82 Stat. 1213 (1968).

<sup>6</sup> Additionally, a firearm frame or receiver that is not a component part of a complete weapon at the

U.S.C. 923(i); see 27 CFR 478.92, 479.102. Licensed manufacturers and importers must also maintain permanent records of production or importation, as well as their receipt, sale, or other disposition of firearms, including frames or receivers. 18 U.S.C. 923(g)(1)(A); 27 CFR 478.122, 478.123.

The GCA does not define the terms “frame” or “receiver” to implement the statute, but frames or receivers are the primary structural components of a firearm to which fire control components are attached.<sup>7</sup> After the GCA was enacted, the terms “firearm frame or receiver” and “frame or receiver” were defined as “that part of a firearm which provides housing for the hammer, bolt or breechblock, and firing mechanism, and which is usually threaded at its forward portion to receive the barrel.” 27 CFR 478.11 (implementing GCA, Title I);<sup>8</sup> 27 CFR 479.11 (implementing GCA, Title II).<sup>9</sup> The intent in promulgating these definitions was to inform the public and industry as to which portion of a firearm was the frame or receiver for purposes of licensing, serialization, and recordkeeping, thus ensuring that a necessary component of the weapon could be traced if later involved in a crime.

The NPRM discussed that at the time the regulatory definitions were promulgated, single-framed firearms such as revolvers and break-open shotguns were far more prevalent for civilian (*i.e.*, not military or law enforcement) use in the United States than split receiver weapons, such as semiautomatic rifles and pistols with detachable magazines. Single-framed firearms incorporate the hammer, bolt or breechblock, and firing mechanism within the same housing. 86 FR at

time it is sold, shipped, or disposed of must be identified in the manner prescribed with a serial number and all of the other required markings. 27 CFR 478.92(a)(2), 479.102(e); ATF Rule 2012–1.

<sup>7</sup> See Webster’s Third New International Dictionary 902, 1894 (1971) (a “frame” is “the basic unit of a handgun which serves as a mounting for the barrel and operating parts of the arm”; “receiver” means “the metal frame in which the action of a firearm is fitted and to which the breech end of the barrel is attached”); John Olson, Olson’s Encyclopedia of Small Arms 72 (1985) (the term “frame” means “the basic structure and principal component of a firearm”); Steindler’s New Firearms Dictionary, p. 209 (1985) (“receiver” means “that part of a rifle or shotgun . . . that houses the bolt, firing pin, mainspring, trigger group, and magazine or ammunition feed system. The barrel is threaded into the somewhat enlarged forward part of the receiver, called the receiver ring. At the rear of the receiver, the butt or stock is fastened. In semiautomatic pistols, the frame or housing is sometimes referred to as the receiver”).

<sup>8</sup> See 33 FR 18558 (Dec. 14, 1968) (formerly 26 CFR 178.11).

<sup>9</sup> See 36 FR 14257 (Aug. 3, 1971) (formerly 26 CFR 179.11).

27721. Over time, split receiver firearms became popular for civilian use, such as the AR-15 semiautomatic rifle (upper receiver and lower receiver), Glock semiautomatic pistol (upper slide assembly and lower grip module), and Sig Sauer P320 pistol (M17/18 as adopted by the U.S. military) (upper slide assembly, chassis, and lower grip module). And more firearm manufacturers began incorporating a striker-fired mechanism, rather than a “hammer,” in the firing design, such as in the Glock pistol. *Id.*

#### A. ATF’s Application of the Definitions to Split Frames and Receivers

The NPRM explained that ATF’s regulatory definitions of “frame or receiver” do not expressly capture these types of firearms (*i.e.*, split frames or receivers) that now constitute the majority of firearms in the United States.<sup>10</sup> However, ATF’s position has long been that the weapon “should be examined with a view toward determining if [either] the upper or lower half of the receiver more nearly fits the legal definition of ‘receiver,’” and more specifically, for machineguns, whether the upper or lower portion has the ability to accept machinegun parts.<sup>11 12</sup> The NPRM listed the variety of factors ATF has considered when making determinations for firearm classifications under the GCA and NFA regarding which part of a firearm is the frame or receiver, given that neither a split nor a multi-piece receiver has a

<sup>10</sup> *United States v. Rowold*, 429 F. Supp. 3d 469 (N.D. Ohio 2019), Testimony of ATF Firearms Enforcement Officer Daniel Hoffman at Doc. No. 60, Hrg. Tr., Page ID 557 (approximately 10 percent of currently manufactured firearms in the United States include at least three components in the frame or receiver definition), and Defense Expert Daniel O’Kelly at Doc. No. 60, Hrg. Tr., Page ID 482 (“90 some percent of [semiautomatic pistols] do not have a part which has more than one of these four elements in it and, therefore, don’t qualify, according to the definition in the CFR.”).

<sup>11</sup> ATF Internal Revenue Service Memorandum #21208 (Mar. 1, 1971) (lower portion of the M-16 is the frame or receiver because it comes closest to meeting the definition of frame or receiver in 26 CFR 178.11 (now 27 CFR 478.11), and is the receiver of a machinegun as defined in the NFA); ATF Memorandum #22334 (Jan. 24, 1977) (upper half of the FN-FAL rifle is the frame or receiver because it was designed to accept the components that allow fully automatic fire). The ability to accept machinegun parts is considered because both the GCA and the NFA regulate machinegun receivers as “machineguns.” See 18 U.S.C. 921(a)(23); 26 U.S.C. 5845(b) (“The term [“machinegun”] shall also include the frame or receiver of any such weapon [which shoots is designed to shoot, or can be readily restored to shoot, automatically more than one shot, without manual reloading, by a single function of the trigger.”]).

<sup>12</sup> Regulations implementing the relevant statutes spell the term “machine gun” rather than “machinegun.” *E.g.*, 27 CFR 478.11, 479.11. For convenience, this rule uses “machinegun,” except when quoting a source to the contrary.

portion of its design that falls within the precise wording of the existing regulatory definition. 86 FR at 27721.

Indeed, the current definitions were never intended, or understood, to be exhaustive. The Department discussed in the NPRM the existing law and congressional intent recognizing that the definition of “frame or receiver” need not be limited to a strict application of the regulation. *Id.* at 27721–22. At the time the current definitions were adopted, there were numerous models of firearms that did not contain a part that fully met the regulatory definition of “frame or receiver,” such as the Colt 1911, FN-FAL, and the AR-15/M-16, all of which were originally manufactured almost exclusively for military use. ATF has long applied the factors stated in the NPRM when determining which component of those weapons qualifies as the frame or receiver.<sup>13</sup>

While ATF for decades has classified the lower receiver of the AR-15 rifle as a “frame or receiver,” some courts recently have treated the regulatory definition as inflexible when applied to the lower portion of the AR-15-type rifle, which is the semiautomatic version of the M-16-type machinegun originally designed for the U.S. military. That was because those courts have read the regulatory definition to mean that the lower portion of the AR-15 is not a “frame or receiver,” as it provides housing only for the hammer and firing mechanism, not the bolt or breechblock. See *United States v. Rowold*, 429 F. Supp. 3d 469, 475–76 (N.D. Ohio 2019). (“The language of the regulatory definition in § 478.11 lends itself to only one interpretation: Namely, that under the GCA, the receiver of a firearm must be a single unit that holds three, not two components: (1) The hammer, (2) the bolt or breechblock, and (3) the firing mechanism.”); see also *United States v. Roh*, 8:14-cr-00167-JVS, Minute Order p. 6 (C.D. Cal. July 27, 2020); *United States v. Jimenez*, 19 F. Supp. 3d 1038, 1041 (N.D. Cal. 2016).

The NPRM explained that, if broadly followed, these courts’ interpretation of ATF’s regulations could mean that as many as 90 percent of all firearms now in the United States would not have any frame or receiver subject to regulation under the current definitions.<sup>14</sup> Those firearms would include numerous widely available models, such as Glock-type and Sig Sauer P320<sup>15</sup> pistols, that

do not utilize a hammer—a named component—in the existing regulatory definition—in the firing sequence. Such a narrow interpretation of what constitutes a frame or receiver would allow persons to avoid obtaining a license to engage in the business of manufacturing or importing upper or lower frames or receivers, which would further allow those persons to avoid the GCA’s marking, recordkeeping, and background check requirements pertaining to upper or lower frames or receivers. See 86 FR at 27722. In turn, prohibited persons may more easily and without a background check acquire upper and lower receivers that can quickly be assembled into semiautomatic weapons.<sup>16</sup> Moreover, law enforcement’s ability to trace semiautomatic firearms later used in crime would be severely impeded if no portion of split or multi-piece frames or receivers were subject to any existing regulations as described. This result would undermine the intent of Congress in requiring the frame or receiver of every firearm to be identified, see 18 U.S.C. 923(i), and regulated as a firearm, see 18 U.S.C. 921(a)(3)(B).

#### B. Privately Made Firearms

The NPRM explained that technological advances have also made it easier for companies to sell firearm parts kits, standalone frame or receiver parts, or partially complete frames or receivers to unlicensed persons, posing significant challenges to the regulation of frames and receivers and enabling prohibited individuals to easily make firearms at home, especially if aided by personally owned equipment or 3D printers. These privately made firearms, commonly referred to as “ghost guns,” are not required by the GCA to have a

purchasing up to 500,000 of these striker-fired pistols. Matthew Cox & Hope Hodge Seck, *Army Picks Sig Sauer’s P320 Handgun to Replace M9 Service Pistol*, *Military.com* (Jan. 19, 2017), available at <https://www.military.com/daily-news/2017/01/19/army-picks-sig-sauer-replace-m9-service-pistol.html> (last visited Mar. 22, 2022); Jared Keller, *Every U.S. military branch is about to get its hands on the Army’s new sidearm of choice*, *Taskandpurpose.com* (Nov. 18, 2020), available at <https://taskandpurpose.com/military-tech/modular-handgun-system-fielding> (last visited Mar. 22, 2022) (Sig Sauer delivered its 200,000th P320-variant pistol to the military despite the obstacles posed by the novel coronavirus).

<sup>16</sup> See Jake Bleiberg & Stefanie Dazio, *Design of AR-15 could derail charges tied to popular rifle*, *APnews.com* (Jan. 13, 2020), available at <https://apnews.com/article/396bbdbf4963a28bda99e7793ee6366> (last visited Mar. 22, 2022); Dan Morse & Jasmine Hilton, *Magruder [High School] student bought ‘ghost gun’ components online before wounding classmate*, *Wash. Post* (Jan. 24, 2022), available at <https://www.washingtonpost.com/dc-md-va/2022/01/24/magruder-shooting-teen-jailed/> (last visited Mar. 22, 2022).

<sup>13</sup> See footnote 11, *supra*.

<sup>14</sup> See footnote 10, *supra*.

<sup>15</sup> The United States military services have adopted variants of the Sig Sauer P320 as their official sidearm, and are in the process of

serial number placed on the frame or receiver when made for personal use. When PMFs are relinquished by their owners, enter commerce, and are later recovered and submitted for tracing, the absence of markings on PMFs makes it extremely difficult for law enforcement to determine where, by whom, or when they were manufactured, and to whom they were sold or otherwise disposed.

The NPRM discussed the substantial increase in the number of PMFs recovered from crime scenes throughout the country in recent years.<sup>17</sup> From January 1, 2016, through December 31, 2021, there were approximately 45,240 suspected PMFs reported to ATF as having been recovered by law enforcement from potential crime scenes, including 692 homicides or

attempted homicides (*not* including suicides), and which ATF attempted to trace. Broken down by calendar year, the total annual numbers of suspected PMFs recovered show significant proliferation over the past six years: 2016: 1,758; 2017: 2,552; 2018: 3,960; 2019: 7,517; 2020: 10,109; 2021: 19,344.<sup>18 19</sup>

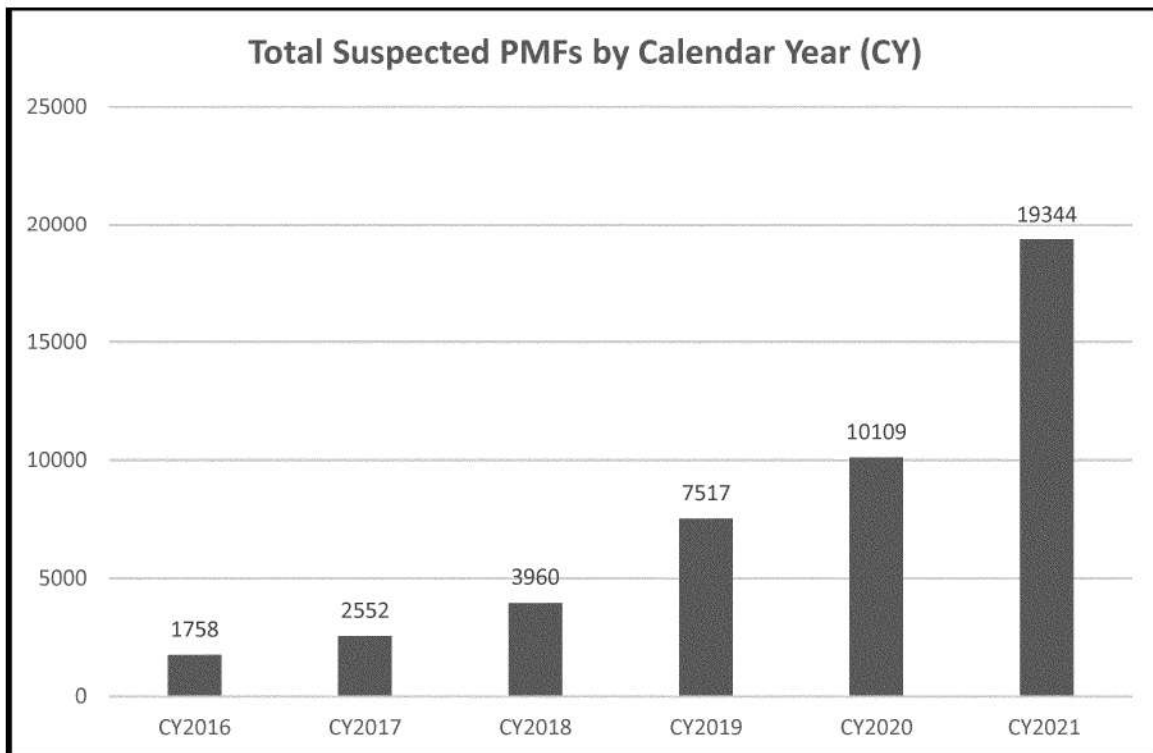

Numerous criminal cases have been brought by the Department to counter the illegal trafficking of unserialized

privately completed and assembled weapons, the possession of such

<sup>17</sup> 86 FR at 27722 n.17. See also Erik von Ancken, *Untraceable 'Ghost Guns' sold across Central Florida*, WKMG-TV Orlando (Nov. 15, 2016), available at <https://www.clickorlando.com/getting-results/2016/11/15/untraceable-ghost-guns-sold-across-central-florida> (last visited Mar. 22, 2022); Nicholas J. Simons, *Ghost Guns: A Haunting New Reality*, Rockefeller Institute of Justice (2021), available at <https://rockinst.org/wp-content/uploads/2021/04/210413-Ghost-Guns-web.pdf> (last visited Mar. 22, 2022); Travis Taniguchi et al., *The Proliferation of Ghost Guns: Regulation Gaps and Challenges for Law Enforcement*, National Police Foundation (2021), available at [https://www.policefoundation.org/wp-content/uploads/2021/08/NPF\\_The-Proliferation-of-Ghost-Guns\\_Final\\_2021.pdf](https://www.policefoundation.org/wp-content/uploads/2021/08/NPF_The-Proliferation-of-Ghost-Guns_Final_2021.pdf) (last visited Mar. 22, 2022); Shanzeh Ahmad & Jeremy Gomer, 'We're seeing an explosion.' Sheriff Tom Dart, state Sen. Jacqueline Collins take aim at ghost guns, propose legislation to ban the untraceable weapons, Chi. Trib. (Oct. 14, 2021), available at <https://www.chicagotribune.com/news/breaking/ct-cook-county-sheriff-dart-ghost-gun-legislation-20211014-whvhwv5aangmtafe27gpllqtvu-story.html> (last visited Mar. 22, 2022); Brian X. McCrone, '3 Pipes Turned into a Shotgun': Nearly 1-in-10 Guns Seized in Philly Are Homemade, NBC10 Philadelphia (Oct.

7, 2021), available at <https://www.nbcphiladelphia.com/news/local/three-metal-pipes-turned-into-a-shotgun-nearly-1-in-10-guns-seized-in-philly-are-homemade/2983066> (last visited Mar. 22, 2022); Kevin Rector, *LAPD declares 'ghost guns' an 'epidemic,' citing 400% increase in seizures*, L.A. Times (Oct. 15, 2021), available at <https://www.latimes.com/california/story/2021-10-15/lapd-says-ghost-guns-an-epidemic-with-seizures-up-400-since-2017> (last visited Mar. 22, 2022); Glenn Thrush, 'Ghost Guns': Firearm Kits Bought Online Fuel Epidemic of Violence, N.Y. Times (Nov. 14, 2021), available at <https://www.nytimes.com/2021/11/14/us/ghost-guns-homemade-firearms.html> (last visited Mar. 22, 2022).

<sup>18</sup> Source: ATF Office of Strategic Intelligence and Information. These numbers (as of January 21, 2022) are likely far lower than the actual number of PMFs recovered from crime scenes because some law enforcement departments incorrectly trace some PMFs as commercially manufactured firearms, or may not see a need to use their resources to attempt to trace firearms with no serial numbers or other identifiable markings. The term "suspected PMF" is used because of the difficulty of getting law enforcement officials to uniformly enter PMF trace information into ATF's electronic tracing system

("eTrace"), resulting in reporting inconsistencies of PMFs involved in crime. For example, often PMFs resemble commercially manufactured firearms, or incorporate parts from commercially manufactured firearms bearing that manufacturer's name, so some firearms suspected of being PMFs were entered into eTrace using a commercial manufacturer's name rather than as one privately made by individuals. The term "potential crime scenes" is used because ATF does not know if the firearm being traced by the law enforcement agency was found at a crime scene as opposed to one recovered by law enforcement that had been stolen or otherwise not from the scene of a crime. This is because the recovery location or correlated crime is not always communicated by the agency to ATF in the tracing process.

<sup>19</sup> The total number of suspected PMFs is greater than the 23,906 originally queried and reported as of March 4, 2021, in the NPRM, 86 FR at 27722-23, due, not only to the addition of CY 2021 data, but also to traces being updated with more specificity regarding the firearm description since that date, and the inclusion of all suspected PMFs recovered within this time frame regardless of when the trace was entered.

weapons by prohibited persons, and other related Federal crimes.<sup>20</sup>

<sup>20</sup>86 FR 27723 n.19. See also *Dark Web Gun Trafficker from Nevada County Pleads Guilty to Unlawful Dealing in Firearms*, DOJ/OPA (June 22, 2018), available at <https://www.justice.gov/usao-edca/pr/dark-web-gun-trafficker-nevada-county-pleads-guilty-unlawful-dealing-firearms>; *Burlington Man Pleads Guilty to Ammunition Charge*, DOJ/OPA (Dec. 12, 2018), available at <https://www.justice.gov/usao-ma/pr/burlington-man-pleads-guilty-ammunition-charge>; *Burlington Man Sentenced For Ammunition Charge*, DOJ/OPA (Mar. 19, 2019), available at <https://www.justice.gov/usao-ma/pr/burlington-man-sentenced-ammunition-charge>; *Indiana Residents Indicted on Terrorism and Firearms Charges*, DOJ/OPA (July 11, 2019), available at <https://www.justice.gov/opa/pr/indiana-residents-indicted-terrorism-and-firearms-charges>; *Las Vegas Man Charged For Illegally Engaging In The Business Of Manufacturing Machine Guns Without A License*, DOJ/OPA (Sept. 4, 2019), available at <https://www.justice.gov/usao-nv/pr/las-vegas-man-charged-illegally-engaging-business-manufacturing-machine-guns-without>; *Two Stockton Residents Sentenced for Firearms Offenses*, DOJ/OPA (Nov. 21, 2019), available at <https://www.justice.gov/usao-edca/pr/two-stockton-residents-sentenced-firearms-offenses>; *Denver Gang Member Sentenced To Over 15 Years In Federal Prison For Making And Selling Dozens Of High Powered Guns, Including Machine Guns And Silencers*, DOJ/OPA (Nov. 22, 2019), available at <https://www.justice.gov/usao-co/pr/denver-gang-member-sentenced-over-15-years-federal-prison-making-and-selling-dozens-high>; *Cedar Rapids Man Pleads Guilty to Drug Trafficking and Possessing Machineguns and a Pipe Bomb*, DOJ/OPA (Jan. 21, 2020), available at <https://www.justice.gov/usao-ndia/pr/cedar-rapids-man-pleads-guilty-drug-trafficking-and-possessing-machineguns-and-pipe>; *Indictment Charges 15 Members of a Los Angeles Drug Trafficking Ring that Distributed Heroin, Methamphetamine and Cocaine*, DOJ/OPA (Feb. 12, 2020), available at <https://www.justice.gov/usao-cdca/pr/indictment-charges-15-members-los-angeles-drug-trafficking-ring-distributed-heroin>; *Two Queens Men Charged After Buying Three Illegally Defaced Firearms and Two Assault Rifles*, DOJ/OPA (May 13, 2020), available at <https://www.justice.gov/usao-edny/pr/two-queens-men-charged-after-buying-three-illegally-defaced-firearms-and-two-assault>; *Second Defendant Charged with Murder in New Indictment in Case of Man Found Dead in Pacific Ocean after Being Shot on a Boat*, DOJ/OPA (June 25, 2020), available at <https://www.justice.gov/usao-cdca/pr/second-defendant-charged-murder-new-indictment-case-man-found-dead-pacific-ocean-after>; *Fishers residents indicted on terrorism and firearms charges*, DOJ/OPA (July 12, 2019), available at <https://www.justice.gov/usao-sdin/pr/fishers-residents-indicted-terrorism-and-firearms-charges>; *Outlaws Motorcycle Club Regional President Pleads Guilty to Firearms Charges*, DOJ/OPA (July 15, 2020), available at <https://www.justice.gov/usao-ma/pr/outlaws-motorcycle-club-regional-president-pleads-guilty-firearms-charges>; *Sun Valley Man Indicted on Federal Narcotics Charges and Weapons Offenses, including Possession of Ghost Gun and Grenade Launcher*, DOJ/OPA (July 23, 2020), available at <https://www.justice.gov/usao-cdca/pr/sun-valley-man-indicted-federal-narcotics-charges-and-weapons-offenses-including>; *Seven Defendants Arrested and Charged in Conspiracy to Possess and Carry Firearms in Furtherance of Drug Trafficking*, DOJ/OPA (Sept. 3, 2020), available at <https://www.justice.gov/usao-dc/pr/seven-defendants-arrested-and-charged-conspiracy-possess-and-carry-firearms-furtherance>; *Takedown Completes Arrests of 15 Alleged Drug Traffickers in Syracuse Area*, DOJ/OPA (Sept. 17, 2020), available at <https://www.justice.gov/usao-ndny/pr/takedown-completes-arrests-15-alleged-drug-traffickers>

*Syracuse-area; Three Members of Gardena Street Gang Charged in Federal Racketeering Case Alleging Murder of Man Outside His Home*, DOJ/OPA (Dec. 2, 2020), available at <https://www.justice.gov/usao-cdca/pr/three-members-gardena-street-gang-charged-federal-racketeering-case-alleging-murder-man>; *Syracuse Man Pleads Guilty to Brokering Illegal Gun Sales*, DOJ/OPA (Dec. 9, 2020), available at <https://www.justice.gov/usao-ndny/pr/syracuse-man-pleads-guilty-brokering-illegal-gun-sales>; *Gang Member Sentenced to More Than 7 Years in Prison for Gun and Drug Offenses*, DOJ/OPA (Feb. 17, 2021), available at <https://www.justice.gov/usao-ct/pr/gang-member-sentenced-more-7-years-prison-gun-and-drug-offenses>; *Man Sentenced for Attempting to Board International Flight with a Loaded Firearm*, DOJ/OPA (Mar. 12, 2021), available at <https://www.justice.gov/usao-sdca/pr/man-sentenced-attempting-board-international-flight-loaded-firearm>; *Vacaville Man Sentenced to over 4 Years in Prison for Unlawfully Possessing Ammunition as a Felon*, DOJ/OPA (May 4, 2021), available at <https://www.justice.gov/usao-edca/pr/vacaville-man-sentenced-over-4-years-prison-unlawfully-possessing-ammunition-felon>; *Big Island man arrested on methamphetamine and firearm charges*, DOJ/OPA (May 18, 2021), available at <https://www.justice.gov/usao-hi/pr/big-island-man-arrested-methamphetamine-and-firearm-charges>; *Fresno Gang Member Faces Federal Firearms Charge*, DOJ/OPA (June 3, 2021), available at <https://www.justice.gov/usao-edca/pr/fresno-gang-member-faces-federal-firearms-charge>; *Temple Hills Man Sentenced To Three And A Half Years In Federal Prison For Trafficking Of Ghost Guns*, DOJ/OPA (June 4, 2021), available at <https://www.justice.gov/usao-md/pr/temple-hills-man-sentenced-three-and-half-years-federal-prison-trafficking-ghost-guns>; *Septuagenarian charged with manufacturing "ghost guns"*, DOJ/OPA (June 15, 2021), available at <https://www.justice.gov/usao-sdtx/pr/septuagenarian-charged-manufacturing-ghost-guns>; *Convicted Gun Trafficker Pleads Guilty to Firearms Charges*, DOJ/OPA (June 22, 2021), available at <https://www.justice.gov/usao-ndny/pr/convicted-gun-trafficker-pleads-guilty-firearms-charges>; *Barnstable Man Charged with Firearm Trafficking*, DOJ/OPA (June 22, 2021), available at <https://www.justice.gov/usao-ma/pr/barnstable-man-charged-firearm-trafficking>; *Laplace Man Pleads Guilty to Being Felon in Possession of Ammunition*, DOJ/OPA (June 25, 2021), available at <https://www.justice.gov/usao-edla/pr/laplace-man-pleads-guilty-being-felon-possession-ammunition>; *Felon Pleads Guilty to Possession of Ghost Guns and Conspiracy to Commit Wire Fraud*, DOJ/OPA (June 28, 2021), available at <https://www.justice.gov/usao-md/pr/felon-pleads-guilty-possession-ghost-guns-and-conspiracy-commit-wire-fraud>; *Syracuse Man Sentenced to Seven Years in Federal Prison for Brokering Illegal Gun Sales*, DOJ/OPA (July 8, 2021), available at <https://www.justice.gov/usao-ndny/pr/syracuse-man-sentenced-seven-years-federal-prison-brokering-illegal-gun-sales>; *Federal Drug and Gun Charges Brought Against Fresno Man Accused of Dealing Fentanyl*, DOJ/OPA (July 15, 2021), available at <https://www.justice.gov/usao-edca/pr/federal-drug-and-gun-charges-brought-against-fresno-man-accused-dealing-fentanyl>; *Vineland Boys Gang Member Sentenced to 31 Years in Federal Prison for Racketeering Conspiracy, Attempted Murder of Rival Gangsters*, DOJ/OPA (July 22, 2021), available at <https://www.justice.gov/usao-cdca/pr/vineland-boys-gang-member-sentenced-31-years-federal-prison-racketeering-conspiracy>; *Hartford Man Charged with Illegally Possessing Firearm and Ammunition*, DOJ/OPA (July 23, 2021), available at <https://www.justice.gov/usao-ct/pr/hartford-man-charged-illegally-possessing-firearm-and-ammunition>; *Philadelphia Man Arrested on Murder-For-Hire Charges; Attempted Homicide in Southwest Philadelphia*

*Thwarted*, DOJ/OPA (July 26, 2021), available at <https://www.justice.gov/usao-edpa/pr/philadelphia-man-arrested-murder-hire-charges-attempted-homicide-southwest-philadelphia>; *Rensselaer County Felon Sentenced to 30 Months on Firearms Convictions*, DOJ/OPA (Aug. 10, 2021), available at <https://www.justice.gov/usao-ndny/pr/rensselaer-county-felon-sentenced-30-months-firearms-convictions>; *Three East Bay Men Charged With Conspiracy To Traffic Firearms*, DOJ/OPA (Aug. 16, 2021), available at <https://www.justice.gov/usao-ndca/pr/three-east-bay-men-charged-conspiracy-traffic-firearms>; *Raleigh Felon Sentenced After Pulling a Firearm on Officers During a Drug Investigation*, DOJ/OPA (Aug. 17, 2021), available at <https://www.justice.gov/usao-ednc/pr/raleigh-felon-sentenced-after-pulling-firearm-officers-during-drug-investigation>; *Buffalo Man Arrested, Charged With Manufacturing Ghost Guns*, DOJ/OPA (Aug. 20, 2021), available at <https://www.justice.gov/usao-wdny/pr/buffalo-man-arrested-charged-manufacturing-ghost-guns>; *Montgomery County Man Sentenced to 30 Months for Unlawfully Selling "Ghost Guns"*, DOJ/OPA (Sept. 2, 2021), available at <https://www.justice.gov/usao-ndny/pr/montgomery-county-man-sentenced-30-months-unlawfully-selling-ghost-guns>; *Three South Lake Tahoe Residents Charged with Drug Trafficking and Texas Man Charged with Trafficking Firearms*, DOJ/OPA (Aug. 23, 2021), available at <https://www.justice.gov/usao-edca/pr/three-south-lake-tahoe-residents-charged-drug-trafficking-and-texas-man-charged>; *New Mexico Man Who Sold "Ghost Guns" Indicted*, DOJ/OPA (Sept. 8, 2021), available at <https://www.justice.gov/usao-ndtx/pr/new-mexico-man-who-sold-ghost-guns-indicted>; *Fresno Men Indicted for Being Previously Convicted of Violent Crimes in Possession of Firearm and Ammunition*, DOJ/OPA (Sept. 16, 2021), available at <https://www.justice.gov/usao-edca/pr/fresno-men-indicted-being-previously-convicted-violent-crimes-possession-firearm-and>; *Connecticut Man Sentenced for Firearm Trafficking*, DOJ/OPA (Sept. 16, 2021), available at <https://www.justice.gov/usao-ma/pr/connecticut-man-sentenced-firearm-trafficking>; *Two Defendants Indicted For Oahu Game Room Robbery, Drug Trafficking, and "Ghost Gun" Possession*, DOJ/OPA (Sept. 17, 2021), available at <https://www.justice.gov/usao-hi/pr/two-defendants-indicted-oahu-game-room-robbery-drug-trafficking-and-ghost-gun-possession>; *D.C. Felon Sentenced to 30 Months In Federal Prison For Illegal Possession Of A .40 Caliber "Ghost Gun" Firearm And 10 Rounds Of Ammunition*, DOJ/OPA (Sept. 24, 2021), available at <https://www.justice.gov/usao-md/pr/dc-felon-sentenced-30-months-federal-prison-illegal-possession-40-caliber-ghost-gun>; *Convicted Felon Sentenced for Narcotics Trafficking and Manufacturing "Ghost Guns"*, DOJ/OPA (Sept. 24, 2021), available at <https://www.justice.gov/usao-edva/pr/convicted-felon-sentenced-narcotics-trafficking-and-manufacturing-ghost-guns>; *Two District Men Indicted on Federal Charges Involving Illegal Possession and Sale of Firearms*, DOJ/OPA (Sept. 29, 2021), available at <https://www.justice.gov/usao-dc/pr/two-district-men-indicted-federal-charges-involving-illegal-possession-and-sale-firearms>; *Bronx Man Who Possessed Five "Ghost Guns" Charged With Possessing A Firearm And Ammunition*, DOJ/OPA (Oct. 5, 2021), available at <https://www.justice.gov/usao-sdny/pr/bronx-man-who-possessed-five-ghost-guns-charged-possessing-firearm-and-ammunition>; *Fresno Felon Indicted for Possession of Ammunition*, DOJ/OPA (Oct. 7, 2021), available at <https://www.justice.gov/usao-edca/pr/fresno-felon-indicted-possession-ammunition>; *District Man Sentenced to 10½ Years in Prison for Armed Robbery and Earlier Shooting*, DOJ/OPA (Oct. 13, 2021), available at <https://www.justice.gov/usao-dc/pr/district-man-sentenced-10-years-prison-armed-robbery-and>

Continued

The problem of untraceable firearms being acquired and used by violent criminals and terrorists is international in scope.<sup>21</sup> The NPRM highlighted

earlier-shooting; Brooklyn Felon Sentenced to 48 Months' Imprisonment for Possessing Arsenal of Weapons Including "Ghost Guns", DOJ/OPA (Oct. 12, 2021), available at <https://www.justice.gov/usao-edny/pr/brooklyn-felon-sentenced-48-months-imprisonment-possessing-arsenal-weapons-including>; Syracuse Man Pleads Guilty to Unlawfully Possessing and Selling Firearms and Ammunition, DOJ/OPA (Oct. 15, 2021), available at <https://www.justice.gov/usao-ndny/pr/syracuse-man-pleads-guilty-unlawfully-possessing-and-selling-firearms-and-ammunition>; Two Men Indicted for Firearms Trafficking, DOJ/OPA (Oct. 28, 2021), available at <https://www.justice.gov/usao-edca/pr/two-men-indicted-firearms-trafficking>; Tattoo Shop Owner Sentenced to Prison for Possessing Unlicensed Firearms at his Business, DOJ/OPA (Oct. 28, 2021), available at <https://www.justice.gov/usao-wdpa/pr/tattoo-shop-owner-sentenced-prison-possessing-unlicensed-firearms-his-business>; Mexican National Charged with Possessing Firearms, Methamphetamine in Checked Luggage at MSP Airport, DOJ/OPA (Nov. 2, 2021), available at <https://www.justice.gov/usao-mn/pr/mexican-national-charged-possessing-firearms-methamphetamine-checked-luggage-msp-airport>; Lawrence Man Arrested on Firearms and Narcotics Charges, DOJ/OPA (Nov. 4, 2021), available at <https://www.justice.gov/usao-ma/pr/lawrence-man-arrested-firearms-and-narcotics-charges>; Colchester Man Sentenced to 34 Months in Federal Prison for Illegally Possessing Machinegun, DOJ/OPA (Nov. 12, 2021), available at <https://www.justice.gov/usao-ct/pr/colchester-man-sentenced-34-months-federal-prison-illegally-possessing-machinegun>; Ocean County Man Charged with Illegally Possessing Loaded Semi-Automatic Rifle, DOJ/OPA (Nov. 16, 2021), available at <https://www.justice.gov/usao-nj/pr/ocean-county-man-charged-illegally-possessing-loaded-semi-automatic-rifle>; New Haven Gang Member Charged with Federal Firearm and Narcotics Offenses, DOJ/OPA (Nov. 17, 2021), available at <https://www.justice.gov/usao-ct/pr/new-haven-gang-member-charged-federal-firearm-and-narcotics-offenses>; Edmund H. Mahony, Gang task force accuses two East Hartford men of using 3D printers to manufacture and sell hard-to-track 'ghost guns,' Hartford Courant (Jan. 7, 2022), available at <https://www.courant.com/news/connecticut/hc-news-ghost-gun-arrests-20220107-20220107-hq4agdygxfxdemh7kihaocqxy-story.html> (last visited Mar. 22, 2022).

<sup>21</sup> Firearms using 3D-printed components seized in Sweden, Armament Research Services (May 19, 2017), available at <https://armamentresearch.com/3d-printed-firearms-seized-in-sweden> (last visited Mar. 22, 2022); Lizzie Dearden, Use of 3D printed guns in German synagogue shooting must act as warning to security services, experts say, independent.co.uk (Oct. 11, 2019), available at <https://www.independent.co.uk/news/world/europe/3d-gun-print-germany-synagogue-shooting-stephan-balliet-neo-nazi-a9152746.html> (last visited Mar. 22, 2022); G. Hays, Multiple 3D-printed Firearms Seized in Sydney, Australia, Armament Research Services (Aug. 11, 2020), available at <https://armamentresearch.com/multiple-3d-printed-firearms-seized-in-sydney-australia> (last visited Mar. 22, 2022); Glock ghost guns up for grabs on the dark web, Australian National University (Mar. 23, 2021), available at <https://www.anu.edu.au/news/all-news/glock-ghost-guns-up-for-grabs-on-the-dark-web> (last visited Mar. 22, 2022); Spain dismantles workshop making 3D-printed weapons, BBC (Apr. 19, 2021), available at <https://www.bbc.com/news/world-europe-56798743> (last visited Mar. 22, 2022); Liam Reilly & Alaa Elassar, A Rhode Island man was arrested for

Congress's concern, based on intelligence reports from the Department of Homeland Security ("DHS"), the Federal Bureau of Investigation ("FBI"), and the National Counterterrorism Center ("NCTC"), that untraceable firearms pose a challenge to law enforcement's ability to investigate crimes and that "wide availability of ghost guns and the emergence of functional 3D-printed guns are a homeland security threat."<sup>22</sup> Numerous criminal investigations and studies have also demonstrated these concerns,<sup>23</sup>

allegedly selling 'ghost guns' and trafficking firearms to the Dominican Republic, CNN (Jan. 9, 2022), available at <https://www.cnn.com/2022/01/09/us/rhode-island-ghost-guns-dominican-republic/index.html> (last visited Mar. 22, 2022).

<sup>22</sup> H.R. Rep. No. 116-88, at 2 (2019). The House Report cited a January 11, 2019 Joint Intelligence Bulletin issued by DHS, FBI, and NCTC concluding that "these rapidly evolving technologies pose an ongoing, metastasizing challenge to law enforcement in understanding, tracking, and tracing ghost guns," and an April 22, 2019 DHS intelligence assessment that "repeated the warning that ghost guns pose an urgent and evolving threat to the homeland, particularly in the hands of ideologically motivated lone wolf actors." *Id.*

<sup>23</sup> Paul Ingram, CBP: 3-D-printed full-auto rifle seized at Lukeville crossing, *tucsonsentinel.com* (Feb. 8, 2016), available at [http://www.tucsonsentinel.com/local/report/020816\\_3d\\_printed\\_gun/cbp-3-d-printed-full-auto-rifle-seized-lukeville-crossing](http://www.tucsonsentinel.com/local/report/020816_3d_printed_gun/cbp-3-d-printed-full-auto-rifle-seized-lukeville-crossing) (last visited Mar. 22, 2022); Dark Web Gun Trafficker from Nevada County Pleads Guilty to Unlawful Dealing in Firearms, DOJ/OPA (June 22, 2018), available at <https://www.justice.gov/usao-edca/pr/dark-web-gun-trafficker-nevada-county-pleads-guilty-unlawful-dealing-firearms>; Mahita Gajanan, The TSA Has Found 3D-Printed Guns at Airport Checkpoints 4 Times Since 2016, *Time* (Aug. 2, 2018), available at <https://time.com/5356179/3d-printed-guns-tsa> (last visited Mar. 22, 2022); Grass Valley Man Sentenced to 5 Years in Prison for Unlawfully Manufacturing Ghost Guns and Selling Them on Dark Web, DOJ/OPA (Sept. 21, 2018), available at <https://www.justice.gov/usao-edca/pr/grass-valley-man-sentenced-5-years-prison-unlawfully-manufacturing-ghost-guns-and>; Indiana Residents Indicted on Terrorism and Firearms Charges, DOJ/OPA (July 11, 2019), available at <https://www.justice.gov/opa/pr/indiana-residents-indicted-terrorism-and-firearms-charges>; Fishers residents indicted on terrorism and firearms charges, DOJ/OPA (July 12, 2019), available at <https://www.justice.gov/usao-sdin/pr/fishers-residents-indicted-terrorism-and-firearms-charges>; Brandi Vincent, TSA Confiscated 3D-Printed Guns at Raleigh-Durham International Airport, *nextgov.com* (Mar. 4, 2020), available at <https://www.nextgov.com/emerging-tech/2020/03/tsa-confiscated-3d-printed-guns-raleigh-durham-international-airport/163533> (last visited Mar. 22, 2022); Man Sentenced for Attempting to Board International Flight with a Loaded Firearm, DOJ/OPA (Mar. 12, 2021), available at <https://www.justice.gov/usao-sdca/pr/man-sentenced-attempting-board-international-flight-loaded-firearm>; Lizzie Dearden, Police issue warning over terrorist use of 3D-printed guns as UK neo-Nazi jailed, *MSN News* (June 14, 2021), available at <https://www.msn.com/en-gb/news/uknews/police-issue-warning-over-terrorist-use-of-3d-printed-guns-as-uk-neo-nazi-jailed/ar-AA2G36> (last visited Mar. 22, 2022); Davide Sher, *Oceanian media report seizures of 3D printed guns, submachine guns, 3D Printing Media Network* (June 22, 2021), <https://www.3dprintingmedia.network/oceanian-media->

while several States and municipalities have banned or severely restricted unserialized or 3D-printed firearms.<sup>24</sup>

*report-seizures-of-3d-printed-guns-submachine-guns* (last visited Mar. 22, 2022); DR. Yannick Veilleux-Lepage, CTRL, HATE, PRINT: Terrorists and the appeal of 3D-printed weapons, International Centre for Counter-Terrorism (July 13, 2021), available at <https://icct.nl/publication/ctrl-hate-print-terrorists-and-the-appeal-of-3d-printed-weapons> (last visited Mar. 22, 2022); Chuck Goudie et al., *Al Qaeda launches 1st public campaign in 4 years to encourage lone wolf terrorist attacks*, ABC7 Chicago (July 29, 2021), available at <https://abc7chicago.com/al-qaeda-terrorism-terrorist-attack-inspire-magazine/10918191> (last visited Mar. 22, 2022); Huder Abbasi, *What's behind far-right trend of using 3D tech to make guns?*, *Aljazeera.com* (July 31, 2021), available at <https://www.aljazeera.com/news/2021/7/31/what-behind-far-right-trend-using-3d-tech-make-guns> (last visited Mar. 22, 2022); Fergus Hunter, *Alleged right-wing extremist charged over blueprint to 3D-print a gun*, *The Sydney Morning Herald* (Sept. 13, 2021), available at <https://www.smh.com.au/national/nsw/alleged-right-wing-extremist-arrested-over-blueprint-to-3d-print-a-gun-20210913-p58r80.html> (last visited Mar. 22, 2022); Mexican National Charged with Possessing Firearms, *Methamphetamine in Checked Luggage at MSP Airport*, DOJ/OPA (Nov. 2, 2021), available at <https://www.justice.gov/usao-mn/pr/mexican-national-charged-possessing-firearms-methamphetamine-checked-luggage-msp-airport>.

<sup>24</sup> See Cal. Penal Code. sec. 29180 (prohibiting ownership of firearms that do not bear a serial number or other mark of identification provided by the State); Conn. Gen. Stat. sec. 29-36a(a) (prohibiting manufacture of firearms without permanently affixing serial numbers issued by the State); Del. Code Ann. tit. 11 secs. 1459A, 1462 (prohibiting possession of an unfinished frame or receiver with no serial number and untraceable firearms); DC Code sec. 7-2504.08(a) (prohibiting licensees from selling firearms without serial numbers); Haw. Rev. Stat. sec. 134-10.2 (prohibiting unlicensed persons from producing, purchasing, or possessing 3D-printed or parts kit firearms without a serial number); Mass. Gen. Laws Ch. 269 sec. 11E (prohibiting manufacture or delivery of unserialized firearms to licensed dealer); N.J. Stat. Ann. sec. 2C:39-3(n) (prohibiting possession of firearms manufactured or assembled without serial number); N.Y. Penal Law secs. 265.50, 265.55 (prohibiting manufacture/possession of undetectable firearms); R.I. Gen. Laws sec. 11-47-8(e) (prohibiting possession of "a ghost gun or an undetectable firearm or any firearm produced by a 3D printing process"); Va. Code Ann. sec. 18.2-308.5 (prohibiting possession of undetectable firearms); Wash. Rev. Code sec. 9A.190 (prohibiting the manufacture with intent to sell of undetectable and untraceable firearms); see also *Bill to ban ghost guns passes in Maryland House, heads to Gov. Hogan's desk*, *wjla.com* (Mar. 29, 2022), available at <https://wjla.com/news/local/ghost-guns-ban-bill-passes-maryland-house-maryland-governor-larry-hogan-signs-gun-control> (last visited Apr. 3, 2022); Zenon Evans, *Philadelphia Becomes First City To Ban 3D-Printed Gun Manufacturing*, *Reason.com* (Nov. 22, 2013), available at <https://reason.com/2013/11/22/philadelphia-becomes-first-city-to-ban-3> (last visited Mar. 22, 2022); Council unanimously approves Ghost Guns Bill, restricting the sale [or] transfer of ghost guns to minors, *Montgomerycountymd.gov* (Apr. 6, 2021), available at [https://www2.montgomerycountymd.gov/mcgportalapps/Press\\_Detail.aspx?Item\\_ID=34040&Dept=1](https://www2.montgomerycountymd.gov/mcgportalapps/Press_Detail.aspx?Item_ID=34040&Dept=1) (last visited Mar. 22, 2022); Chris Gros, *Mayor Gloria signs ban on ghost guns in San Diego*, *CBS8* (Sept. 23, 2021), available at <https://www.cbs8.com/article/news/local/mayor-gloria-signs-ban-on-ghost-guns-in-san-diego/509->



Courts have recognized that the information licensees are required to record and maintain under the GCA “enable[s] federal authorities both to enforce the law’s verification measures and to trace firearms used in crimes.” *Abranski v. United States*, 573 U.S. 169, 173 (2014) (citing H.R. Rep. No. 1577, 90th Cong., 2d Sess., 14 (1968)). At least one court has also concluded that ATF has a statutory duty pursuant to the GCA to trace firearms to keep them out of the hands of criminals and other prohibited persons. *Blaustein & Reich, Inc. v. Buckles*, 220 F. Supp. 2d 535, 537 (E.D. Va. 2002). This duty includes assisting State and local law enforcement in their efforts to control the traffic of firearms within their borders.<sup>25</sup> Indeed, as of January 2022, there are approximately 8,674 law enforcement agencies, including 49 agencies from 46 foreign countries, that use eTrace, a web-based application administered by ATF that allows authorized law enforcement agencies to submit and conduct comprehensive traces of recovered crime guns and develop long-term strategies on how best to reduce firearms-related crime, firearms trafficking, and violence in their communities.<sup>26</sup>

As discussed in the NPRM, tracing is an integral tool for Federal, State, local, and international law enforcement agencies to utilize in their criminal investigations, and the proliferation of untraceable firearms severely

undermines this process. 86 FR at 27724–25. The NPRM described the overall process that ATF engages in when tracing firearms submitted by law enforcement. *Id.* at 27724. The Department stressed how ATF relies on the recordkeeping required to be maintained by licensees in order to locate the first unlicensed person who acquired the recovered firearm from a licensed dealer.<sup>27</sup> This information can help find the perpetrator or provide valuable leads that help to solve the crime. Thus, for a successful trace to be conducted, an accurate firearm description is necessary and required to be recorded by a person licensed to engage in the business of manufacturing, importing, or dealing in firearms, or by a licensed collector of curio or relic firearms, regardless of whether it is a business or personal firearm of the licensee.<sup>28</sup>

Because PMFs lack serial numbers and other markings from a licensed manufacturer, ATF has found it extremely difficult to successfully complete traces of PMFs. Out of the approximately 45,240 submitted traces of suspected PMFs mentioned above, ATF could only successfully complete approximately 445 of those attempted traces to an individual unlicensed purchaser.<sup>29</sup> Successful traces of PMFs have been completed in these rare instances primarily because licensees who acquired PMFs sometimes recorded a serial number that had been voluntarily engraved by the manufacturer on a commercially produced handgun slide, barrel, or

another firearm part, which are not required by the GCA to be marked.

In the NPRM, the Department noted that, with the rapid emergence of PMFs in recent years, licensees have sought clarity from ATF on how PMFs may be accepted and recorded. 86 FR at 27724–25. Licensees engaged in the business of dealing in firearms are subject to various recording and reporting requirements, including completion of a Firearms Acquisition and Disposition Record (“A&D Record”) to record their firearms inventory,<sup>30</sup> a Firearms Transaction Record, ATF Form 4473 (“Form 4473”), for disposition of a firearm to an unlicensed person,<sup>31</sup> a Federal Firearms Licensee Theft/Loss Report, ATF Form 3310.11, upon discovery of the theft or loss of firearms,<sup>32</sup> and a Report of Multiple Sale or Other Disposition of Pistols and Revolvers, ATF Form 3310.4, to document sales or other dispositions of multiple pistols or revolvers within five consecutive business days to the same person.<sup>33</sup> These forms require licensees to record the manufacturer and importer (if any), model (if designated), serial number, type, and caliber or gauge of the firearm.

As applied to PMFs, licensees acquiring them might only record a “type” of firearm (e.g., pistol, revolver, rifle, or shotgun) in their A&D records and on Forms 4473. With such limited information, it will become increasingly difficult, if not impossible, for licensees and ATF (during inspections) to match accurately and reliably the PMFs in the firearms inventory with those recorded in required A&D records, or to determine whether the PMFs recorded as disposed on Forms 4473 are those recorded as disposed in the A&D records.<sup>34</sup> Likewise, licensees and ATF

ddd5f49d-29dc-42a6-8f2c-41f17381718f (last visited Mar. 22, 2022); Julia Wick, L.A. City Council votes to ban ‘ghost guns’, *Police1.com* (Dec. 1, 2021), available at <https://www.police1.com/gun-legislation-law-enforcement/articles/la-city-council-votes-to-ban-ghost-guns-8f2c-41f17381718f> (last visited Mar. 22, 2022); Hannah Metzger, *Denver outlaws owning, manufacturing ‘ghost guns’ in city*, *denvergazette.com* (Jan. 3, 2022), available at [https://denvergazette.com/news/government/denver-outlaws-owning-manufacturing-ghost-guns-in-city/article\\_88799392-6d04-11ec-9da0-134e7e7be5f2.html](https://denvergazette.com/news/government/denver-outlaws-owning-manufacturing-ghost-guns-in-city/article_88799392-6d04-11ec-9da0-134e7e7be5f2.html) (last visited Mar. 22, 2022); Jakob Rodgers, *Oakland joins growing list of California cities to ban ghost guns*, *mercurynews.com* (Jan. 18, 2022), available at <https://www.mercurynews.com/2022/01/18/oakland-joins-growing-list-of-california-cities-to-ban-ghost-guns> (last visited Mar. 22, 2022).

<sup>25</sup> See Public Law 90–351, sec. 901(a), 82 Stat. 212, 225–26 (1968); 18 U.S.C. 922(b)(2) (prohibiting licensees from selling or delivering any firearm to any person in a State where the purchase or possession by such person of such firearm would be in violation of any State law or published ordinance applicable at the place of sale, delivery, or other disposition); 18 U.S.C. 922(t)(2), (4) (NICS background check denied if receipt of firearm by transferee would violate State law); 18 U.S.C. 923(d)(1)(F) (requiring license applicants to certify compliance with the requirements of State and local law applicable to the conduct of business).

<sup>26</sup> Fact Sheet, eTrace: Internet-Based Firearms Tracing and Analysis, ATF (Sept. 2021), available at <https://www.atf.gov/resource-center/fact-sheet/fact-sheet-etrace-internet-based-firearms-tracing-and-analysis>.

<sup>27</sup> Licensees must respond to ATF trace requests within 24 hours. 18 U.S.C. 923(g)(7); see also *J&G Sales Ltd. v. Truscott*, 473 F.3d 1043, 1045–46 (9th Cir. 2007) (describing the tracing process).

<sup>28</sup> See 18 U.S.C. 923(c); 27 CFR 478.125a(a)(4) (licensed manufacturers, importers, and dealers must record in a bound volume a complete description of firearms disposed of from their personal collections); 18 U.S.C. 923(g)(1)(A), (D); 27 CFR 478.125(e), (f) (licensed dealer and collector disposition records must contain a complete description of the firearm); 132 Cong. Rec. 15229 (1986) (Statement of Rep. Hughes) (“In order for the law enforcement Firearm Tracing Program to operate, some minimal level of recordkeeping is required [for sales from dealers’ personal collections]. Otherwise, we will not have tracing capability. This provision simply requires that a bound volume be maintained by the dealer of the sales of firearms which would include a complete description of the firearm, including its manufacturer, model number, and its serial number and the verified name, address, and date of birth of the purchaser. This is only a minimal inconvenience for the dealer, yet obtaining and recording this information is critical to avoid serious damage to the Firearm Tracing Program.”).

<sup>29</sup> Source: ATF Office of Strategic Intelligence and Information. These numbers (as of January 21, 2022) include traces for both U.S. and international law enforcement agencies.

<sup>30</sup> 27 CFR 478.125(e).

<sup>31</sup> 18 U.S.C. 923(g)(1)(A); 27 CFR 478.124.

<sup>32</sup> 18 U.S.C. 923(g)(6); 27 CFR 478.39a(b).

<sup>33</sup> 18 U.S.C. 923(g)(3)(A); 27 CFR 478.126a.

Pursuant to 18 U.S.C. 923(g)(5)(A), licensed dealers along the Southwest U.S. border are also required by demand letter to report to ATF multiple sales of certain rifles during five consecutive business days to the same person on ATF Form 3310.12, including the rifle’s serial number, manufacturer, importer, model, and caliber. Also under that statute, licensed dealers with 25 or more trace requests with a “time-to-crime” of three years or less must report to ATF the acquisition date, model, caliber or gauge, and the serial number of a secondhand firearm transferred by the dealer.

<sup>34</sup> In *United States v. Biswell*, 406 U.S. 311, 315–16 (1972), the Supreme Court explained that “close scrutiny of [firearms] traffic is undeniably of central importance to federal efforts to prevent violent crime and to assist the States in regulating the firearms traffic within their borders. Large interests are at stake, and inspection is a crucial part of the regulatory scheme, since it assures that weapons are distributed through regular channels and in a traceable manner and makes possible the prevention of sales to undesirable customers and

will have difficulty accurately determining which PMFs were stolen or lost from inventory. It will also be difficult for police to locate stolen PMFs in the business inventories of pawnbrokers, for example,<sup>35</sup> or to return any recovered stolen or lost PMFs to their rightful owners.

Assuming a PMF can be successfully traced to a Federal firearms licensee (“FFL”) or that a correct Form 4473 can be located, the NPRM explained that the ATF Form 4473 is the primary evidence used to prosecute straw purchasers who buy firearms from FFLs typically on behalf of prohibited persons, such as felons or illegal firearms traffickers, and other persons who could use the firearms to commit violent crimes.<sup>36</sup> The form is typically the key evidence that the straw purchaser who bought the firearm (and who can pass a background check) made a false statement to the FFL concerning the identity of the actual purchaser when acquiring that firearm, in violation of 18 U.S.C. 922(a)(6) and 924(a)(1)(A), or State law.<sup>37</sup> But as

the detection of the origin of particular firearms” (citation omitted).

<sup>35</sup> Most states require pawnbrokers to record or report any serial number and other identifying markings on pawned merchandise so that police can determine their origin. See Ala. Code sec. 5–19A–3(1); Alaska Stat. sec. 08.76.180(a)(4); Ariz. Rev. Stat. sec. 44–1625(C)(5); Colo. Rev. Stat. sec. 29–11.9–103(1); Conn. Gen. Stat. sec. 21–41(c); Del. Code Ann. tit. 24, sec. 2302(a)(1)(b); D.C. Code sec. 47–2884.11(d); Fla. Stat. sec. 538.04(1)(b)(3), (9); Ga. Code sec. 44–12–132(4); Haw. Rev. Stat. sec. 445–134.11(c)(10); 205 Ill. Comp. Stat. 510/5(a); Ind. Code sec. 28–7–5–19(a)(4); Ky. Rev. Stat. Ann. Sec. 226.040(1)(d)(7); La. Stat. Ann. sec. 37:1782(16)(a); Mass. Gen. Laws ch. 140 sec. 79; Mich. Comp. Laws sec. 446.205(5)(1), (4); Minn. Stat. sec. 325J.04(Sub.1)(1); Miss. Code Ann. sec. 75–67–305(1)(a)(iii), (ix); Mo. Rev. Stat. sec. 367.040(4)(6)(b); Neb. Rev. Stat. sec. 69–204(3); N.M. Stat. Ann. sec. 56–12–9(A)(3); N.C. Gen. Stat. sec. 66–391(b)(1); Ohio Rev. Code Ann. sec. 4727.07; Okla. Stat. tit. 59 sec. 1509(D)(h); S.C. Code Ann. sec. 40–39–80(B)(1)(i)(iii), (ix); Tenn. Code Ann. sec. 45–6–209(b)(1)(C), (H); Tex. Fin. Code Ann. sec. 371.157(4); Utah Code Ann. sec. 13–32a–104(1)(h)(i)(A); Va. Code Ann. sec. 54.1–4009(A)(1); Wash. Rev. Code sec. 19.60.020(1)(e); W. Va. Code sec. 47–26–2(b)(1); Wis. Stat. sec. 134.71(8)(c)(2).

<sup>36</sup> See *United States v. Marzarella*, 614 F.3d 85, 100 (3d Cir. 2010) (“The direct tracing of the chain of custody of firearms involved in crimes is one useful means by which serial numbers assist law enforcement. But serial number tracing also provides agencies with vital criminology statistics—including a detailed picture of the geographical source areas for firearms trafficking and “time-to-crime” statistics which measure the time between a firearm’s initial retail sale and its recovery in a crime—as well as allowing for the identification of individual dealers involved in the trafficking of firearms and the matching of ballistics data with recovered firearms” (footnotes omitted).); *Following the Gun: Enforcing Federal Laws Against Firearms Traffickers*, ATF at 1, 26 (2000) (serial number obliteration is a clear indicator of firearms trafficking to, among other criminals, armed narcotics traffickers).

<sup>37</sup> See, e.g., *Abramski v. United States*, 573 U.S. 169, 192 (2014); *Marshall v. Virginia*, 822 SE2d 389,

unmarked and difficult-to-trace PMFs are transacted throughout the commercial marketplace, law enforcement will have difficulties prosecuting straw purchasers for making false statements because it will be harder to prove that the firearms acquired under false pretenses on a Form 4473 were the ones found in the hands of the true purchaser.<sup>38</sup> Likewise, the absence of identifying firearm information on multiple sales forms and theft/loss reports makes it more difficult for ATF to identify firearms traffickers and thieves.<sup>39</sup>

#### C. Advanced Notice of Proposed Rulemaking on Identification Markings Placed on Firearm Silencers and Firearm Mufflers

The NPRM noted that on May 4, 2016, the Department published an advance notice of proposed rulemaking (“ANPRM”) in the **Federal Register**. 86 FR 27728 n.50 (citing 81 FR 26764). The ANPRM was issued in response to a petition filed on behalf of the National Firearms Act Trade and Collectors Association (“NFATCA”), a trade group representing the firearms and import community. The petitioner requested that the relevant regulations be amended to require that a silencer be marked on the outer tube as opposed to other locations, such as an end cap that might be damaged when a projectile passes through it, unless a variance is granted by the Director on a case-by-case basis for good cause. ATF found that the petitioner raised valid concerns.

Under the GCA, licensed manufacturers and importers must

392–93 (Va. Ct. App. 2019); *Shirley v. Glass*, 297 Kan. 888 (2013); *Pennsylvania v. Baxter*, 956 A.2d 465, 472 (Pa. Super. Ct. 2008).

<sup>38</sup> See, e.g., *United States v. Powell*, 467 F. Supp. 3d 360, 368, 374 (E.D. Va. 2020) (indictment charging false statements on ATF Form 4473 in connection with the purchase of specific handguns listed by date of purchase, make, caliber, model, serial number, and name of FFL); *United States v. McCurdy*, 634 F. Supp. 2d 118, 121–22, 126 (D. Me. 2009) (denial of a motion for a new trial discussing whether the firearm sold as documented on the ATF Form 4473 and the firearm introduced at trial were the same).

<sup>39</sup> The lack of firearm description information in theft/loss reports makes it difficult for ATF to match recovered firearms with those reported as lost or stolen, thereby hindering ATF’s efforts to enforce the numerous provisions of the GCA that prohibit thefts. See 18 U.S.C. 922(i) (transporting or shipping stolen firearms in interstate or foreign commerce); 18 U.S.C. 922(j) (receiving, possessing, concealing, storing, bartering, selling, disposing, or pledging or accepting as security for a loan any stolen firearm which has moved in interstate or foreign commerce); 18 U.S.C. 922(u) (stealing a firearm that has been shipped or transported in interstate or foreign commerce from the person or premises of an FFL); 18 U.S.C. 924(j) (stealing a firearm which is moving in or has moved in interstate commerce); 18 U.S.C. 924(m) (stealing a firearm from a licensee).

identify the frame or receiver of each firearm, including a firearm muffler or silencer, with a serial number in accordance with regulations. 18 U.S.C. 921(a)(3)(C), 923(i). The NFA requires firearm manufacturers, importers, and makers to identify each firearm, including a firearm muffler or silencer, with a serial number and such other identification as may be prescribed by regulations. 26 U.S.C. 5842(a), 5845(a)(7). Because the NFA defines each individual part of a firearm muffler or silencer as a “firearm”<sup>40</sup> that must be registered in the NFRTR, the regulations currently assume that every part defined as a silencer must be marked in order to be registered, and expressly require that each part be marked whenever sold, shipped, or otherwise disposed of even though it may have been installed by a qualified licensee within a complete muffler or silencer device.<sup>41</sup>

The ANPRM explained that, along with industry members, ATF considers the term “outer tube” to mean the largest external part of a silencer and is that portion of a silencer that encapsulates all components of the silencing unit, and which contains and controls the expansion of the escaping gases. 81 FR at 26765. ATF explained that placing all required markings on the outer tube of a completed firearm silencer or firearm muffler is the accepted industry standard. In addition, ATF discussed that requiring identification markings to be placed on a single part provides consistency of markings throughout the industry and eliminates the need to re-mark a device in the event an end cap bearing the markings is damaged and requires replacement. ATF believed that a more specific marking requirement for firearm silencers, such as the outer tube, would lead to greater uniformity, improve public safety, and decrease firearms crimes, including firearms trafficking. See *id.*

The ANPRM was used to solicit comments to determine if an amendment to the regulations that would require placement of

<sup>40</sup> A firearm “muffler or silencer” is defined to include “any combination of parts” designed and intended for the use in assembling or fabricating a firearm silencer or muffler and “any part intended only for use in such assembly or fabrication.” 18 U.S.C. 921(a)(24); 26 U.S.C. 5845(a)(7); 27 CFR 478.11, 479.11. This rule defines the term “complete muffler or silencer device” not to exempt individual silencer parts from the definition of firearm “muffler or silencer” subject to the requirements of the NFA, but to advise industry members when those individual silencer parts must be marked and registered in the NFRTR when they are used in assembling, fabricating, or repairing a muffler or silencer device.

<sup>41</sup> See 27 CFR 479.101(b), 478.92(a)(4)(iii), 479.102(f)(1).

identification markings on the outer tube of firearm silencers and mufflers was warranted. In response to the ANPRM, ATF received 48 comments. A few commenters supported issuance of a proposed rule because they believed it would not violate any constitutional rights under the Second Amendment, would enhance public safety for the reasons ATF stated, and would reduce confusion within the industry without being a financial burden because it is already a standard practice with many manufacturers. The majority of commenters expressed opposition and did not want ATF to proceed with any further rulemaking. Specific reasons for their objection to a proposed rule included a belief that: (1) ATF lacks legal authority to specify where markings on silencers must be located and that such a rule would violate the Second Amendment; (2) the initial NFATCA petition is outdated; (3) there is no data to support that a new rule would enhance public safety or reduce firearms trafficking; (4) a new regulation is unnecessary as the industry is already complying; (5) it is not feasible to comply with marking on the outer tube of the silencer with specific designs; (6) the proposed idea hinders technological advances and future designs; (7) it would create confusion and definitional problems because the definition of outer tube is outdated; and (8) the industry and public would incur financial burdens.

Other commenters offered suggestions about outer tube replacement options especially because silencer tubes wear out over time. They suggested that a rule would be reasonable if ATF authorizes manufacturers to repair or replace damaged silencer tubes and engrave the new tube with the original serial number. Commenters also suggested alternative locations for silencer markings such as on end caps. They believed that markings should be placed on the major portion of the silencer, which could be the end cap or any section of the tube. They stressed that the outer tube is thin and there is a greater risk of burning through the metal when engraving and that end caps have greater thickness to work with when engraving.

Based on further review and the comments received in response to the ANPRM, ATF incorporated a proposed definition of “frame or receiver” as it applies to firearm mufflers and silencers in the NPRM to clarify when and how silencer parts are to be marked and registered. 86 FR 27720.

### III. Notice of Proposed Rulemaking

On May 21, 2021, the Department published in the **Federal Register** an NPRM entitled “Definition of ‘Frame or Receiver’ and Identification of Firearms,” 86 FR 27720, proposing changes to various regulations in 27 CFR parts 447, 478, and 479. Overall, the NPRM proposed amending ATF’s regulations to clarify the definition of “firearm” and to provide a more comprehensive definition of “frame or receiver” so that these terms more accurately reflect how most modern-day firearms are produced and function, and so that the courts, the firearms industry, and the public at large would no longer misinterpret the term to mean that most firearms in circulation have no parts identifiable as a frame or receiver. The NPRM also proposed new terms and definitions to account for technological developments and modern terminology in the firearms industry, as well as proposed amendments to the marking and recordkeeping requirements that would be necessary to implement these definitions.

#### A. Definition of “Firearm”

In the NPRM, the Department proposed adding a sentence at the end of the definition of “firearm” in 27 CFR 478.11 to reflect existing case law, providing that “[t]he term shall include a weapon parts kit that is designed to or may readily be assembled, completed, converted, or restored to expel a projectile by the action of an explosive.” However, the proposed amendment was not intended to affect the classification of a weapon, including a weapon parts kit, in which the frame or receiver (as defined in the proposed rule) of such weapon is properly destroyed. *See* 86 FR at 27726, 27729–30. Therefore, another sentence was proposed to be added at the end of the definition of “firearm” to provide that “[t]he term shall not include a weapon, including a weapon parts kit, in which each part defined as a frame or receiver of such weapon is destroyed.” *Id.* at 27726.

The Department explained in the NPRM that “firearm” as defined under the GCA, 18 U.S.C. 921(a)(3) and 27 CFR 478.11, includes inoperable weapons even though they will not expel a projectile by the action of an explosive at the time of sale or distribution if they are “designed to”<sup>42</sup> or “may readily be

converted”<sup>43</sup> to expel a projectile by the

designed to expel a projectile by the action of an explosive); *United States v. Dotson*, 712 F.3d 369, 370–71 (7th Cir. 2013) (saying, in ruling that a pistol with corroded, missing, and broken components was a “firearm,” that “[a]n airplane is designed to fly; a defect in manufacture or maintenance that prevents it from flying does not alter its design”); *United States v. Davis*, 668 F.3d 576, 577 (8th Cir. 2012) (holding that a pistol with no trigger was a “firearm” within the meaning of section 2K2.1(a)(3)(A)(i) of the Sentencing Guidelines and applying “the same reasoning [that courts have applied in section 921(a)(3) cases] to Guidelines provisions that incorporate the § 921(a)(3) definition”); *United States v. Counce*, 445 F.3d 1016, 1018 (8th Cir. 2006) (handgun with missing safety); *United States v. Rivera*, 415 F.3d 284, 285–87 (2d Cir. 2005) (pistol with a broken firing pin and flattened firing-pin channel); *United States v. Morales*, 280 F. Supp. 2d 262, 272–73 (S.D.N.Y. 2003) (partially disassembled Tec-9 pistol was designed to expel a projectile); *United States v. Adams*, 137 F.3d 1298, 1300 & n.2 (11th Cir. 1998) (potentially inoperable shotgun); *United States v. Brown*, 117 F.3d 353 (7th Cir. 1997) (holding that a gun with no firing pin was a “firearm” within the meaning of section 2B3.1(b)(2)(C) of the Sentencing Guidelines, and discussing analogous cases interpreting section 921(a)(3)(A)); *United States v. Reed*, 114 F.3d 1053 (10th Cir. 1997) (shotgun with broken breech bolt); *United States v. Hunter*, 101 F.3d 82 (9th Cir. 1996) (holding that the sentence enhancement for use of a semiautomatic weapon in section 924(c) applied to a pistol with broken firing pin); *United States v. Yannott*, 42 F.3d 999, 1005–07 (6th Cir. 1994) (shotgun with broken firing pin); *United States v. Ruiz*, 986 F.2d 905, 910 (5th Cir. 1993) (revolver with hammer filed down); *United States v. York*, 830 F.2d 885, 891 (8th Cir. 1987) (revolver with no firing pin and cylinder did not line up with barrel); *United States v. Thomas*, No. 17–194 (RDM), 2019 WL 4095569, at \*4 (D.D.C. Aug. 29, 2019) (in ruling that a revolver missing its hammer, hammer screw, trigger, cylinder stop, hand, ejector rod housing, base pin, screw, nut, spring, loading gate detent and spring and miscellaneous screws was a “firearm,” the court said: “[t]he Titanic was, after all, ‘designed’ to be unsinkable”). *But see Dotson*, 712 F.3d at 371 (a Beretta pistol redesigned to be a cigarette lighter); *Rivera*, 415 F.3d at 286–87 (“[A] gun with a barrel filled with lead, maybe for use as a theatrical prop, might perhaps no longer be deemed ‘designed to’ or ‘readily be converted’ to fire a bullet.”); *United States v. Wada*, 323 F. Supp. 2d 1079 (D. Or. 2004) (firearms redesigned as ornaments that “would take a great deal of time, expertise, equipment, and materials to attempt to reactivate” were no longer designed to expel a projectile by the action of an explosive, and could not readily be converted to do so).

<sup>43</sup> *See, e.g., United States v. Mullins*, 446 F.3d 750, 756 (8th Cir. 2006) (starter gun that can be modified in less than one hour by a person without any specialized knowledge to fire may be considered “readily convertible” under the GCA); *United States v. 16,179 Molso Italian .22 Caliber Winlee Derringer Convertible Starter Guns*, 443 F.2d 463 (2d Cir. 1971) (starter guns converted in no more than 12 minutes to fire live ammunition were readily convertible under the GCA); *United States v. Morales*, 280 F. Supp. 2d 262, 272–73 (S.D.N.Y. 2003) (partially disassembled Tec-9 pistol that could be assembled within a short period of time could readily be converted to expel a projectile). *Cf. United States v. Dodson*, 519 F. App’x 344, 352–53 (6th Cir. 2013) (gun that was restored with 90 minutes of work, using widely available parts and equipment and common welding techniques, fit comfortably within the readily restorable standard of 26 U.S.C. 5845(b)); *United States v. TRW Rifle 7.62x51mm Caliber, One Model 14 Serial 593006*,

Continued

<sup>42</sup> Numerous courts have held that weapons designed to expel a projectile by the action of an explosive are “firearms” under 18 U.S.C. 921(a)(3)(A) even if they cannot expel a projectile in their present form or configuration. *See, e.g., United States v. Hardin*, 889 F.3d 945, 946–47, 949 (8th Cir. 2018) (pistol with broken trigger and numerous missing internal parts was a weapon

action of an explosive. Weapon parts kits, or aggregations of weapon parts, some of which contain all of the components necessary to complete a functional weapon within a short period of time, have been increasingly sold to individuals either directly from manufacturers of the kits or retailers, without background checks or recordkeeping. 86 FR at 27726. Some of these firearm kits include jigs, templates, and tools that allow the purchaser to complete the weapon fairly or reasonably efficiently, quickly, and easily to a functional state. Such weapon parts kits or aggregations of weapon parts that are *designed to or may readily be converted to expel a projectile* by the action of an explosive are also “firearms” under 18 U.S.C. 921(a)(3)(A).<sup>44</sup> This proposed addition

447 F.3d 686, 692 (9th Cir. 2006) (a two-hour restoration process using ordinary tools, including a stick weld, is within the ordinary meaning of “readily restored”); *United States v. One TRW, Model M14, 7.62 Caliber Rifle*, 441 F.3d 416, 422–24 (6th Cir. 2006) (“[T]he Defendant weapon here had all of the necessary parts for restoration and would take no more than six hours to restore.”); *United States v. Woods*, 560 F.2d 660, 664 (5th Cir. 1977) (holding that a weapon was a shotgun within the meaning of 26 U.S.C. 5845(d) and stating “[t]he fact that the weapon was in two pieces when found is immaterial considering that only a minimum of effort was required to make it operable.”); *United States v. Smith*, 477 F.2d 399, 400–01 (8th Cir. 1973) (machinegun that would take around an eight-hour working day in a properly equipped machine shop was readily restored to shoot); *United States v. Catanzaro*, 368 F. Supp. 450, 453 (D. Conn. 1973) (a sawed-off shotgun was “readily restorable to fire” where it could be reassembled in one hour and the necessary missing parts could be obtained at a Smith & Wesson plant). *But see United States v. Seven Miscellaneous Firearms*, 503 F. Supp. 565, 574–75 (D.D.C. 1980) (weapons could not be “readily restored to fire” when restoration required master gunsmith in a gun shop and \$65,000 worth of equipment and tools).

<sup>44</sup> See, e.g., *United States v. Wick*, 697 F. App'x 507, 508 (9th Cir. 2017) (complete UZI parts kits “could ‘readily be converted to expel a projectile by the action of an explosive,’ meeting the statute’s definition of firearm under § 921(a)(3)(A)” because the “kits contained all of the necessary components to assemble a fully functioning firearm with relative ease”); *United States v. Stewart*, 451 F.3d 1071, 1072–73, 1073 n.2 (9th Cir. 2006) (upholding district court’s finding that .50 caliber rifle kits with incomplete receivers were “firearms” under section 921(a)(3)(A) because they could easily be converted to expel a projectile); *United States v. Theodoropoulos*, 866 F.2d 587, 595 n.3 (3d Cir. 1989), *overruled in part on other grounds by United States v. Price*, 76 F.3d 526, 528 (3d Cir. 1996) (disassembled machine pistol that that could easily be made operable was a firearm under section 921(a)(3)(A)); *United States v. Morales*, 280 F. Supp. 2d 262, 272–73 (S.D.N.Y. 2003) (partially disassembled Tec-9 pistol that could be assembled within short period of time could readily be converted to expel a projectile was a firearm under section 921(a)(3)(A)); *United States v. Randolph*, No. 02 CR. 850–01 (RWS), 2003 WL 1461610, at \*2 (S.D.N.Y. Mar. 20, 2003) (gun consisting of “disassembled parts with no ammunition, no magazine, and a broken firing pin, making it incapable of being fired without replacement or repair” was a “firearm” under section 921(a)(3)(A)

makes explicit that manufacturers and sellers of such kits or aggregations of weapon parts are subject to the same regulatory requirements applicable to the manufacture or sale of fully completed and assembled firearms. See 86 FR at 27726.

#### B. Definition of “Frame or Receiver”

The Department proposed to revise the definition of “frame or receiver” with a multi-part definition. First proposed was a general definition of “frame or receiver” with nonexclusive examples that illustrated the definition. This was followed by four proposed supplements, described below, that further explained the meaning of the term “frame or receiver” for certain firearm designs and configurations. Although the proposed definition was intended to more broadly define the term “frame or receiver” than the current definition, it was not intended to alter any prior determinations by ATF regarding which specific part of a given weapon it considered the frame or receiver. The NPRM also proposed to codify in the regulations the factors ATF considers when classifying the frame or receiver of a firearm.

#### 1. General Definition of “Frame or Receiver”

As a threshold matter, the NPRM proposed that the new definition, with a partial exception for an internal frame or chassis, make clear that each frame or receiver be visible to the exterior when the complete weapon is assembled so that licensees and law enforcement can quickly and easily identify the markings. Next, the NPRM proposed defining the term “frame or receiver” more broadly as a part that provides housing or a structure designed to hold or integrate any fire control component, which would have included, at a minimum, any housing or holding structure for a hammer, bolt, bolt carrier, breechblock, cylinder, trigger mechanism, firing pin, striker, or slide rails. However, the proposed definition would not have been limited to those particular fire control components<sup>45</sup>

because it could be readily converted to expel a projectile and included the frame or receiver of such a weapon); *cf. United States v. Annis*, 446 F.3d 852, 857 (8th Cir. 2006) (partially disassembled rifle that could easily be made operational was a firearm under sentencing guidelines); *United States v. Ryles*, 988 F.2d 13, 16 (5th Cir. 1993) (same with disassembled shotgun that could have been readily converted to an operable firearm); *Enamorado v. United States*, No. C16–3029–MWB, 2017 WL 2588428, at \*6 (N.D. Iowa June 14, 2017) (same with disassembled .45 caliber handgun that could easily be reassembled).

<sup>45</sup> The prefatory paragraph to the definitional sections in the GCA and NFA regulations explain that “[t]he terms ‘includes’ and ‘including’ do not

and was proposed to be general enough to encompass changes in technology and parts terminology. For further clarity, four nonexclusive examples with illustrations of common single-framed firearms were provided. See 86 FR at 27727, 27742. Finally, the proposed definition stated that persons who may acquire or possess a part now defined as a frame or receiver that is identified with a serial number must presume, absent an official determination by ATF or other reliable evidence to the contrary, that the part is a firearm frame or receiver without further guidance.

#### 2. Definition of “Firearm Muffler or Silencer Frame or Receiver”

The first proposed supplement to define the term “frame or receiver” as it applies to a “firearm muffler or silencer frame or receiver” and to add a new term “complete muffler or silencer device” is further discussed in Section III.D of this preamble. The NPRM proposed that in the case of a firearm muffler or firearm silencer, the frame or receiver is a part of the firearm that is visible from the exterior of a completed device and provides a housing or a structure designed to hold or integrate one or more essential internal components of the device.

As described in Section II.C of this preamble, the GCA’s marking requirement and the GCA/NFA’s definition of firearm “muffler or silencer” (sometimes referred to as a “sound suppressor”) and its marking requirements have caused confusion and concern among many silencer manufacturers over the years. The NPRM explained that some silencer parts defined as “silencers,” such as baffles, are difficult for manufacturers to mark and listed examples of the ATF forms that manufacturers would have difficulty filing and processing in a timely manner. 86 FR at 27728. The Department also explained that it makes little sense to mark all silencer parts for tracing purposes when the outer tube or housing of the complete device is marked and registered. *Id.* at 27727–28.

For these reasons, the new definitions were proposed to clarify for manufacturers and makers of complete muffler or silencer devices that they need only mark the one part of the device defined as the frame or receiver under the proposed rule. However, individual muffler or silencer parts were proposed to be marked if they are disposed of separately from a complete

exclude other things not enumerated which are in the same general class or are otherwise within the scope thereof.” 27 CFR 478.11, 479.11.

device unless transferred by manufacturers qualified under the NFA to other qualified licensees for the manufacture or repair of complete devices.<sup>46</sup>

### 3. Definition of “Split or Modular Frame or Receiver”

The second proposed supplement to the general definition sought to capture the majority of firearms that now use a split design as discussed above. It sought to clarify that even though a firearm, including a silencer, may have more than one part that falls within the definition of “frame or receiver,” ATF may classify a specific part or parts to be the “frame or receiver” of a particular weapon. It then set forth the various factors ATF would consider in making this determination with no single factor controlling. *See* 86 FR at 27728–29, 27743. It also proposed the clarification that “[f]rames or receivers of different weapons that are combined to create a similar weapon each retain their respective classifications as frames or receivers provided they retain their original design and configuration.” *Id.* at 27734.

To ensure that the proposed definition of “split or modular frame or receiver” did not affect existing ATF classifications that specified a single component as the frame or receiver, the definition included a nonexclusive list of common weapons with a split or modular frame or receiver configuration for which ATF previously determined a specific part to be the frame or receiver. *See id.* at 27729, 27743–46. The NPRM explained that a manufacturer or importer of one of these firearm designs, as they would exist as of the final rule’s date of publication, could refer to this list to know which part is the frame or receiver, thereby allowing the manufacturer or importer to mark a single part without seeking a determination from ATF. However, if there was to be a present or future split or modular design for a firearm that was not comparable to an existing classification, then the proposed definition of “frame or receiver” would advise, absent a variance or classification from ATF, that more than one part is the frame or receiver subject to marking and other requirements.

### 4. Definition of “Partially Complete, Disassembled, or Inoperable Frame or Receiver”

The third supplement proposed to define “frame or receiver” as including frames or receivers that are partially

complete, disassembled, or inoperable, or a frame or receiver that has reached a stage in manufacture where it may readily be completed, assembled, converted, or restored to a functional state. The NPRM stated that, to determine this status, “the Director may consider any available instructions, guides, templates, jigs, equipment, tools, or marketing materials.” 86 FR at 27729, 27746. “Partially complete,” for purposes of this definition, was proposed to mean a forging, casting, printing, extrusion, machined body, or similar article at a stage in manufacture where it is clearly identifiable as an unfinished component part of a weapon.

The NPRM explained that this supplemental definition aimed to address when an object becomes a frame or receiver such that it is a regulated article. The NPRM stated that partially complete or unassembled frames or receivers, commonly called “80% receivers,”<sup>47</sup> are often sold in kits where the frame or receiver can readily be completed or assembled to a functional state. *See id.* at 27729 n.54. The Department stated that the supplemental definition is necessary for clarity because companies are not running background checks or maintaining transaction records when they manufacture and sell these kits. Accordingly, prohibited persons have easily obtained them<sup>48</sup> and, when recovered, they are nearly impossible to trace. The proposed definition also

<sup>47</sup> The term “80% receiver” is a term used by some industry members, the public, and the media to describe a frame or receiver that has not yet reached a stage of manufacture to be classified as a “frame or receiver” under Federal law. However, that term is neither found in Federal law nor accepted by ATF.

<sup>48</sup> *See* 86 FR at 27729 n.55; *see also* Gene Johnson, *Felon on supervision accused of having ‘ghost gun’ arsenal*, Associated Press (Feb. 28, 2020), available at <https://apnews.com/article/cc61d48e83a2c8113c8b1e1ed6fe6006> (last visited Mar. 23, 2022); Sarah Cassi, *Lehigh Valley felon was using 3D printer to make ‘ghost guns’ at home, Pa. attorney general says*, *LehighValleyLive.com* (June 29, 2021), available at <https://www.lehighvalleylive.com/northampton-county/2021/06/lehigh-valley-felon-was-using-3d-printer-to-make-ghost-guns-at-home-pa-attorney-general-says.html> (last visited Mar. 23, 2022); *Deputy recovers ‘ghost gun’ from convicted felon during traffic stop*, *Fontana Herald News* (Aug. 10, 2021), available at [https://www.fontanaheraldnews.com/news/inland-empire\\_news/deputy-recovers-ghost-gun-from-convicted-felon-during-traffic-stop/article\\_3cfe0fd0-f4a3-11eb-bd31-03979dc83307.html](https://www.fontanaheraldnews.com/news/inland-empire_news/deputy-recovers-ghost-gun-from-convicted-felon-during-traffic-stop/article_3cfe0fd0-f4a3-11eb-bd31-03979dc83307.html) (last visited Mar. 23, 2022); *Parolee Arrested With AR-15 Ghost Gun, Fake Law Enforcement Badge*, *NBC Palm Springs* (Aug. 13, 2021), available at <https://nbcpalm Springs.com/2021/08/13/parolee-arrested-with-ar-15-ghost-gun-fake-law-enforcement-badge> (last visited Mar. 23, 2022); *Georgetown Arrest of a Felon Leads to Recovery of Ghost Gun*, *Seattle Police Department* (Nov. 8, 2021), available at <https://spdblotter.seattle.gov/2021/11/08/georgetown-arrest-of-a-felon-leads-to-recovery-of-ghost-gun> (last visited Mar. 23, 2022).

sought to make clear that unformed blocks of metal, and other similar articles only in a primordial state<sup>49</sup> would not—without more processing—be considered a “partially complete” frame or receiver that is captured under the definition of “frame or receiver.”

### 5. Definition of “Destroyed Frame or Receiver”

The fourth supplement proposed to exclude from the definition of “frame or receiver” any frame or receiver that has been destroyed. This proposed definition described a destroyed frame or receiver as one permanently altered not to provide housing or a structure that may hold or integrate any fire control or essential internal component, and that may not readily be assembled, completed, converted, or restored to a functional state. The proposed definition set forth nonexclusive acceptable methods of destruction, which had been provided by ATF in its past guidance.<sup>50</sup>

### C. Definition of “Readily”

The Department proposed to add the term “readily” to 27 CFR 478.11 and 479.11 and define it as “a process that is fairly or reasonably efficient, quick, and easy, but not necessarily the most efficient, speedy, or easy process.” 86 FR at 27730, 27747, 27751. It further listed factors relevant in applying this proposed definition, such as time, ease, expertise, equipment, availability, expense, scope, and feasibility, with brief examples describing these factors. *Id.* The proposed definitions and factors are based on case law interpreting “may readily be converted to expel a projectile” in 18 U.S.C. 921(a)(3)(A) and “can be readily restored to shoot” in 26 U.S.C. 5845(b)–(d). *See id.* at 27730 & n.58. The NPRM explained that defining the term “readily” was necessary to determine when a weapon, including a weapon parts kit, a partially complete or damaged frame or receiver, or an aggregation of weapon parts becomes a “firearm” regulated under the GCA and NFA.

<sup>49</sup> As used in this rule, the term “primordial” refers to an item, such as an unmachined block of metal, liquid polymer, or other raw material that is in its original natural form or at an early stage of development without substantial processing. *See* *Primordial*, *Oxford English Dictionary*, available at <https://www.oed.com/view/Entry/151373?redirectedFrom=primordial#eid> (last visited Mar. 23, 2022) (“that [which] constitutes the origin or starting point from which something else is derived or developed”).

<sup>50</sup> *See* 86 FR at 27729, 27746.

<sup>46</sup> This rule is consistent with ATF enforcement policy. *See* footnote 58, *infra*.

*D. Definitions of “Complete Weapon” and “Complete Muffler or Silencer Device”*

The Department proposed to add the terms “complete weapon” and “complete muffler or silencer device” to 27 CFR 478.11 and 479.11. The proposed definition of a “complete weapon” was a firearm, whether or not assembled or operable, containing all component parts necessary to function as designed but not a firearm muffler or silencer device. 86 FR at 27730. The proposed definition of a “complete muffler or silencer device” was a firearm muffler or firearm silencer, whether or not assembled or operable, containing all of the component parts necessary to function as designed. *Id.* These terms were proposed to explain when a frame or receiver of a firearm, including a firearm muffler or silencer, as the case may be, must be marked for identification.

*E. Definition of “Privately Made Firearm”*

The NPRM proposed adding the term “privately made firearm” to 27 CFR 478.11 and to define it as a firearm, including a frame or receiver, assembled by a person other than a licensed manufacturer, and not containing a serial number or other identifying marking placed by a licensed manufacturer at the time the firearm was produced. *See* 86 FR at 27730. The term would not include a firearm identified and registered in the NFRTR pursuant to 26 U.S.C., chapter 53, or any firearm made before October 22, 1968 (unless remanufactured after that date).<sup>51</sup>

*F. Definition of “Importer’s or Manufacturer’s Serial Number”*

The Department proposed to add the term “importer’s or manufacturer’s serial number” in 27 CFR 478.11 and to define it as the identification number, licensee name, licensee city or State, or license number placed by a licensee on a firearm frame or receiver or on a PMF. The NPRM explained that a serial number incorporating the abbreviated FFL number (also known in industry as

<sup>51</sup> The Federal Firearms Act of 1938 (repealed), the predecessor to the GCA, made it unlawful for a person to receive in interstate or foreign commerce a firearm that had the manufacturer’s serial number removed, obliterated, or altered. 15 U.S.C. 902(i) (1940). Regulations promulgated to implement this law required each firearm manufactured after July 1, 1958, to be identified with the name of the manufacturer or importer, a serial number, caliber, and model. However, there was an exception from the serial number and model requirements for any shotgun or .22 caliber rifle unless that firearm was also subject to the NFA. 26 CFR 177.50 (1959) (rescinded).

the “RDS key”) placed by a licensee on a PMF under the proposed rule met the definition of the “importer’s or manufacturer’s serial number.” The Department also explained that the proposed definition would help ensure that the serial numbers and other markings necessary to ensure tracing are considered the “importer’s or manufacturer’s serial number” protected by 18 U.S.C. 922(k) and numerous State laws, which prohibit possession of firearms with serial numbers that have been removed, obliterated, or altered. *See* 86 FR at 27730 n.62.

*G. Definition of “Gunsmith”<sup>52</sup>*

The Department proposed to amend the definition of “engaged in the business” as it applies to a “gunsmith” in 27 CFR 478.11 to clarify that businesses may be licensed as dealer-gunsmiths rather than as manufacturers if they routinely repair or customize existing firearms, make or fit special barrels, stocks, or trigger mechanisms, or mark firearms as a service performed on firearms not for sale or distribution by a licensee.<sup>53</sup> The proposed amendment was also for the purpose of providing greater access to professional marking services so that persons who engage in the business of identifying firearms for nonlicensees may become licensed as dealer-gunsmiths solely to provide professional PMF marking services.

*H. Marking Requirements for Firearms*

1. Information Required to be Marked on the “Frame or Receiver”

To properly implement the new definitions, the Department proposed to amend 27 CFR 478.92(a) and 479.102 to explain how and when markings must be applied on each part defined as a frame or receiver, particularly since there could have been more than one part of a complete weapon, or complete muffler or silencer device, which is the frame or receiver (*i.e.*, when ATF has not identified specific part(s) as the frame or receiver). Under the NPRM,

<sup>52</sup> The term “gunsmith” is not used in the GCA; however, the Firearm Owners’ Protection Act, Public Law 99–308 (1986), amended the GCA to define “engaged in the business” as applied to dealers to clarify when gunsmiths must have a license. *See* 18 U.S.C. 921(a)(11)(B), (a)(21)(D); 132 Cong. Rec. 9603–04 (1986) (statement of Sen. McClure).

<sup>53</sup> This rule would supersede ATF Ruling 2010–10, which allows gunsmiths under specified conditions to engage in certain manufacturing activities for licensed manufacturers. This change was proposed to eliminate a significant source of confusion among regulated industry members and the public as to who needs a license to manufacture firearms. *See Broughman v. Carver*, 624 F.3d 670 (4th Cir. 2010) (distinguishing dealer-gunsmiths from manufacturers).

each frame or receiver of a new firearm design or configuration manufactured or imported after the publication of the final rule was proposed to be marked with a serial number, and *either*: (a) The manufacturer’s or importer’s name (or recognized abbreviation), and city and State (or recognized abbreviation) where the manufacturer or importer maintains their place of business, or in the case of a maker of an NFA firearm, where the firearm was made; or (b) the manufacturer’s or importer’s name (or recognized abbreviation), and the serial number beginning with the licensee’s abbreviated FFL number as a prefix, which is the first three and last five digits, followed by a hyphen, and then followed by a number (which may incorporate letters and a hyphen) as a suffix, *e.g.*, “12345678-[number].” The serial number (with or without the FFL prefix) identified on each part of a weapon defined as a frame or receiver was proposed to be the same number, but could not duplicate any serial number(s) placed by the licensee on any other firearm.

The NPRM proposed that licensed manufacturers and importers could continue to identify the additional information on firearms (other than PMFs) of the same design and configuration as they existed before the effective date of the final rule under the prior content rules, and any rules necessary to ensure such identification would have remained effective for that purpose. This proposed provision was intended to make the transition easier and reduce production costs incurred by licensees.

Except for silencer parts transferred by manufacturers to other qualified manufacturers and dealers for completion or repair of devices, no change was proposed to the existing requirement that each part defined as a machinegun or silencer that is disposed of separately and not part of a complete weapon or device be marked with all required information, because individual machinegun conversion and silencer parts are “firearms” under the NFA that must be registered in the NFRTR. 26 U.S.C. 5841(a)(1), 5845(a), (b). However, for frames and receivers, and individual machinegun conversion or silencer parts defined as “firearms” that are disposed of separately, the proposed rule allowed the model designation and caliber or gauge to be omitted if it is unknown at the time the part is identified. *See* 86 FR at 27731.

2. Size and Depth of Markings

The Department did not propose changes to the existing requirements for size and depth of markings in 27 CFR

478.92(a)(1) and 479.102(a), but for sake of clarity, proposed to consolidate them into a standalone paragraph.

### 3. Period of Time To Identify Firearms

The Department proposed to identify the point at which manufacturers would be required to place markings on firearms. The NPRM proposed that complete weapons or complete muffler or silencer devices, as defined in the rule, would be allowed to be marked up to seven days from completion of the active manufacturing process for the weapon or device, or prior to disposition, whichever is sooner. Except for silencer parts produced by qualified manufacturers for transfer to other licensees to complete or repair silencer devices, parts defined as a frame or receiver, machinegun, or firearm muffler or firearm silencer that are not component parts of a complete weapon or device when disposed of would be allowed to be marked up to seven days following the date of completion of the active manufacturing process for the part, or prior to disposition, whichever is sooner. Adding this proposed language would codify ATF Ruling 2012–1, which explained that, whether the end product is to become a complete weapon or device, or a frame or receiver to be disposed of separately, it is reasonable for a licensed manufacturer to have seven days following the date of completion of the entire manufacturing process in which to mark a firearm manufactured and record its identifying information in the manufacturer's permanent records.

### 4. Marking of “Privately Made Firearms”

The Department proposed to amend 27 CFR 478.92 to require FFLs to mark, or supervise the marking of, the same serial number on each part of the weapon defined as frame or receiver (as defined in the rule) of a PMF that the licensee acquired, but not duplicate any serial number(s) placed on any other firearm. The marking would begin with the FFL's abbreviated license number (first three and last five digits) as a prefix, followed by a hyphen, and then followed by a number as a suffix (e.g., “12345678-[number]”). Unless previously identified by another licensee, PMFs acquired by licensees on or after the effective date of the rule were proposed to be marked in this manner within seven days of receipt or other acquisition (including from a personal collection), or before the date of disposition (including to a personal

collection), whichever is sooner.<sup>54</sup> For PMFs acquired by licensees before the effective date of the rule, the proposed rule would require licensees to mark or cause them to be marked by another licensee either within 60 days from the effective date of a final rule, or before the date of final disposition (including to a personal collection), whichever is sooner.<sup>55</sup>

Consistent with the language and purpose of the GCA, the NPRM explained that this proposed provision was necessary to allow ATF to trace all firearms acquired and disposed of by licensees, prevent illicit firearms trafficking, and provide procedures for FFLs and the public to follow with respect to PMF transactions with the licensed community. The proposed rule further noted that this provision was crucial in light of advances in technology that allow unlicensed, including prohibited, persons easily and repeatedly to produce firearms at home from parts ordered online, or by using 3D printers or personally owned or leased equipment. Such privately made firearms have made and will continue to make their way to the primary market in firearms through the licensed community.<sup>56</sup>

At the same time, nothing in the proposed rule restricted persons who are not otherwise prohibited from possessing firearms from making their own firearms without markings solely for personal use, nor did the proposed rule require individuals to mark PMFs when they occasionally acquire them for a personal collection, or sell or transfer them from a personal collection to unlicensed in-State residents in accordance with Federal, State, and local law. Further, the NPRM would not require FFLs to accept any PMFs, or to mark PMFs themselves, or to provide services to place identification marks on PMFs. Licensees would be able to arrange for individuals who wish to transfer PMFs to licensees to have them marked by another licensee before accepting them, provided they are properly marked in accordance with the proposed rule.

<sup>54</sup> Under this rule, licensed collectors would only need to mark PMFs they receive that are defined as “curios or relics.” See 27 CFR 478.11 (definitions of “firearm” and “curios or relics”).

<sup>55</sup> Handguns that are 3D-printed are also subject to the registration and taxation requirements of the NFA if they have a smooth bore and are capable of being concealed on the person, thereby falling within the definition of “any other weapon” under the NFA. See 26 U.S.C. 5845(e).

<sup>56</sup> Under Federal law, for example, certain firearm transactions must be conducted through FFLs. See 18 U.S.C. 922(a)(5) (prohibiting any person other than a licensee, subject to certain limited exceptions, from selling or delivering a firearm to an unlicensed out-of-state resident).

### 5. Meaning of Marking Terms

An additional amendment to 27 CFR 478.92 and 479.102 was proposed to clarify the meaning of the terms “legible” and “legibly” to ensure that “the identification markings use exclusively Roman letters (e.g., A, a, B, b, C, c) and Arabic numerals (e.g., 1, 2, 3), or solely Arabic numerals, and may include a hyphen,” and that the terms “conspicuous” and “conspicuously” are understood to mean that the identification markings are capable of being easily seen and unobstructed by other markings when the firearm is assembled. 86 FR at 27733. These would clarify the meaning of those terms as explained in ATF Ruling 2002–6 (“legible”), and ATF's final rule at 66 FR 40599 (Aug. 3, 2001) (referencing U.S. Customs Service regulations on the definition of “conspicuous”).

### 6. Alternate Means or Period of Identification

The proposed rule would not alter the Director's existing ability to authorize other means of identification, or a “marking variance,” for any part defined as a firearm (including a machinegun or a silencer), or the process for such a variance.

### 7. Destructive Device Period of Identification

The proposed rule specified a seven-day grace period in which to mark all completed firearms, including destructive devices (similar to other firearms), and would have allowed ATF to grant a variance from this period. There were no proposed changes to the marking requirements for destructive devices.

### 8. Adoption of Identifying Markings

The Department proposed allowing licensed manufacturers and importers to adopt an existing serial number, caliber/gauge, model, or other markings already identified on a firearm, provided that they legibly and conspicuously place, or cause to be placed, on each part (or part(s)) defined as a frame or receiver, either the FFL's name (or recognized abbreviation), and city and State (or recognized abbreviation) where they maintain their place of business; or their name (or recognized abbreviation) and their abbreviated FFL number, as described in Section III.H.1 of this preamble, followed by the existing serial number (including any other abbreviated FFL prefix) as a suffix, e.g., “12345678-[serial number],” to ensure the traceability of the firearm. This language was proposed to supersede ATF Ruling 2013–3 as it applied to licensed manufacturers and importers.

The proposal was aimed at avoiding multiple markings on firearms that could be confusing to law enforcement and alleviate concerns of some manufacturers and importers regarding serial number duplication when firearms are remanufactured or imported.

#### 9. Firearm Muffler or Silencer Parts Transferred Between Qualified Licensees

Licensed and qualified firearm muffler or silencer manufacturers routinely transfer small internal muffler or silencer components to each other to produce complete devices. Licensees qualified under the NFA routinely do the same when repairing existing devices. Because of the difficulties and expense of marking and registering small individual components used to commercially manufacture a complete muffler or silencer device with little public safety benefit, the NPRM proposed to allow qualified manufacturers to transfer parts defined as a firearm muffler or silencer to other qualified manufacturers without immediately identifying or registering them. Once the new device was completed with the part, the manufacturer would be required to identify and register the device in the manner and within the period specified in the proposed rule for a complete device. Likewise, the NPRM proposed to allow qualified manufacturers to transfer muffler or silencer replacement parts to qualified manufacturers and dealers to repair existing devices already identified and registered in the NFRTR. Further, the rule proposed to amend the definition of “transfer” to clarify that temporary conveyance of a lawfully possessed NFA firearm, including a silencer, to a qualified manufacturer or dealer for the sole purpose of repair, identification, evaluation, research, testing, or calibration, and return to the same lawful possessor is not a “transfer” requiring additional identification or registration in the NFRTR.<sup>57</sup> The proposed changes were intended to reduce the practical and administrative problems of marking and registering silencer parts by the regulated industry, and to avoid a potential resource burden on ATF to process numerous tax-exempt

<sup>57</sup> The definition of “transfer” in the NFA only includes “selling, assigning, pledging, leasing, loaning, giving away, or otherwise disposing of” a firearm. 26 U.S.C. 5845(j); see also *United States v. Smith*, 642 F.2d 1179, 1182 (9th Cir. 1981) (“We cannot agree that Congress intended to impose a transfer tax and require registration whenever mere physical possession of a firearm is surrendered for a brief period.”).

registration applications with little public safety benefit.<sup>58</sup>

#### 10. Voluntary Classification of Firearms and Armor Piercing Ammunition

As described in the NPRM, for many years, ATF has acted on voluntary requests from persons, particularly manufacturers who are developing new products, by issuing determinations or “classifications” on whether an item is a “firearm” or “armor piercing ammunition” as defined in the GCA or NFA. The Department proposed to clarify the existing process by which persons may voluntarily submit such requests to ATF. The NPRM proposed that requests be submitted in writing, or on an ATF form, executed under the penalties of perjury with a complete and accurate description of the item, the name and address of the manufacturer or importer thereof, and a sample of such item for examination along with any instructions, guides, templates, jigs, equipment, tools, or marketing materials that are made available to the purchaser or recipient of the item. Upon completion of the examination, ATF would return the sample to the person who made the request unless a determination was made that return of the sample would be, or place the person, in violation of law. The NPRM also proposed to codify ATF’s policy of not evaluating a firearm accessory or attachment “unless it is installed on the firearm(s) in the configuration for which it is designed and intended to be used,” and further explained that the Director’s determination would not be applicable to or authoritative with respect to any other sample, design, model, or configuration. 86 FR at 27734.

#### I. Recordkeeping

##### 1. Acquisition and Disposition Records

The Department proposed minor amendments to 27 CFR 478.122, 478.123, 478.125, and 478.125a, pertaining to the acquisition and disposition records maintained by

<sup>58</sup> These changes are consistent with ATF enforcement policy. See *NFA Handbook*, ATF E-Publication 5320.8, sec. 7.4.6, p.46, sec. 9.5.1, p. 60 (revised April 2009). With regard to silencer repairs, in order to avoid any appearance that an unlawful “transfer” has taken place, ATF recommends that an Application for Tax Exempt Transfer and Registration of Firearm, ATF Form 5, be submitted for approval prior to conveying the firearm for repair or identifying the firearm. The conveyance may also be accomplished by submission of a letter from the registrant to the qualified FFL advising the FFL that the registrant is shipping or delivering the firearm for repair/identification and describing the repair or identification. Return of the registered silencer to the registrant may likewise be accomplished by submission of an ATF Form 5 or by a letter from the FFL to the registrant that accompanies the silencer.

importers, manufacturers, and dealers. Due to the possibility that a firearm may have more than one frame or receiver as defined in the proposed rule, and the changes to marking regulations, the rule proposed to make certain words plural, (e.g., manufacturer(s), importer(s), and serial number(s)) in the recordkeeping regulations for the formatting of FFL records, as applicable. These proposed changes were considered necessary to ensure that FFLs record more than one manufacturer, importer, or serial number, if applicable, when acquiring or disposing of firearms with multiple components marked as the frame or receiver, or firearms that have been remanufactured or reimported by another licensee. This is consistent with prior ATF guidance to the firearms industry.<sup>59</sup>

The rule also proposed to amend 27 CFR 478.122 and 478.123 to require licensed importers and manufacturers to consolidate their records of importation, manufacture, or other acquisition, and their sale or other disposition in a format containing the applicable columns specified in a table under the regulation. These changes were proposed to supersede ATF Rulings 2011–1 and 2016–3.

The NPRM proposed to make minor clarifying changes to the format of the column titles required on the A&D Record in § 478.125(e). The proposed change was to make clear that both the name and license number (not the address) of a licensee from whom firearms are received and to whom they are disposed are recorded properly in the A&D Record.

The rule also proposed minor changes to § 478.125(f) to make clear that in the event the licensee records a duplicate entry with the same firearm and acquisition information, whether to close out an old record book or for any other reason, the licensee must record a reference to the date and location of the subsequent entry (e.g., date of new entry, book name/number, page number, and line number) to document the disposition. The NPRM explained the proposed change is needed to ensure that acquisition records are closed out when firearms are no longer in inventory<sup>60</sup> and would resolve problems that ATF has encountered during the inspection process and FFLs

<sup>59</sup> See FFL Newsletter, May 2012, at 5 (“If a firearm is marked with two manufacturer’s names, or multiple manufacturer and importer names, FFLs should record each manufacturers’ and importers’ [sic] name in the A&D record.”).

<sup>60</sup> This is consistent with prior ATF guidance to the firearms industry. See FFL Newsletter, Sept. 2011, at 5.



have encountered when responding to trace requests.

## 2. Firearms Transaction Records

Some technical amendments were proposed at 27 CFR 478.124 pertaining to information recorded on the Form 4473. Like changes to the recordkeeping regulations, the rule proposed to make certain words plural on the Form 4473 to ensure that FFLs would record more than one manufacturer, importer, and serial number, if applicable. The NPRM also proposed to remove from paragraph (f) a phrase that indicates that an FFL must fill out the firearm description information only after filling out the information about the transferee. The proposed deletion would clarify ATF Procedure 2020–1, which sets forth an alternative method of complying with section 478.124(f) for non-over-the-counter firearm transactions, and reflect the current process for completing the Form 4473.

## 3. Recordkeeping for “Privately Made Firearms”

The Department proposed changes to the regulations regarding recordkeeping by licensees to account for any voluntary receipts or other acquisitions (including from a personal collection) of PMFs, and corresponding dispositions (including to a personal collection). If a PMF were received or otherwise acquired by a licensee or disposed of, or imported, the proposed rule required the abbreviation “PMF” to be recorded as the manufacturer in the appropriate column, as well as the PMF serial number beginning with the abbreviated FFL number in the serial number column. The rule proposed requiring licensees to first record the PMF as an acquisition in the licensee’s A&D records upon receipt from the private owner (whether or not the licensee kept the PMF overnight). Once marked, the licensee would update the acquisition entry with the identifying information and record its return as a disposition to the private owner.

## 4. NFA Forms Update

The Department proposed minor technical amendments to 27 CFR 479.62, 479.84, 479.88, 479.90, and 479.141, pertaining to the Application to Make, NFA Form 1 (“Form 1”), the Application to Transfer, NFA Form 4 (“Form 4”), Tax Exempt Transfers—SOTs, NFA Form 3 (“Form 3”), Tax Exempt Transfers—Governmental Entities, NFA Form 5 (“Form 5”), and the Stolen or Lost Firearms Report, Form 3310.11 (“Form 3310.11”), respectively. The technical amendments were proposed to make certain words on

the forms plural (*i.e.*, manufacturer(s), importer(s), serial number(s)).

## 5. Importation Forms Update

The Department proposed minor technical amendments to 27 CFR 447.42, 447.45, 478.112, 478.113, 478.114, and 479.112, pertaining to the importation of firearms. Like the other recordkeeping changes, these technical amendments were proposed to ensure that more than one name, manufacturer, country, importer, or serial number, if applicable, would be recorded when completing importation forms.

## J. Record Retention

Given advancements in electronic scanning and storage technology, ATF’s acceptance of electronic recordkeeping, the reduced costs of storing firearm transaction records, the increased durability and longevity of firearms, and the public safety benefits of ensuring that records of active licensees are available for tracing purposes, the Department proposed to amend 27 CFR 478.129 to require FFLs to retain all records until business or licensed activity is discontinued, either on paper or in an electronic format approved by the Director,<sup>61</sup> at the business or collection premises readily accessible for inspection. Also, a proposed amendment to 27 CFR 478.50(a) would allow all FFLs, including manufacturers and importers, to store paper records and forms older than 20 years at a separate warehouse, which would be considered part of the business premises for this purpose and subject to inspection. These amendments would reverse a 1985 rulemaking allowing non-manufacturer/importer FFLs to destroy their records after 20 years.<sup>62</sup>

## IV. Analysis of Comments and Department Responses for the Proposed Rule

In response to the NPRM, ATF received 290,031 comments. Submissions came from individuals, including foreign nationals, lawyers, government officials, and various interest groups. Of the comments reviewed, there were nearly 114,400 comments that expressed support for the proposed rule. Of these, over 68,000 were submitted by individuals as form letters, *i.e.*, identical text that is often supplied by organizations or found online and recommended to be

<sup>61</sup> ATF previously approved electronic storage of certain records under the conditions set forth in ATF Rulings 2016–1 (Requirements to Keep Firearms Records Electronically) and 2016–2 (Electronic ATF Form 4473).

<sup>62</sup> See Retention of Firearms Transaction Records, 50 FR 26702 (June 28, 1985).

submitted to the agency as a comment. There were nearly 170,550 comments opposed to the rule, of which over 88,000 comments were submitted as form letters. For over 1,500 comments, the commenters’ positions could not be determined. The commenters’ grounds for support and opposition, along with specific concerns and suggestions, are discussed below.

## A. Issues Raised in Support of the Rule

Thousands of commenters broadly expressed support for the NPRM. Over 3,000 comments simply expressed support, stating “stop ghost guns,” but numerous other comments focused on the need to regulate “ghost guns” and were supportive of the proposed change to treat items like weapon parts kits the same as other firearms because the commenters believed such treatment is necessary for public safety. These commenters pointed to the rise and proliferation of “do-it-yourself” (“DIY”) firearms used in crimes and argued that it is easy for extremists, violent criminals, and traffickers, among others, to skirt the law and obtain untraceable guns without undergoing a background check. They stated that the rule was necessary to combat the emerging threat that “ghost guns” pose to public safety.

As discussed below, numerous other commenters ranging from lawmakers to prosecutors to religious, medical, and social policy-oriented organizations all raised various points as to why they were supportive of the Department’s proposed amendments to ATF regulations. Some commenters in support of the rule also provided suggestions on where they believed the regulatory text could be enhanced or further clarified.

## 1. Changes are Consistent With Law Comments Received

Commenters in support remarked that the proposed definitions are justified given the ease with which prohibited persons can intentionally circumvent Federal regulations to acquire unfinished frames or receivers that can be easily converted to functional firearms without a background check. Commenters agreed that ATF’s proposed definitions are consistent with Congress’s intent to regulate the core component of the firearm and that the plain meaning of “firearm” in the GCA includes any kits or nearly complete frames or receivers that can be readily converted into a firearm. One commenter noted the case *United States v. Drasen*, 845 F.2d 731, 736–37 (7th Cir. 1988), where the Seventh Circuit rejected the argument that a collection

of rifle parts cannot be a “weapon.” Other commenters agreed that ATF’s proposed rule would be a functional definition that preserves existing designs while defining the frame or receiver to include those with split or multi-piece frame or receiver configurations, and allows for flexibility over time to account for new technologies. They stated that this flexible approach, including manufacturers’ ability to submit a firearm to ATF and receive a classification on which component constitutes the receiver, would preserve the existing designations that ATF has made and minimize the burden on the gun industry.

Similarly, others agreed that the definition and factors set forth for the term “readily” are consistent with case law interpreting the term, and that the proposed definition and such case law provides manufacturers with fair warning on how the factors will be considered. Further, some commenters indicated that the proposed “readily” test is consistent with ATF’s past approach to reviewing unfinished receivers. Some commenters, such as the Brady Group, the District Attorney and County Counsel for the County of Santa Clara, and the Attorney General for the State of California stated that for a few decades, ATF had issued classification letters taking the position that some unfinished receivers, which are identical to the so-called “80% receivers” on the market today, were “firearms” under the GCA. They stated that, in that time period, ATF’s analysis was based on an approach that examined how quickly and easily an unfinished receiver or frame could be turned into a fully functional firearm—that is, whether it could “readily be converted” to function as the firearm it was specifically designed to be. The same commenters then asserted that, from around 2006 to the present, ATF changed its analysis and began to look at which machining operations still needed to be performed to determine whether a partially completed receiver or frame is a “firearm” under the GCA. Commenters believed that ATF’s change in interpretation led to an increase in the number of PMFs that have proliferated and that are being recovered in crime scenes.

#### Department Response

The Department acknowledges the commenters’ support for the proposed rule. The definitions in the proposed rule are consistent with the plain meaning of the term “firearm” in the GCA as it includes frames or receivers of weapons that are designed to or may

readily be converted to fire, not merely of weapons that are in a functional state that will expel a projectile. The Department agrees with commenters that any new definitions must be general enough to account for changes in technology and terminology while preserving ATF’s past classifications to minimize the impact on the firearms industry. The Department further agrees that the proposed definition of the term “readily” is consistent with case law that provides manufacturers with fair warning on how the factors in that definition are evaluated.

The Department also agrees that ATF took the position in past classification letters that some unfinished receivers were firearms because of the ease with which they can be made functional. However, ATF disagrees with commenters who stated that ATF changed its position from 2006 to the present concerning partially complete frames or receivers when it determined that specific machining operations had to be performed with respect to certain partially complete frames or receivers. Rather than a new or different test, how quickly and easily an item could be made functional is largely determined by which machining operations still needed to be performed. ATF has maintained and continues to maintain that a partially complete frame or receiver alone is not a frame or receiver if it still requires performance of certain machining operations (*e.g.*, milling out the fire control cavity of an AR-15 billet or blank, or indexing for that operation) because it may not readily be completed to house or hold the applicable fire control components. When a frame or receiver billet or blank is indexed or “dimpled,” it indicates the location for drilling or milling the holes or cavities necessary to install the fire control components necessary to initiate, complete, or continue the firing cycle.

However, this rule recognizes that the aggregation of a template or jig with a partially complete frame or receiver can serve the same purpose as indexing, making an item that is clearly identifiable as a partially complete frame or receiver into a functional one efficiently, quickly, and easily (*i.e.*, “readily”). Prior to this rule, ATF did not examine templates, jigs, or other items and materials in determining whether partially complete frames or receivers were “firearms” under the GCA. For this reason, ATF issued some classifications concluding that certain partially complete frames or receivers were not “frames or receivers” as defined in this rule. Thus, any classification requests for partially complete, disassembled, or

nonfunctional items or parts kits that were previously submitted to ATF, particularly those submitted without their associated templates, jigs, molds, instructions, equipment, or marketing materials as required by this rule, must be re-evaluated consistent with this rule to determine whether they would now be classified as “firearms,” “frames,” or “receivers.”

#### 2. Enhances Public Safety

##### Comments Received

Commenters supporting the proposed rule argued that the proposed rule is needed to make communities safer because under-regulation has made the rise of so-called ghost guns the fastest-growing public safety threat in the country. Some commenters emphasized that women who are victims of domestic abuse are severely affected by the rapid proliferation of unserialized firearms that can be easily acquired without a background check by convicted domestic violence offenders or those subject to a domestic violence restraining order. Healthcare and physicians’ organizations, which have called gun violence a public health epidemic, urged issuance of the proposed rule as a necessary step to reduce or prevent firearm-related injuries and death.

Various commenters, including Members of Congress, State lawmakers, and State and local prosecutors noted the uptick in the involvement of “ghost guns” in crimes and provided numbers demonstrating the rise of unserialized firearms recovered or used in crimes in their jurisdictions. For example, a comment from several State Attorneys General asserted that the Philadelphia Police Department recovered 287 unserialized guns in the first half of 2021, whereas in 2019, the Philadelphia police recovered just 95 unserialized guns, and that unserialized guns represented 2.23 percent of all guns recovered after gun crimes. Similarly, a comment from the Gun Violence Task Force of the New York County Lawyers Association asserted that in 2020, law enforcement in New York recovered 220 “ghost guns” compared to 72 in 2019, and 38 in 2018. They stated that this represented a 479 percent increase over a three-year period. One group asserted that law enforcement officers across the country are increasingly identifying trafficking rings that mass produce and sell untraceable firearms. These commenters stated that it is important to take proactive steps now, given that technology continues to rapidly evolve and makes it likely that these weapons will become easier and cheaper to

manufacture privately, especially for criminals intending to skirt the law.

#### Department Response

The Department acknowledges that the rule will enhance public safety by helping to ensure that more firearms may be traced by law enforcement to solve crime and arrest the perpetrators. As discussed in Section II.B of this preamble, ATF has also seen an exponential increase in the number of suspected PMFs recovered and reported for tracing. At the same time, by requiring sellers to have licenses and conduct background checks when firearm parts kits are manufactured and sold, the rule will help prevent potentially dangerous persons from acquiring those kits and easily making functional weapons.

#### 3. Prevents Companies From Exploiting Loopholes

##### Comments Received

Many commenters in support of the proposed rule argued that it was necessary to regulate so-called ghost guns because they believe that the primary reason people acquire them is for illicit purposes and that companies are exploiting existing loopholes in Federal regulations. Other commenters indicated that companies making and advertising DIY kits intentionally target prohibited purchasers or other dangerous parties by emphasizing the untraceable nature of their products. These companies, the commenters pointed out, frequently use the absence of a serial number and the ability to purchase the gun without a background check as selling points. Accordingly, these commenters argued it is evident that PMFs are not being used purely by hobbyists but are instead being made and sold for use on the street by violent criminals and gun traffickers precisely because their acquisition falls outside the scope of existing Federal regulations.

Some commenters made reference to ATF's Ruling 2015–1 that addressed inquiries from the public asking whether FFLs, or unlicensed machine shops, may engage in the business of completing, or assisting in the completion of, the manufacture of “firearm frames or receivers” (specifically from castings or blanks) for unlicensed individuals without becoming licensed as a manufacturer. These commenters asserted that the “ghost gun industry” ensures that its handgun frames and semiautomatic receivers do not meet ATF's 2015 interpretation of “frame or receiver” simply by not drilling into the frame or

receiver, shipping the mostly finished item to the purchaser, and providing detailed instructions on how to complete the firearm privately, often within minutes. This allows the industry to sell thousands of weapons with no serial numbers or background checks. One commenter emphasized the proposed multi-factor analysis for “readily” provides ATF with the necessary flexibility to adapt to innovations in firearms technology and likely prevents these parts kits manufacturers from developing products aimed at complying with a narrow construction of ATF regulations while skirting the spirit and intent of the GCA.

#### Department Response

The Department acknowledges the commenters' support for the proposed rule. This rule interprets the plain language of the GCA to update its regulations and clarify when a license is required, which part of a firearm must be marked, and what records must be maintained by licensees. The rule clarifies that the regulatory definitions of “firearm” and “frame or receiver” include weapon and frame or receiver kits with partially complete frames or receivers, which are therefore subject to regulatory controls under the GCA or NFA. Sellers of such parts kits are required to be licensed, and the frames or receivers of those firearms must be marked with a serial number and other identifying information. ATF anticipates that, as technology develops, this rule will help to ensure that persons who commercially produce partially complete frames or receivers that can efficiently, quickly, and easily be completed are licensed and conduct background checks when sold to unlicensed individuals. This will help prevent prohibited persons from acquiring such frames and receivers.

#### 4. Regulates “Privately Made Firearms” Like Other Firearms

##### Comments Received

Numerous commenters stated that PMFs should be regulated the same as any other firearm to ensure that manufacturers of weapon parts kits are licensed, adhere to recordkeeping requirements, and perform background checks on the purchasers of their products. Many commenters, including lawmakers from States such as Maryland, Massachusetts, and New York, stated that although some States that have enacted, or are working to pass, legislation regulating the possession or making of unserialized firearms, these laws cannot work in a

vacuum and that there are limits to what any one State can do. Less restrictive gun laws in neighboring States, they argued, undermine States with tighter restrictions. Unserialized firearms and unfinished frames and receivers will continue to flow into their communities. Federal regulation, they argued, is therefore needed to close the loophole; otherwise, law enforcement and State efforts to prevent gun violence and enforce their own laws will be severely undermined. For example, the County of Santa Clara District Attorney wrote that the lack of adequate serialization and recordkeeping of PMFs has made it difficult for law enforcement to apprehend individuals involved in ongoing criminal activity or firearms traffickers who supply criminals with weapons. Similarly, another prosecutors' organization stated that prosecutors rely on gun markings to generate leads and identify patterns, and the lack of serial numbers on PMFs undermines prosecutors' ability to effectively investigate and prosecute gun crime.

Lastly, some commenters stated that ATF should reject the inaccurate claims that the NPRM would make criminals out of law-abiding gun owners, stating that the rule would not reach or restrict private individuals legally allowed to possess a firearm who previously purchased nearly complete frames or receivers or ghost gun kits. These individuals, they argued, will be no more exposed to criminal liability than they are currently. They concluded that the NPRM will cut off the supply of ghost guns to traffickers and prohibited persons at its source and not burden law-abiding, good faith actors.

#### Department Response

The Department acknowledges commenters' support for the proposed rule, and notes that one of the primary purposes of the GCA is to assist State and local jurisdictions to control the traffic of firearms within their own borders through the exercise of their police power.<sup>63</sup> Under the rule as proposed and finalized, when licensees receive privately made or DIY firearms in the course of their licensed business or activity, they will need to mark or cause those firearms to be marked. This allows PMFs to be traceable by State and local law enforcement whenever they, like commercially produced firearms, are introduced into the regulated marketplace. At the same time, neither the GCA nor the proposed or final rule prohibits unlicensed

<sup>63</sup> See Public Law 90–351, sec. 901(a)(1), 82 Stat. 225.

individuals from marking (non-NFA) firearms they make for their personal use, or when they occasionally acquire them for a personal collection, or sell or transfer them from a personal collection to unlicensed in-State residents consistent with Federal, State, and local law. There are also no recordkeeping requirements imposed by the GCA or the proposed or final rule upon unlicensed persons who make their own firearms, but only upon licensees who choose to take PMFs into inventory. In sum, this rule does not impose any new requirements on law-abiding gun owners.

#### 5. Suggested Changes to the Text

Some commenters in support of the rule offered several suggestions on the text of the final rule while others asked that ATF take certain information into consideration. Notably, the combined comment submitted by 22 State Attorneys General in support of the proposed definitions offered seven suggestions for the final rule. The commenters' suggestions are addressed in the following paragraphs.

##### a. Definition of "Firearm" and Weapon Parts Kits

###### Comments Received

Some commenters urged ATF to clarify the relationship between a weapon parts kit and a partially complete frame or receiver. Although the proposed rule includes a "weapon parts kit" within the definition of "firearm" and separately defines a "partially complete, disassembled, or inoperable frame or receiver," the commenters stated that a partially complete frame is often sold as part of a weapon parts kit. Therefore, the commenters suggested that ATF clarify whether a parts kit must include a partially complete frame or receiver in order to satisfy the definition of "firearm."

Other commenters asked ATF to consider how to effectively regulate the domestic distribution of Computer Aided Manufacturing ("CAM") and Computer Aided Design ("CAD") files and other software and technology used to produce firearms. They explained that these types of files are just like weapon parts kits and can be used to "readily" assemble a working firearm. The commenters stated that the Department of Commerce currently regulates only the international distribution and export of CAM or CAD files for the production of firearms where such files are "ready for insertion into a computer numerically controlled machine tool, additive manufacturing

equipment, or any other equipment that makes use of" the files "to produce the firearm frame or receiver or complete firearm." 15 CFR 734.7(c). They suggested that there are opportunities for ATF to work alone or with other Departments, such as Commerce, to address the lack of regulation of the domestic distribution of CAM and CAD files and other software and technology used to produce firearms.

###### Department Response

The Department agrees with commenters that the NPRM supplement entitled "Partially Complete, Disassembled, or Inoperable Frame or Receiver" should make clear that it includes a "frame or receiver parts kit" with a partially complete, disassembled, or nonfunctional (replacing "inoperable" in the final rule to describe the item more accurately)<sup>64</sup> frame or receiver. The final rule incorporates that addition. However, a weapon parts kit need not have a partially complete frame or receiver, as defined in this rule, to satisfy the definition of "firearm" under section 921(a)(3)(A).<sup>65</sup> For example, a weapon parts kit that contains pieces of a multi-piece frame or receiver, as defined in this rule, may still meet the definition of "firearm" under section 921(a)(3)(A) if the kit "is designed to or may readily be completed, assembled, restored, or otherwise converted to expel a projectile by the action of an explosive."

Regarding computer files, this rule as proposed and finalized does not regulate the domestic distribution of CAM or CAD computer files. This rule implements the GCA, which does not regulate the information used to manufacture firearms. However, it would violate federal law to aid and abet (18 U.S.C. 2) or conspire (18 U.S.C. 371) with others to manufacture

<sup>64</sup> See footnote 122, *infra*.

<sup>65</sup> The existence of a frame or receiver is *not* a precondition to classifying a weapon as a firearm under section 921(a)(3)(A), as section 921(a)(3) defines a "firearm" in the disjunctive with each subpart separated by the disjunctive participle "or." See Black's Law Dictionary 1095 (6th ed. 1990) (defining the term "or" to mean "[a] disjunctive participle used to express an alternative or to give a choice of one among two or more things"); Antonin Scalia & Bryan A. Garner, *Reading Law: The Interpretation of Legal Texts* sec. 12, at 116 (2012) ("Under the conjunctive/disjunctive canon, and combines items while or creates alternatives . . . . With a conjunctive list, all . . . things are required—while with the disjunctive list, at least one of the [things] is required, but any one . . . satisfies the requirement."). Thus, while the term "firearm" in section 921(a)(3)(B) includes the frame or receiver of a weapon described in section 921(a)(3)(A), section 921(a)(3)(A) *does not require* a weapon to have a "frame or receiver," as each subpart qualifies, on its own, as a "firearm" for purposes of the GCA. Otherwise, section 921(a)(3)(A) would be superfluous.

firearms without a license (18 U.S.C. 922(a)(1)), which could include someone providing specially designed computer instructions for machines, such as Computer Numeric Control (CNC) machines or 3D printers, knowing that the purchaser is engaged in the business of producing firearms for sale or distribution without a license.

##### b. General Definition of "Frame or Receiver"

###### Comments Received

Some commenters in support of the proposed rule were concerned with the language "when the complete weapon is assembled" in the general definition of "frame or receiver," which was proposed to be defined, in part, as a "part of a firearm that, *when the complete weapon is assembled*, is visible from the exterior and provides housing or a structure designed to hold one or more fire control components" (emphasis added). The commenters stated that the italicized language makes the definition susceptible to being read to say that the part of a weapon that is the "frame or receiver" only becomes so when the complete weapon is assembled. To avoid that possible misreading, the commenters suggested the sentence should indicate it is a part of a complete weapon that is visible from the exterior when the complete weapon is assembled and provides housing designed to hold or integrate one or more fire control components.

Additionally, commenters also suggested the proposed definition of "frame or receiver," which refers to "[a] part of a firearm," be changed to "[a] part of a complete weapon," given that under both the GCA and regulatory definition, a "firearm" could mean just the "frame or receiver" of a weapon. Similarly, commenters suggested that "complete weapon" also be used instead of "firearm" where ATF proposes to define "fire control component" as "a component necessary for the firearm to initiate, complete, or continue the firing sequence." They suggested using "complete weapon" in other instances where the supplemental definition, like split or modular frame or receiver, uses the term "firearm" in the definition.

###### Department Response

The Department agrees that the phrase "when the complete weapon is assembled, is visible" in the proposed definition of "frame or receiver" could be misinterpreted to mean that the weapon or device must be assembled for a part to be defined as a frame or receiver. For this reason, and because

the definition of “conspicuous” in the marking requirements makes clear that markings must be capable of being easily seen with the naked eye during normal handling of the firearm and unobstructed by other markings when the complete weapon or complete muffler or silencer device is assembled (*i.e.*, visible),<sup>66</sup> the phrase “when the complete weapon is assembled, is visible” has been removed from the definition of “frame or receiver” in the final rule because it is unnecessary. Regarding the suggestion to substitute “complete weapon” for “firearm,” the Department does not believe that change is necessary because the final rule now makes clear the terms under “frame or receiver” will be defined in relation to the type of weapon, not to “firearms” generally.

### c. Supplement “Split or Modular Frame or Receiver”

#### Comments Received

Some commenters indicated that it appears an item may qualify under the supplement entitled “split or modular frame or receiver” only if the Director makes that determination based on certain factors. The commenters suggested that the definition would be enhanced if it also provided a standard that may be generally used to determine whether something is a “split or modular frame or receiver,” as well as additional factors that may inform how that standard is applied. In this way, the regulations would define “a split or modular frame or receiver” much as the proposed rule suggests defining “readily.” The commenters recommended inserting “each of those parts shall be a frame or receiver unless” before “the Director may determine” and then changing “may determine” to “determines.” Commenters also suggested making clear that the courts and the public, in

addition to the Director, may rely on the identified factors to determine whether something is a “partially complete, disassembled, or inoperable frame or receiver” for that definition.

#### Department Response

With respect to the definitional supplement “split or modular frame or receiver,” the Department disagrees that this provision as proposed was meant to be read as providing that a part may only qualify as a “split or modular frame or receiver” if the Director makes that determination based on the enumerated factors. This supplement was intended to inform the licensed industry and the public that if there is more than one part of a firearm falling within the proposed definition of “frame or receiver” (*i.e.*, more than one housing or structure for a fire control component), then ATF would use those factors when determining which specific part(s) of a split or modular weapon or device was the frame or receiver of that weapon or device. As with past ATF classifications, there would likely be only one such component specified in future designs.

In light of these and numerous other comments seeking more clarity as to how the definition of “frame or receiver” applies with respect to split and modular firearms, the Department is adopting three subsets of the proposed definition of “frame or receiver”—one that applies to handguns; one for rifles, shotguns, and projectile weapons other than handguns; and one for firearm mufflers and silencers. The Department agrees with numerous commenters that the proposed supplement to the definition entitled “split or modular frame or receiver” is difficult for persons to apply when the term “frame or receiver” was defined to include more than any housing for any fire control component. Because the final rule focuses on only a single component of a firearm based on the recommendations of commenters, there is no longer a need for a separate supplement entitled “split or modular frame or receiver” and it has not been adopted in the final rule.

However, while defining the term “frame or receiver” to focus on a single component and removing the supplement entitled “split or modular frame or receiver” provides clarity as to which part of a “split” frame or receiver (*i.e.*, with upper and lower housings for the bolt, breechblock, and trigger mechanism) is regulated, it does not provide clarity with respect to multi-piece frames or receivers that are designed to be disassembled into multiple modular subparts, more than

one of which may house or provide a structure for the applicable fire control component specified in this rule (*e.g.*, left and right halves of a frame or receiver). While these types of frames or receivers are relatively uncommon, ATF has seen an increase in multi-piece designs of frames or receivers. To address these new designs, the term “multi-piece frame or receiver” has been added to the final rule to mean a frame or receiver that may be disassembled into multiple modular subparts. To avoid confusion between multi-piece receivers that may be disassembled into modular subparts, and modular handguns with an internal removable chassis like the Sig P250/320 and Beretta APX Striker,<sup>67</sup> the definition expressly excludes the internal frame of a pistol that is a complete removable chassis that provides housing for the energized component, unless the chassis itself may be disassembled.

This rule clarifies for licensees which portion of a modular multi-piece frame or receiver they will need to identify with a serial number and additional identifying information. Pursuant to its authority under 18 U.S.C. 923(i) and 26 U.S.C. 5842(a), ATF is prescribing in this rule the manner in which licensed manufacturers and importers (and makers of NFA firearms) must identify multi-piece frames or receivers, as follows: (1) The outermost housing or structure designed to house, hold, or contain either the primary energized component of a handgun, the breech blocking or sealing component of a projectile weapon other than a handgun, or the internal sound reduction component of a firearm muffler or firearm silencer, as the case may be, is the subpart of a multi-piece frame or receiver that must be marked with the identifying information; (2) if more than one modular subpart is similarly designed to house, hold, or contain such a primary component (*e.g.*, left and right halves), each of those subparts must be identified with the same serial number and associated licensee information not duplicated on any other frame or receiver; and (3) the marked subpart(s) of a multi-piece frame or receiver must be presumed, absent an official determination by the Director or other reliable evidence to the contrary, to be part of the frame or receiver of a weapon.

The final rule provides that, once a modular subpart of a multi-piece frame

<sup>66</sup> Markings must also be clearly visible from the exterior because they may be needed to prove that a criminal defendant had knowledge that the serial number was obliterated or altered. *See, e.g., Lewis v. United States*, No. 3:12–0522, 2012 WL 5198090, at \*4 (M.D. Tenn. Oct. 19, 2012) (serial number obliterated on the “visible exterior” of a revolver); *State v. Shirley*, No. 107449, 2019 WL 2156402, at \*2 (Ct. App. Ohio May 16, 2019) (same); *cf. United States v. Sands*, 948 F.3d 709, 719 (6th Cir. 2020) (serial number is not altered or obliterated so long as it is “visible to the naked eye”); *United States v. St. Hilaire*, 960 F.3d 61, 66 (2d Cir. 2020) (“This ‘naked eye test’ best comports with the ordinary meaning of ‘altered’; it is readily applied in the field and in the courtroom; it facilitates identification of a particular weapon; it makes more efficient the larger project of removing stolen guns from circulation; it operates against mutilation that impedes identification as well as mutilation that frustrates it; and it discourages the use of untraceable weapons without penalizing accidental damage or half-hearted efforts.”).

<sup>67</sup> An internal removable chassis system (as found in the Sig P250/320 and Beretta APX Striker) that houses all components of a traditional pistol frame, to include incorporating the slide rails and housing for both the trigger and sear/hammer, is a complete pistol frame without the polymer grip.

or receiver has been marked and then aggregated (assembled or unassembled) with the other frame or receiver subparts, the marked part cannot be removed and replaced unless: (1) The subpart replacement is not a firearm under 26 U.S.C. 5845; (2) the subpart replacement is identified by the licensed manufacturer of the original subpart with the same serial number and associated licensee information in the manner prescribed by the rule; and (3) the original subpart is destroyed under the firearm licensee's control or direct supervision prior to such placement. These conditions are necessary because removing and replacing the identified component of a multi-piece frame or receiver would place the possessor in violation of 18 U.S.C. 922(k) (and, if an NFA firearm, 26 U.S.C. 5861(g) and (h)), which prohibits the possession of any firearm with the manufacturer's or importer's serial number removed. If a modular subpart of a multi-piece frame or receiver is sold separately, the rule requires that it be identified with an individual serial number. This is to ensure that the frame or receiver of the resulting weapon has traceable marks of identification. These clarifications with respect to the markings of a multi-piece frame or receiver are necessary for the final rule; otherwise, multi-piece frames or receivers could be sold or distributed piecemeal in individual subparts and replaced by the end user without any traceable marks of identification.

Finally, to ensure that industry members and others can rely on ATF's prior classifications, most prior ATF classifications and variants thereof, including those for externally powered weapons, have been grandfathered into the definition of "frame or receiver" along with examples and diagrams of those weapons, such as AR-15/M-16 variant firearms. The only exception is for classifications that a partially complete, disassembled, or nonfunctional frame or receiver, including a parts kit, was not, or did not include, a firearm "frame or receiver" as defined prior to this rule. Any such classifications, to include weapon or frame or receiver parts kits, would need to be resubmitted for evaluation. Further, if persons remain unclear as to which specific portion of a weapon or device falls within the definition of "frame or receiver," then they may still voluntarily submit a request to ATF as otherwise provided in this rule.

#### d. Definition of "Privately Made Firearm"

##### Comments Received

Some commenters suggested that ATF should explain that "made," as used in the definition of "privately made firearm," does not imply that firearms cannot be "manufactured" by private parties for purposes of other firearms laws. They stated that the proposed rule opted for "privately made firearm" instead of "privately manufactured firearms" to distinguish between what an FFL does (manufacture) and what a nonlicensee does (make). These commenters asserted that the NFA's definition of "make" demonstrates that the distinction between "make" and "manufacture" is not consistent throughout Federal law. Therefore, the commenters requested that ATF should clarify that its use of "made" in this regulation does not limit the meaning of either "made" or "manufacture" as used in this and other Federal laws and regulations.

##### Department Response

The Department agrees that the term "made" in the definition of "privately made firearm" was not meant to restrict the use of the terms "made" or "manufacture" with respect to the GCA or other firearms laws. As the preamble in the NPRM explained, the term "made" was incorporated into that definition merely to distinguish those firearms that were manufactured by licensees from those manufactured by unlicensed persons. *See* 26 U.S.C. 5845(i) ("The term 'make', and the various derivatives of such word, shall include manufacturing (other than by one qualified to engage in such business under this chapter), putting together, altering, any combination of these, or otherwise producing a firearm."). This rule is not intended to limit the meaning of "made" or "manufacture" in the GCA or any other Federal law, or with respect to State or local firearms laws.<sup>68</sup>

#### e. Marking of "Privately Made Firearms"

##### Comments Received

Some supportive commenters suggested that the final rule should clarify that any identifying marks must be placed on the metal insert of an otherwise undetectable PMF, not on any polymer or other nonmetal part or component, to ensure the marks are not worn away during normal use. The

<sup>68</sup> *See* 18 U.S.C. 927 (GCA does not preempt State or local law unless there is a direct and positive conflict with Federal law such that they cannot be reconciled or consistently stand together).

commenters believed this is what the preamble suggested, although the text of the proposed regulations did not do so explicitly.

The California Department of Justice stated that ATF should consider extending the PMF serialization requirement to owners as well as firearms licensees so as to foreclose the possibility that any PMFs will remain untraceable. This commenter stated that ATF could require owners of PMFs to register those weapons after a reasonable time frame, such as 60 days after the effective date of the regulation, which would ensure all PMFs are safely tracked by law enforcement.

##### Department Response

The Department agrees that the final rule should make clear that one of the acceptable methods of marking a PMF, or a commercially produced firearm, is to permanently embed a serialized metal plate into polymer or other nonmetal material. The final rule adds this as an acceptable example in addition to recognizing any other method approved by the Director. This can be accomplished by casting, molding, or another manufacturing method, such as 3D overprinting.<sup>69</sup>

The Department, however, disagrees that serialization should be limited to a particular method. The current regulations and this rule already require that identification marks be placed in a manner not susceptible of being readily obliterated, altered, or removed. While the commenters raised the point that the serial number with the Federal firearms licensee's abbreviated license number prefix would normally be placed on a metal insert to meet this requirement, the Department believes that other permanent methods and hardened materials for marking may be developed in the future as technology progresses.

<sup>69</sup> *See generally* Hayley Everett, *Lehvoss Group Leads Innovate UK Project for Overprinting High-Performance Polymers*, *3DPrintingIndustry.com* (Aug. 25, 2021), available at <https://3dprintingindustry.com/news/lehvoss-group-leads-innovate-uk-project-for-overprinting-high-performance-polymers-195071/> (last visited Mar. 23, 2022) ("Overprinting is a technique for designing multi-material parts when different materials are needed in various components of a part. Typically, a print is started and then paused midway whereby components can be embedded into the 3D print job. Then, the print process is resumed and allowed to 3D print over the components that have been embedded."); *MMF #5: A Guide to Embedding Components in 3D Printed Parts*, *Markforged.com*, available at <https://markforged.com/resources/blog/embedding-components-in-3d-printed-parts> (last visited Mar. 23, 2022); *How to Insert Internal Components with Markforged Composite 3D Printing*, *Hawkridgesys.com* (June 9, 2020), available at <https://hawkridgesys.com/blog/how-to-insert-internal-components-with-markforged-composite-3d-printing> (last visited Mar. 23, 2022).

Additionally, the GCA, 18 U.S.C. 922(p), only requires that firearms be *as detectable as the "Security Exemplar"* that contains 3.7 ounces of material type 17–4 PH stainless steel. This detectable material is likely to be metal, but it could be another substance. So long as the identification marks cannot readily be removed, obliterated, or altered, no additional marking requirement is necessary.<sup>70</sup> However, if the serial number or other markings may readily be removed, obliterated, or altered when placed using a particular method or material, then the licensee cannot adopt that serialization process to meet the identification requirements.

In response to the comment that the rule should extend the serialization requirement for PMFs to individual owners, unlike the NFA, the GCA does not impose a marking or recordkeeping requirement on unlicensed persons who are not engaged in a business or activity requiring a license. Nonetheless, under the GCA, 18 U.S.C. 927, State and local jurisdictions are free to enact their own requirements and restrictions on PMFs provided they do not directly and positively conflict with Federal law.

#### f. Marking of a "Firearm Muffler or Silencer"

##### Comments Received

At least one commenter welcomed the change under which silencers would only need to be marked on the designated frame or receiver of a silencer, and that minor components of silencers would not need to be engraved or registered when transferred between Special Occupation Taxpayers ("SOTs") for repair. This provision, the commenter stated approvingly, conforms policy to longstanding practice.

##### Department Response

The Department acknowledges commenters' support for the proposal not to require firearm mufflers or silencer parts other than the frame or receiver of a silencer to be marked or registered when transferred between qualified SOTs for repair. This rule finalizes that proposal with minor clarifying changes. The Department notes that this change would not adversely impact public safety because the frame or receiver of the complete firearm muffler or silencer devices being repaired are registered in the NFRTR and recorded as a disposition whenever an actual device is transferred.

<sup>70</sup> See 26 U.S.C. 5842(a) (serial number "may not be readily removed, obliterated, or altered").

#### g. Firearms Designed and Configured Before Effective Date of Rule

##### Comments Received

The group Everytown for Gun Safety Support Fund stated that ATF needs to make clear that its prior classifications of "nearly-complete" frames and receivers are no longer valid, as some sellers of these items display these classification letters on their websites to promote their products. The commenter said that this clarification was necessary to ensure these sellers do not continue to exploit outdated letters as legal cover for selling firearms illegally.

##### Department Response

The Department agrees with this comment. Certain prior ATF classifications of a "partially complete, disassembled, or nonfunctional frame or receiver" will not be grandfathered upon issuance of this final rule. In the past, ATF encountered situations in which incomplete frames or receivers were sent to ATF for classification without any of the other parts, jigs, templates, or materials that are sold or distributed with the item or kit. ATF then issued a classification that an unfinished item or kit was not a "frame or receiver" without the benefit of, or considering, such parts, jigs, templates, or information. In addition to not grandfathering these particular classifications, this rule finalizes the proposed process that any person seeking a voluntary classification must submit any associated templates, jigs, molds, equipment, or tools that are made available by the seller or distributor of the item or kit, to the purchaser or recipient of the item or kit, and any instructions, guides, or marketing materials if they will be made available by the seller or distributor with the item or kit. This is to ensure that a proper classification can be made under the new definitions. ATF will reconsider those firearm classifications, and any prior classifications of such items or parts kits would need to be resubmitted if a requester wants a voluntary determination.

#### h. Recordkeeping Requirements

##### Comments Received

The City of Oakland, California, which expressed support for the proposed rule, stated that their support is based on the NPRM taking into account the racially inequitable impacts of gun violence and over-policing. The City had several suggestions for the final rule to better account for the potential racial collateral consequences of the proposed rule and help Black and Brown communities disproportionately

harmed by gun violence to respond to PMFs already in their community. These suggestions included the following: (1) ATF should collect, retain, and study the information collected through the ATF Form 4473, which they stated should include demographic information; (2) ATF should provide clear guidance for local law enforcement on how to collect data on "ghost guns," including data that can be disaggregated by race, and ensure that implementing the rule does not lead to over-policing of Black and Brown communities; (3) ATF should work with the Executive Office for U.S. Attorneys and other Department partners on how to ensure that Black and Brown persons are not disproportionately charged with firearms-related offenses in Federal prosecutions; (4) ATF should include an explicit non-discrimination clause with respect to enforcement of the rule; (5) ATF should include model programs and best practices for how communities can respond to and mitigate the harm posed by ghost guns and gun violence, like Oakland Ceasefire; and (6) ATF should develop guidance for manufacturers and sellers to inform them of ATF's enforcement priorities.

##### Department Response

The Department acknowledges the commenter's support for the proposed rule; however, ATF cannot "collect, retain, and study" information on the ATF Forms 4473 for the purpose of evaluating potential racial collateral consequences of this rule. First, ATF does not retain the ATF Forms 4473, as they are owned and maintained by FFLs while they are in business. Therefore, the demographic and other information included on those forms is located throughout the country in the individual business records of FFLs. Second, the demographic information on that form (race and ethnicity) may only be used for limited purposes—collecting information required for the FFL to run a National Instant Criminal Background Check System ("NICS") background check,<sup>71</sup> and for certain law enforcement purposes, such as correctly

<sup>71</sup> After passage of the Brady Handgun Violence Prevention Act in 1993 (see 18 U.S.C. 922(t)), the FBI promulgated regulations to implement the NICS. These regulations, see 28 CFR 25.7, prescribe the search criteria used by NICS and state: "[T]he following search descriptors will be required in all queries of the system for purposes of a background check: (1) Name; (2) Sex; (3) Race; (4) Complete date of birth; and (5) State of residence" (emphasis added). This information is needed to facilitate proper identification by providing additional information that helps match—or rule out a match—between an individual and a potentially prohibiting record.

identifying the original purchaser of a firearm later used in a violent crime.<sup>72</sup> Although this demographic information is used for background check purposes, it is not maintained by the NICS. The NICS, which is administered by the FBI, is required by law to destroy all identifying information on prospective purchasers within 24 hours of providing a response that the transfer may proceed.<sup>73</sup> ATF may also inspect individual ATF Forms 4473 containing personally identifiable information held by FFLs, but only for limited regulatory or law enforcement functions—specifically, during inspections, and in the course of investigations, such as when tracing firearms linked to individual criminal investigations. Finally, statutory and appropriations restrictions prohibit ATF from promulgating any rule requiring the maintenance of a database or other information repository of the race or ethnicity of firearm purchasers or licensees.<sup>74</sup> For these reasons, the Department cannot require the systematic collection of such demographic information for statistical, programmatic, or other purposes as part of this rule.

Commenter's remaining suggestions regarding racial equality are beyond the scope of this rule.<sup>75</sup> This rule

<sup>72</sup> There are some limited circumstances under which the ATF Forms 4473 or information contained thereon is reported to ATF, for example, as part of the statutorily authorized demand letter program, pursuant to 18 U.S.C. 923(g)(5). Those circumstances are exceptions to the general rule, and even under those circumstances, ATF does not aggregate or centralize the demographic information contained on those forms.

<sup>73</sup> Public Law 112–55, sec. 511, 125 Stat. 632 (2011); 28 CFR 25.9.

<sup>74</sup> See 18 U.S.C. 926 (“No rule or regulation . . . may require that records required to be maintained under this chapter or any portion of the contents of such records, be recorded at or transferred to a facility owned, managed, or controlled by the United States or any State or any political subdivision thereof, nor any system of registration of firearms, firearms owners, or firearms transactions or dispositions be established.”); Public Law 103–159, sec. 103(i), 107 Stat. 1536 (1993) (“No department, agency, officer, or employee of the United States may—(1) require that any record or portion thereof generated by the [NICS] system established under this section be recorded at or transferred to a facility owned, managed, or controlled by the United States or any State or political subdivision thereof . . .”). Additionally, since 1979, congressional appropriations have prohibited ATF from using any funds or salaries in connection with the consolidation or centralization of records of acquisition and disposition of firearms maintained by FFLs. See Treasury, Postal Service, and General Government Appropriations Act, 1980, Public Law 96–74, 93 Stat. 560 (1979). This annual restriction became permanent in 2011. See Public Law 112–55, 125 Stat. 632 (2011).

<sup>75</sup> As a general matter, the Department's prosecutorial practices and priorities are set forth in the “Principles of Federal Prosecution” in the DOJ

implements the GCA, which was passed, in part, to help Federal, State, and local law enforcement prevent illicit firearms trafficking within their respective jurisdictions.<sup>76</sup> Specifically, this rule is intended, in part, to address the proliferation of unserialized “ghost guns,” which are increasingly being recovered at crime scenes, and law enforcement's difficulty in tracing them when recovered. The rule accomplishes this objective by clarifying the serialization and recordkeeping requirements that preserve ATF's ability to trace firearms for Federal, State, local, and international law enforcement wherever firearm violence may occur.

### B. Issues Raised in Opposition to the Rule

Thousands of commenters broadly expressed opposition to the NPRM with numerous form letters submitted. Over 7,000 commenters simply opposed without providing concrete reasons while the majority raised specified concerns about the proposed rule. ATF received comments from a variety of interested parties, including from FFL retailers and manufacturers, organizations, various lawmakers, knowledgeable gun enthusiasts, and persons with law enforcement backgrounds. As discussed below, numerous other commenters raised various concerns about the Department's proposed amendments to ATF regulations. These reasons included constitutional and statutory authority concerns, issues with the clarity and effect of the proposed definitions and changes to recordkeeping and marking requirements, and concerns about the public safety goals of the Department in promulgating this rule.

#### 1. Constitutional Concerns

##### a. Violates the Ex Post Facto Clause

###### Comments Received

Several hundred commenters opposed to the rule stated that it directly violates Clause 3 of Article I, Section 9, of the United States Constitution, which prohibits “ex post facto Law[s].” These commenters' opposition comes from their belief that, once the proposed rule

Justice Manual §§ 9–27.000, *et seq.* Section 9–27.260 (“Initiating and Declining Charges—Impermissible Considerations”) reads, in pertinent part, “In determining whether to commence or recommend prosecution or take other action against a person, the attorney for the government should not be influenced by . . . [t]he person's race, religion, gender, ethnicity, national origin, sexual orientation, or political association, activities, or beliefs.”

<sup>76</sup> See Public Law 90–351, sec. 901(a), 82 Stat. 225–26.

goes into effect, possession of items that are currently lawful would be no longer legal, and that the new prohibition would constitute an ex post facto law.

#### Department Response

The Department disagrees that the proposed rule violates the Ex Post Facto Clause. In *Calder v. Bull*, 3 U.S. (3 Dall.) 386 (1798), the Supreme Court set out four types of laws that violate the Ex Post Facto Clause:

1st. Every law that makes an action, done before the passing of the law, and which was innocent when done, criminal; and punishes such action. 2nd. Every law that aggravates a crime, or makes it greater than it was, when committed. 3rd. Every law that changes the punishment, and inflicts a greater punishment, than the law annexed to the crime, when committed. 4th. Every law that alters the legal rules of evidence, and receives less, or different, testimony, than the law required at the time of the commission of the offence, in order to convict the offender.

*Id.* at 390. Citing *Calder*, the Supreme Court has explained that a “law must be retrospective—that is, it must apply to events occurring before its enactment—and it must disadvantage the offender affected by it by altering the definition of criminal conduct or increasing the punishment for the crime” to be considered as falling within the ex post facto prohibition. *Lynce v. Mathis*, 519 U.S. 433, 441 (1997) (citation and internal quotation marks omitted). Courts have consistently recognized that regulating the continued or future possession of a firearm that is already possessed does not implicate the Ex Post Facto Clause because such a regulation does not criminalize past conduct. See, e.g., *United States v. Pfeifer*, 371 F.3d 430, 436–37 (8th Cir. 2004); *United States v. Mitchell*, 209 F.3d 319, 322 (4th Cir. 2000); *United States v. Brady*, 26 F.3d 282, 290–91 (2d Cir. 1994); *United States v. Gillies*, 851 F.2d 492, 495–96 (1st Cir. 1988) (Breyer, J.); *United States v. D'Angelo*, 819 F.2d 1062, 1065–66 (11th Cir. 1987); see also *Samuels v. McCurdy*, 267 U.S. 188, 193 (1925) (rejecting Ex Post Facto Clause challenge to statute that prohibited the post-enactment possession of intoxicating liquor, even when the liquor was lawfully acquired before the statute's enactment).

Here, penalties would result only from the future failure to mark firearms. For FFLs that already have unmarked firearms kits, frames, or receivers, they have 60 days from the effective date of the rule to appropriately mark these firearms. See 27 CFR 478.92(a)(4)(vi). Moreover, as this rule in other respects simply describes the proper application



of the terms Congress used in various provisions of the GCA, it does not impose liability independent of the preexisting requirements of those statutes. For these reasons, the Department disagrees with commenters' assertions that the rule violates the Ex Post Facto Clause.

#### b. Violates the First Amendment

##### Comments Received

A few commenters raised concerns that the proposed definitions violate the First Amendment. One commenter, an organization of artisans who create artistic arrangements that use "arbitrary components, some of which are semi-processed firearm components such as barrels [and] pistol slides," is concerned that if artisans are required to check with ATF on its opinion when using novel or arbitrary components in their artwork, this requirement would be a prior restraint on protected expression. The commenting organization stated that ATF's definitions are so vague that it does not know what ATF would consider novel "modular" designs that might be considered a frame or receiver. Further, the organization claimed that under the nonexclusive lists in the proposed definition just about any major gun part could check more than one box on ATF's "unlimited features" and be considered a frame or receiver. As such, the organization argued that the vague, open-ended definitions in the NPRM "would chill an artisan—one with a specific desire *not* to use any gun part which could be considered a 'firearm' and thus require the employ of an FFL—from engaging in First Amendment protected expression." Other commenters stated that the NPRM also raises First Amendment concerns because the Director would be able to determine when a component has become a firearm based on a company's instructions and how a company markets the product.

##### Department Response

The Department agrees with the commenters who asserted that the proposed definition was potentially confusing, but disagrees with the commenters' First Amendment objections. First, the Department recognizes that the definition as proposed would have made it more difficult for artisans and others to determine whether they would be acquiring a "frame or receiver" subject to regulation. For this reason, and because the Department agrees with commenters that the definition of "firearm" in 18 U.S.C. 921(a)(3)(B) is best read to mean that a single part of

a weapon or device is the frame or receiver, this rule adopts subsets of the proposed definition of "frame or receiver" to define "frame" and "receiver" so that licensees and the public can make this determination without an ATF classification. The Department has accordingly established new distinct definitions for frames with respect to handguns; receivers with respect to rifles, shotguns, and projectile weapons other than handguns; and frames or receivers for firearm mufflers or silencers.

The Department, however, does not agree with commenters that the rule would violate the First Amendment rights of artisans. The Supreme Court has held the First Amendment is not implicated by the enforcement of a regulation of general application not targeted at expressive activity. See *Arcara v. Cloud Books, Inc.*, 478 U.S. 697, 707 (1986) (upholding closure sanction of "an establishment used for prostitution" where respondents also "happen to sell books"). First Amendment scrutiny "has no relevance to a statute directed at . . . non-expressive activity," and applies "only where it was conduct with a significant expressive element that drew the legal remedy in the first place." *Id.* at 706–707; see also *Wright v. City of St. Petersburg, Florida*, 833 F.3d 1291, 1298 (11th Cir. 2016) ("First Amendment scrutiny ha[d] no relevance to [a trespass ordinance] directed at imposing sanctions on nonexpressive activity." (internal quotation marks omitted)); *Talk of the Town v. Department of Finance & Business Servs ex rel. Las Vegas*, 343 F.3d 1063, 1069 (9th Cir. 2003) (section of Las Vegas Code barring consumption of alcohol in places that lack valid liquor license—including exotic dancing establishments—"in no way can be said to regulate conduct containing an element of protected expression"). The definitions at issue are not targeting expressive conduct of any kind but are part of a "regulation of general application" clarifying the definition of frame and receiver and the marking requirements thereof. As such, the Department's position is that the First Amendment is not implicated by this rule.

However, in an abundance of caution and because artwork in general is expressive conduct entitled to First Amendment protection, see *Texas v. Johnson*, 491 U.S. 397, 404 (1989), and assuming this regulation somehow affects that conduct, the definitions still do not target expressive conduct and strict scrutiny review is not appropriate under the First Amendment analysis set out in *United States v. O'Brien*, 391 U.S.

367 (1968). "[W]hen 'speech' and 'nonspeech' elements are combined in the same course of conduct, a sufficiently important governmental interest in regulating the nonspeech element can justify incidental limitations on First Amendment freedoms." *Id.* at 376. Under an *O'Brien* analysis—

a government regulation is sufficiently justified [1] if it is within the constitutional power of the Government; [2] if it furthers an important or substantial governmental interest; [3] if the governmental interest is unrelated to the suppression of free expression; and [4] if the incidental restriction on alleged First Amendment freedoms is no greater than is essential to the furtherance of that interest.

*Id.* at 377.

First, "the Government may constitutionally regulate the sale and possession of firearms." *Wilson v. Lynch*, 835 F.3d 1083, 1096 (9th Cir. 2016). Second, courts have repeatedly held that public safety and the prevention of crime are not only substantial, but *compelling* governmental interests. See *United States v. Salerno*, 481 U.S. 739, 750 (1987); *Mai v. United States*, 952 F.3d 1106, 1116 (9th Cir. 2020); *Worman v. Healey*, 922 F.3d 26, 39 (1st Cir. 2019); *New York State Rifle & Pistol Ass'n v. Cuomo*, 804 F.3d 242, 261 (2d Cir. 2015); *Kolbe v. Hogan*, 849 F.3d 114, 139 (4th Cir. 2017); *Horsley v. Trame*, 808 F.3d 1126, 1132 (7th Cir. 2015). Third, "the Government's efforts to reduce gun violence" are not directed at any expressive conduct and cannot be construed to be related to the suppression of free expression in any way. *Wilson*, 835 F.3d at 1096–97. Fourth, the definitions do not ban the private making of a firearm nor the unregulated possession of non-frame or non-receiver firearms parts. Nor do the definitions ban the possession of a frame or receiver, but only require that a frame or receiver be marked; therefore, any burden is "incidental" and "minimal." *Id.* Because the regulation "satisfies each of the *O'Brien* conditions, it survives intermediate scrutiny." *Id.* at 1097 (finding ATF's Open Letter to Federal Firearms Licensees informing them that the presentation of a purported purchaser's medical marijuana registry card would give them cause to deny the sale as violating 18 U.S.C. 922(d)(3) did not violate the First Amendment even if having the card was considered expression). Therefore, even if the *O'Brien* standard applies, the definitions do not violate the First Amendment. See *Arcara*, 478 U.S. at 707 ("O'Brien . . .

has no relevance [to a rule regulating nonexpressive activity]).

c. Violates the Second Amendment  
Comments Received

A majority of commenters opposed to the NPRM objected to it on grounds that any changes to the definitions or the creation of new requirements that undermine the Second Amendment are unconstitutional, stating that the right to build firearms dates back to the founding of the Republic and that requiring markings on PMFs is an unconstitutional infringement of their Second Amendment rights. Commenters stated that ATF has encouraged hobbyists to fabricate firearms for their personal use and that the new requirements will restrain them from exercising their constitutional rights. Others objected saying that the NPRM failed to include relevant Second Amendment analysis. One commenter provided its own analysis, claiming that since *District of Columbia v. Heller*, 554 U.S. 570 (2008), a majority of gun control laws are examined under a reasonableness standard, which requires the regulation be a reasonable method for achieving the objectives of the regulation. Commenters claimed that ATF's proposed regulations would fail to meet the reasonableness standard because the evidence the agency cites actually proves that unfinished lower receivers are not even a marginal contributor to America's gun violence problem. Under their calculations, the commenters estimate that PMFs have been used only .837 percent of the time in deaths resulting from gun violence. Commenters concluded the proposed regulations are not a reasonable method to achieve the goal of reducing gun violence and therefore do not pass constitutional muster since the data does not demonstrate that regulating unfinished lower receivers will result in a statistically significant reduction of deaths from firearms.

Department Response

The Department disagrees with commenters that the new requirements are unconstitutional under the Second Amendment. First, the GCA and this rule do not prohibit individuals from assembling or otherwise making their own firearms from parts for personal use, such as self-defense or other lawful purposes. Neither the GCA nor this rule prohibits law-abiding citizens from completing, assembling, or transferring firearms without a license as long as those persons are not engaged in the business of manufacturing or importing firearms for sale or distribution, or

dealing in firearms, or transacting curio or relic firearms in a manner requiring a license. See 18 U.S.C. 922(a)(1), 923(a)–(b).

Second, this final rule is consistent with the Supreme Court's decision in *District of Columbia v. Heller*, 554 U.S. 570 (2008). There are compelling governmental interests in requiring privately made firearms to be marked and recorded whenever they are accepted into the business or collection inventories of licensees. The Supreme Court recognized in *Heller*, 554 U.S. at 626–27 & n.26, that “presumptively lawful regulatory measures” include those “imposing conditions and qualifications on the commercial sale of arms.” PMFs, like commercially produced firearms, must be able to be traced through the records of licensees when the PMFs are involved in crimes. PMFs cannot be traced through a licensee's records without the manufacturers' serial numbers placed on PMFs by licensees, as required by this rule. Cf. *United States v. Marzzarella*, 614 F.3d 85, 99 (3d Cir. 2010) (concluding that even if strict scrutiny were to apply, 18 U.S.C. 922(k) (prohibiting possession of firearms with obliterated serial numbers) would be upheld under the Second Amendment because “serial number tracing serves a governmental interest in enabling law enforcement to gather vital information from recovered firearms,” and “[b]ecause it assists law enforcement in this manner, we find its preservation is not only a substantial but a compelling interest”).

Commenters also suggested that a licensing requirement for the manufacture of firearms violates the Second Amendment. Preexisting law requires those engaged in the business of manufacturing, importing, or dealing firearms to be licensed. That requirement does not burden the ability of non-prohibited people to buy, sell, or possess firearms, and no court has opined that the Second Amendment protects the right to engage in the business of unlicensed manufacturing. *Heller* “did not touch in any way on an individual's right to manufacture or create those arms.” *Defense Distributed v. United States Dep't of State*, 121 F. Supp. 3d 680, 699 (W.D. Tex. 2015) (finding prepublication approval for software data files, project files, coding, and model for producing 3D printed firearms was a burden that fell “well short of that generally at issue in Second Amendment cases”). As stated above, the regulation does not ban the private

making of a firearm.<sup>77</sup> See *id.* (plaintiffs “are not prohibited from manufacturing their own firearms, nor are they prohibited from keeping and bearing other firearms”).

In rejecting a Second Amendment challenge to the analogous requirement to be licensed as a dealer in firearms, the Fourth Circuit found the licensing requirement “covers only the commercial sale of firearms. It affects only those who regularly sell firearms . . . . It explicitly excludes the vast majority of noncommercial sales.” *United States v. Hosford*, 843 F.3d 161, 166 (4th Cir. 2016). The same findings apply to persons “regularly” manufacturing firearms. Like section 922(a) of the GCA, the regulation “imposes a mere condition or qualification. Though framed as a prohibition against unlicensed firearm [commerce], the law is in fact a requirement that those who engage in the [business] of firearms obtain a license.” *Id.* And this licensing requirement “is a crucial part of the federal regulatory scheme.” *Id.* at 168; see also *United States v. Focia*, 869 F.3d 1269, 1286 (11th Cir. 2017) (prohibiting transfers between unlicensed individuals in different states “does not operate to completely prohibit [the defendant] or anyone else, for that matter, from selling or buying firearms;” instead, it “merely” imposes “conditions and qualifications on the commercial sale of arms” (internal quotation marks omitted)); *United States v. Nowka*, 2012 WL 2862061, at \*6 (N.D. Ala. May 10, 2012) (“[Plaintiff's] right to buy or sell a firearm is not abridged. It is regulated.”).

In some ways similar to the regulation, but in other ways more far-reaching, a San Diego City ordinance prohibits the possession, purchase, sale, receipt, and transportation of non-serialized firearms and unfinished frames and receivers. A lawsuit was brought challenging the ordinance as imposing “a blanket prohibition” upon a Second Amendment right to “self-manufacture all firearms in common use for self-defense and other lawful purposes.” *Fahr v. City of San Diego*, 2021 WL 4895974, at \*5 (S.D. Cal. Oct. 20, 2021). The district court disagreed, finding the ordinance “neither strips

<sup>77</sup> There is no historical support for the idea that private individuals *regularly* and easily manufactured firearms at home at the time of the Founding. “[F]irearms were not like apple pies, which a typical family could make at home . . . . [T]hey were items of commerce that were nearly impossible to produce without specialized equipment and skill.” David B. Kopel, *Does the Second Amendment Protect Commerce?*, 127 Harv L. Rev. Forum 230, 237 (Apr. 11, 2014).

persons of access to any serialized, California-compliant firearm, including AR–15s, nor does it prevent persons from assembling any class of California-compliant firearm using pre-serialized frames or receivers.” *Id.* at \*6. The court further found that, assuming the ordinance regulates conduct protected by the Second Amendment, it “does not severely burden Second Amendment-protected conduct, but merely regulates it.” *Id.* at \*9; *see also id.* at \*10 (because the ordinance “targets only non-serialized firearms and unfinished frames and unfinished receivers . . . that bypass background checks . . . and that are untraceable . . . this Court finds that the Ordinance is a reasonable fit for achieving the City’s objectives of decreasing the threat that ghost guns pose to the City’s stated substantial and important interests,” *i.e.*, “[p]ublic safety and crime prevention”).

Further, where commenters believed that the rule would require them to mark their PMFs, they argued that imposing such marking requirements is unconstitutional under the Second Amendment because the right to build firearms dates back to the founding of the Republic. Some commenters also believed that requiring markings of any kind on firearms is unconstitutional under the Second Amendment. As stated above, in *Marzzarella*, the Third Circuit rejected as “unavailing” the premise that “unmarked firearms” are “a constitutionally recognized class of firearms.” 614 F.3d at 93. The court found that requiring a visible serial number “d[oes] not bar” an individual “from possessing any otherwise lawfully marked firearm,” *id.* at 94, and thus the “burden imposed by the law does not severely limit the possession of firearms,” *id.* at 97. Moreover, this requirement “serves a law enforcement interest in enabling the tracing of weapons via their serial numbers” and in “assist[ing] law enforcement by making it possible to use the serial number of a firearm recovered in a crime to trace and identify its owner and source.” *Id.* at 98; *see also Fahr*, 2021 WL 4895974, at \*10 (“It is a matter of common sense that tracing firearms enhances public safety and aids crime solving.” (internal quotation marks omitted)); *id.* at \*11 (“firearms tracing has become a critical tool for modern firearms investigations and prosecutions, which the prevalence of ghost guns threatens to upend” (internal quotation marks omitted)).

Although commenters argued that *Heller* established a “reasonableness” standard under which the regulation fails because there is low usage of PMFs in crimes, this final rule provides

revised information demonstrating that the number of suspected PMFs recovered at crime scenes has been increasing exponentially. As a matter of common sense, unserialized firearms are inherently attractive to criminals, and therefore pose a risk to public safety. And, as noted in Section II.B of this preamble, there has been a substantial increase in the number of PMFs recovered from crime scenes in recent years. The agency does not need to wait until a certain number of crimes are committed in order to address a growing problem. Moreover, this rule serves the compelling governmental interest of preventing unserialized firearms from proliferating throughout the country, as recognized in *Marzzarella* decision. Finally, this rule is not a prohibition, but only a regulation that imposes a minimal burden on the possession of firearms.

#### d. Violates the Fourth Amendment Right to Privacy

##### Comments Received

Several commenters claimed the proposed rule violates their right to privacy under the Fourth Amendment. These commenters believe that the proposed rule requires persons to disclose firearms they have privately made on Form 4473, or that there is de facto registration occurring in the requirement that FFLs mark the PMFs they acquire. Other commenters stated that enforcement of the proposed rule would lead to a violation of their constitutional right to privacy in regards to their property if the government knows how many weapons each individual owns.

##### Department Response

The commenters are not correct in their belief that the rule requires persons to disclose firearms they have made on Form 4473. Under the proposed and final rule, there are no recordkeeping or marking requirements for personal, non-NFA firearms that are privately made. As to the recordkeeping and marking requirements for the licensees engaged in the business of manufacturing or dealing in firearms, those records are not in the custody of the government, but are retained by the licensee until they discontinue business. *See* 18 U.S.C. 923(g)(4). Additionally, while the proposed rule in no way establishes a registry of firearms, it is worthwhile noting that even actual registration of NFA firearms has never been found to violate a Fourth Amendment right to privacy.

The Department also does not agree that the proposed rule violates a

constitutional right to privacy in regard to commenters’ property if the government knows how many weapons an individual possesses. “The United States Constitution does not expressly guarantee a right to privacy, but the Supreme Court has held that a right to privacy does exist within the liberty component of the Fourteenth Amendment.” *See Padgett v. Donald*, 401 F.3d 1273, 1280 (11th Cir. 2005). Courts have recognized a privacy interest in avoiding disclosure of certain personal matters. *See id.*

“[N]ot all disclosures of private information will trigger constitutional protection.” *Doe No. 1 v. Putnam County*, 344 F. Supp. 3d 518, 540 (S.D.N.Y. 2018) (finding courts have found a right to privacy in a “limited set of factual circumstances” involving one’s personal financial or medical information, *i.e.*, information of a “highly personal nature”). “[T]he question is not whether individuals regard [particular] information about themselves as private, for they surely do, but whether the Constitution protects such information.” *DM v. Louisa County Dep’t of Human Services*, 194 F. Supp. 3d 504, 508–09 (W.D. Va. 2016) (finding no right to privacy of medical information) (internal quotation marks omitted). Information regarding firearms ownership or possession is of neither the medical nor financial variety, and no court has found this information to be constitutionally protected. *See Doe 1*, 344 F. Supp. 3d at 541 (“Disclosure of one’s name, address, and status as a firearms license [holder] is not one of the ‘very limited circumstances’ in which a right to privacy exists.”).

#### e. Violates the Fifth Amendment—Unconstitutionally Vague

##### Comments Received

Numerous commenters objected to the new definitions on grounds that the definitions are so vague that they violate the Due Process Clause of the Fifth Amendment. Citing to *Christopher v. SmithKline Beecham Corp.*, 567 U.S. 142, 155–56 (2012), commenters stated that ATF must “provide regulated parties ‘fair warning of the conduct [the regulation] prohibits or requires’”; otherwise, such ambiguity undermines due process and deprives market participants of notice about the law. Here, the commenters stated the definitions of “firearms,” “split or modular frame or receiver,” and “readily” offer no clear guidance or clarity in determining the scope of the terms and therefore are impermissibly vague. Further, commenters stated that

because the only way the public can get clarity is through the non-binding and non-public classification letters process, due process concerns are further compounded as entities are denied an opportunity to know what the law is and how to conform their conduct accordingly.

#### Department Response

In light of the many cases rejecting such challenges, the Department does not believe the term “readily” is vague. Nonetheless, to avoid any doubt, the final rule provides additional clarity on the application of “readily.” The rule now expressly excludes from the definitions of “frame or receiver,” a “forging, casting, printing, extrusion, unmachined body, or similar article that has not yet reached a stage of manufacture where it is clearly identifiable as an unfinished component part of a weapon (e.g., unformed block of metal, liquid polymer, or other raw material).” Thus, the definition of “readily” is not applied to items in a primordial state that are not clearly identifiable as unfinished weapon (i.e., pistol, revolver, rifle, or shotgun) frames or receivers. Moreover, the final rule explains that, when issuing a classification, the Director may consider any associated templates, jigs, molds, equipment, tools, instructions, guides, or marketing materials that are sold, distributed, or possessed with the item or kit, or otherwise made available by the seller or distributor of the item or kit, to the purchaser or recipient of the item or kit. The final rule further provides detailed examples of when an unfinished frame or receiver billet, blank, or parts kit may be considered a “frame or receiver.” For example, a partially complete billet or blank of a frame or receiver is a “frame or receiver” when it is sold, distributed, or possessed with a compatible jig or template, allowing a person using online instructions and common hand tools to complete the frame or receiver efficiently, quickly, and easily “to function as a frame or receiver,” a term which is also explained in the final rule. These revisions make it clear that manufacturers will be able to continue to obtain unfinished billets or blanks from their suppliers for further manufacture without requiring that the producer be licensed, mark such items, or maintain records of production and disposition. This is because their suppliers are not selling, distributing, or otherwise making available to their customers any jigs, templates, or other items that allow them to be readily converted to function as a frame or receiver.

The Department disagrees with commenters that the explanation in the proposed rule of how ATF would determine which portion of a “firearm” is a frame or receiver in a split or modular weapon, and what the term “readily” encompasses, is unconstitutionally vague. To begin, the rule explains ATF’s understanding of the statutory terms at issue and describes how those terms apply to particular circumstances, thus providing greater clarity about the statutory terms involved. To the extent commenters are concerned that the statutory requirements are unclear, that is an objection about the statute, not the rule. In any event, however, the terms employed in the rule are not unconstitutionally vague. “It is a basic principle of due process that an enactment is void for vagueness if its prohibitions are not clearly defined.” *Grayned v. City of Rockford*, 408 U.S. 104, 108 (1972). A law is impermissibly vague if it “fails to provide a person of ordinary intelligence fair notice of what is prohibited, or is so standardless that it authorizes or encourages discriminatory enforcement.” *FCC v. Fox Television Stations, Inc.*, 567 U.S. 239, 253 (2012) (internal quotation marks omitted). However, “[c]ondemned to the use of words, we can never expect mathematical certainty from our language.” *Grayned*, 408 U.S. at 110; see also *Ward v. Rock Against Racism*, 491 U.S. 781, 794 (1989) (“perfect clarity and precise guidance have never been required even of regulations that restrict expressive activity”).

Commenters objected to the term “readily” as vague. The term “readily” is defined in the rule to explain when a partially complete, disassembled, or nonfunctional frame or receiver is considered a “frame or receiver” under 18 U.S.C. 921(a)(3)(B); when a weapon, including a weapon parts kit, is considered a “firearm” under 18 U.S.C. 921(a)(3)(A); and when such frames or receivers are considered “destroyed.” These terms are easily understood to mean that if there is a weapon parts kit that may readily be completed, assembled, restored, or otherwise “converted” to a functional state (i.e., to expel a projectile), that parts kit is, itself, a “firearm.” Likewise, it is easy to understand that if there is a partially complete, disassembled, or nonfunctional frame or receiver that may readily be completed, assembled, restored, or otherwise converted to a functional state (i.e., to house or provide a structure for the applicable fire control component), that housing or structure

is, itself, a “frame” or “receiver.” No specialized knowledge is needed to understand how the term “readily” is to be applied. Persons who manufacture or possess weapon or frame or receiver parts kits, aggregations of parts, partially complete, or nonfunctional frames or receivers, are clearly on notice that what they are manufacturing, making, selling, distributing, receiving, or possessing are items subject to regulation if they only require minor additional work to be made functional. In sum, persons who make, transfer, receive, or possess partially complete firearm frames or receivers are on notice that those items are regulated if they may readily be converted.<sup>78</sup> On the other end of the spectrum, it is easy for persons to comprehend that if what was a “frame or receiver” of a weapon can no longer function as such, and cannot efficiently, quickly, or easily be converted back to a functional state, that item is no longer a “frame or receiver,” or “firearm,” because it has been destroyed.

Moreover, “readily” has been repeatedly—and consistently—defined by case law. In *New York State Rifle & Pistol Ass’n v. Cuomo*, 804 F.3d 242 (2d Cir. 2015), the plaintiffs challenged a State statute criminalizing the possession of magazines that “can be readily restored or converted to accept” more than ten rounds of ammunition as vague because “whether a magazine ‘can be readily restored or converted’ depends upon the knowledge, skill, and tools available to the particular restorer.” *Id.* at 266. The Second Circuit rejected that argument, finding that this “statutory language dates at least to the 1994 federal assault weapons ban” and “there is no record evidence that it has given rise to confusion at any time in the past two decades.” *Id.*

Indeed, “readily” dates back even further, appearing in the NFA’s definition of “machinegun,” where it has repeatedly been upheld against vagueness challenges. See *United States v. Catanzaro*, 368 F. Supp. 450, 453–54 (D. Conn. 1973) (rejecting argument that

<sup>78</sup> Forgings, castings, extrusions, and machined bodies of firearms that are clearly identifiable as incomplete firearm frames or receivers have been regulated for purposes of importation and exportation as “defense articles” since at least 1939. See *International Traffic in Arms, Ammunition, etc.*, 22 CFR 171.6, 1939 Supp. 1318; 32 CFR 1.6, 1939 Supp. 2326 (now 22 CFR 120.6 and 27 CFR 447.22). They are also considered “imported parts” for purposes of the prohibition against assembling non sporting semiautomatic rifles or shotguns under 18 U.S.C. 922(r). See 27 CFR 478.39(c)(1). Under this rule, only forgings, castings, and machined bodies that are clearly identifiable as a component part of a weapon and that are designed to, or may readily be completed, assembled, restored, or otherwise converted to a functional state are regulated as “frames” or “receivers.”

phrase “which may be readily restored to fire” in the NFA “is not sufficiently definite to provide adequate warning as to the kinds of weapons included”); *United States v. M-K Specialties Model M-14 Machinegun*, 424 F. Supp. 2d 862, 872 (N.D. W. Va. 2006) (the parties agreed “the ordinary meaning of the term ‘readily restored’ should be used when applying section 5845(b) [of the NFA] . . . the statute’s terms should be easily understood by a person of ordinary intelligence”).<sup>79</sup> While Congress did not define “readily,” courts have turned to the “common practice of consulting dictionary definitions to clarify their ordinary meaning.” *United States v. TRW Rifle 7.62X51mm Caliber, One Model 14 Serial 593006*, 447 F.3d 686, 689 (9th Cir. 2006) (internal quotation marks omitted). The “plain and unambiguous ordinary meaning of ‘readily’ may be defined by a temporal component . . . or a component related to a manner or methodology” and “must not be construed as an abstract phrase, but rather its contours should be determined in . . . context.” *Id.* at 690 (internal quotation marks omitted).

The Department disagrees with commenters that the explanation in the proposed rule of how ATF would determine which portion of a “firearm” is the frame or receiver in a split or modular weapon was unconstitutionally

vague. ATF has applied that criteria for many decades as to split or modular weapons. Nonetheless, because the Department agrees with commenters that the definition of “firearm” in 18 U.S.C. 921(a)(3)(B) is best read to mean a single part of a weapon or device as being “the” frame or receiver, the Department provides under the definition of “frame or receiver” new distinct sub-definitions for frames with respect to handguns; receivers with respect to rifles, shotguns, and projectile weapons other than handguns; and frames or receivers for firearm mufflers and silencers. The final rule does not adopt the proposed supplement entitled “Split or Modular Frame or Receiver.” The final rule also provides illustrative examples of ATF’s prior classifications that are grandfathered, and examples of when a partially complete, disassembled, or nonfunctional frame or receiver is considered readily completed, assembled, restored, or otherwise converted to a functional state. *See Parker v. Levy*, 417 U.S. 733, 754 (1974) (examples provided “considerable specificity” of “the conduct which they cover”). With these clarifications in the final rule, licensees, and the public, can make their own determinations to identify the frame or receiver of a weapon without an ATF classification.

These definitions use the terms with their ordinary meanings and in context, *see TRW Rifle*, 447 F.3d at 689, 690, and are sufficiently clear to “give the person of ordinary intelligence a reasonable opportunity to know what is prohibited,” *Village of Hoffman Estates v. Flipside, Hoffman Estates, Inc.*, 455 U.S. 489, 498 (1982) (citing *Grayned*, 408 U.S. at 108–09). Absolute certainty is not required. *See United States v. Hosford*, 843 F.3d 161, 171 (4th Cir. 2016) (laws “necessarily have some ambiguity, as no standard can be distilled to a purely objective, completely predictable standard.”); *Draper v. Healey*, 827 F.3d 1, 4 (1st Cir. 2016) (“if due process demanded [a] how-to guide, swaths of the United States Code, to say nothing of state statute books, would be vulnerable”); *United States v. Lachman*, 387 F.3d 42, 56 (1st Cir. 2004) (“The mere fact that a statute or regulation requires interpretation does not render it unconstitutionally vague.”); *Kolbe v. O’Malley*, 42 F. Supp. 3d 768, 800 (D. Md. 2014) (A “statute is not impermissibly vague simply because it does not spell out every possible factual

scenario with celestial precision.” (internal quotation marks omitted)).<sup>80</sup>

Commenters cite to *Christopher v. SmithKline Beecham Corp.*, 567 U.S. 142, 155–56 (2012), but that case did not involve constitutional vagueness claims at all. It instead addressed when *Auer* deference is due to an agency’s interpretation of its own ambiguous regulations. *Id.* Here, by contrast, ATF is promulgating new regulations implementing the NFA and GCA through a formal rulemaking procedure. And as explained above, the terms employed in this rule comport with ordinary usage and the case law interpreting those terms.

#### f. Violates the Fifth Amendment—Unconstitutional Taking

##### Comments Received

Commenters opposed to the NRPM asserted that the regulations would result in an unconstitutional taking under the Fifth Amendment. Commenters claimed that the government is obligated to compensate people who lost money based on the agency’s misrepresentations. One commenter argued that an unconstitutional taking would occur if FFLs are forced to either mark PMFs currently in their possession in accordance with the proposed rule, destroy the PMFs, or “voluntarily” turn the PMFs over to law enforcement officials within 60 days of the effective date of the final rule. The commenter claimed that the “voluntary” surrender to law enforcement officials is a government taking of personal property. The commenter relied on *Loretto v. Teleprompter Manhattan CATV Corp.*, 458 U.S. 419 (1982), where the Supreme Court explained that, with regard to the factual inquiry involved in a takings claim under *Penn Central Transportation Co. v. New York City*, 438 U.S. 104 (1978), a “governmental action” that results in “a permanent physical occupation of property” represents “a taking to the extent of the occupation, without regard to whether the action achieves an important public benefit or has only minimal economic impact on the owner.” 458 U.S. at 434–

<sup>80</sup> Moreover, to the extent there is uncertainty about a particular item, upon submission, ATF will render a classification, a service ATF has long provided. *See Sig Sauer, Inc. v. Brandon*, 826 F.3d 598, 599–600 (1st Cir. 2016); *see also United States v. Zhen Zhou Wu*, 711 F.3d 1, 15 (1st Cir. 2013) (rejecting a vagueness challenge to the regulatory framework of the Arms Export Control Act and noting there is a “determination process” to “allow private parties to obtain an official government answer on whether an item is covered . . . before they engage in potentially unlawful conduct, a feature that further mitigates any concern about the law trapping [the] unwary” (citation omitted)).

<sup>79</sup> *See also U.S. v. Wojcikiewicz*, 403 F. App’x 483, 486 (11th Cir. 2010) (same with disassembled rifles); *United States v. Kelly*, No. 05–4775, 2007 WL 2309761, at \*5 (4th Cir. Aug. 14, 2007) (the argument that 26 U.S.C. 5845(b) is unconstitutionally vague is meritless); *United States v. Kent*, 175 F.3d 870, 878 (11th Cir. 1999) (rejecting vagueness challenge where disassembled short-barreled Colt AR–15 could be readily restored to operate as a short-barreled rifle); *United States v. Drasen*, 845 F.2d 731, 737–38 (7th Cir. 1988) (rejecting vagueness challenge to the phrase “readily restored” in 26 U.S.C. 5845(c) defining “rifle”); *U.S. v. M-K Specialties Model M-14 Machinegun*, 424 F. Supp. 2d 862, 872 (N.D. W. Va. 2006) (rejecting vagueness challenge to the phrase “readily restored” in 26 U.S.C. 5845(b); *cf. Phelps v. Budge*, 188 F. App’x 616, 618 (9th Cir. 2006) (Nevada statute defining deadly weapon as, among other things, any weapon or device which was “readily capable of causing substantial bodily harm or death” was not unconstitutionally vague); *Coalition of New Jersey Sportsmen v. Whitman*, 44 F. Supp. 2d 666, 681 (D.N.J. 1999), *aff’d*, 263 F.3d 157 (3d Cir. 2001) (New Jersey statute criminalizing “any combination of parts from which an assault firearm may be readily assembled” was not unconstitutionally vague); *Botosan v. Paul McNally Realty*, 216 F.3d 827, 836–37 (9th Cir. 2000) (term “readily achievable” and factors set forth in the Americans with Disabilities Act “can hardly be considered vague”); *United States v. Quiroz*, 449 F.2d 583, 585 (9th Cir. 1971) (the definition of “firearm” in section 921(a)(3) was not unconstitutionally vague with respect to a “readily convertible” starter gun); *United States v. 16,179 Molso Italian .22 Caliber Winlee Derringer Convertible Starter Guns*, 443 F.2d 463, 464–65 (2d Cir. 1971) (same).

35. The commenter claimed that absent specific asset forfeiture instructions directing Federal law enforcement agencies to destroy any PMFs “voluntarily” turned in by FFLs, the proposed rule fails to set forth any safeguards that prevent Federal law enforcement agencies from repurposing the PMFs for their own use and therefore effectuates a regulatory taking of private property without just compensation.

#### Department Response

The Department disagrees that the regulation constitutes a taking, and further disagrees that it results in a compensable taking. In order to remain in compliance, FFLs are not required to destroy unmarked PMFs or surrender them to ATF. They can mark them, or have them marked, as required by regulation, which does not require any transfer or loss of property. However, if an FFL chooses to destroy a PMF, that is not compensable. Moreover, the Federal Circuit has recognized that, under Supreme Court precedent, there are certain exercises “of the police power that ha[ve] repeatedly been treated as legitimate even in the absence of compensation to the owners of the . . . property.” *Acadia Tech., Inc. v. United States*, 458 F.3d 1327, 1332–33 (Fed. Cir. 2006). As the Supreme Court articulated the doctrine, “[a] prohibition simply upon the use of property for purposes that are declared, by valid legislation, to be injurious to the health, morals, or safety of the community, cannot, in any just sense, be deemed a taking or an appropriation of property for the public benefit.” *Mugler v. Kansas*, 123 U.S. 623, 668–69 (1887); see *Acadia Tech.*, 458 F.3d at 1333.

The Federal Circuit has applied this precedent in situations where Federal law enforcement has acted pursuant to seizure statutes, and criminal laws, to find that no compensable taking exists. *AmeriSource Corp. v. United States*, 525 F.3d 1149, 1154 (Fed. Cir. 2008); *Acadia Tech.*, 458 F.3d at 1333. In doing so, the court emphasized that “[p]roperty seized and retained pursuant to the police power is not taken for a ‘public use’ in the context of the Takings Clause.” *AmeriSource*, 525 F.3d at 1153. In these decisions, the Federal Circuit found no taking occurs irrespective of whether the government had physically seized the property or rendered it worthless. *Id.* at 1153–54; *Acadia*, 458 F.3d at 1333.

The Federal Circuit and the Court of Federal Claims have also made clear that these principles apply with full force in analyzing the impact of firearms regulations promulgated pursuant to the

Federal power to regulate commerce. In *Mitchell Arms, Inc. v. United States*, 7 F.3d 212 (Fed. Cir. 1993), the Federal Circuit rejected a takings claim brought by a firearms business whose permits to import semiautomatic rifles were revoked. Similarly, in *Akins v. United States*, 82 Fed. Cl. 619 (2008), the Court of Federal Claims rejected takings claims, including a *per se* takings claim, after ATF reconsidered its prior classification decisions regarding the Akins Accelerator. The Court explained that “[p]roperty seized and retained pursuant to the police power is not taken for a ‘public use’ in the context of the Takings Clause.” *Id.* at 622 (quoting *AmeriSource*, 525 F.3d at 1153). And, citing *Mitchell Arms*, the *Akins* Court also found that the plaintiff was fully aware of the “potential for federal regulation of his invention” and his “expectation interest” was “not a property interest protected by the Fifth Amendment.” *Id.* at 624; see also *Maryland Shall Issue v. Hogan*, 353 F. Supp. 3d 400, 408–17 (D. Md. 2018) (rejecting takings claim arising from State ban on bump stocks), *aff’d*, 963 F.3d 356 (4th Cir. 2020); cf. *McCutchen v. United States*, 14 F.4th 1355, 1364–65 (Fed. Cir. 2021) (rejecting takings claim on the “related” ground that no taking occurs where the government “asserts a pre-existing limitation upon the [property] owner’s title” to require destruction of a banned weapon (internal quotation marks omitted)). Even under a takings analysis, the regulation would be analyzed under *Penn Central*, and the regulation would be upheld. Under *Penn Central*, a court considers: (1) The economic impact of the regulation on the claimant, (2) its interference with investment-based expectations, and (3) the character of the governmental action. 438 U.S. at 124.

No taking exists under *Penn Central*. A restriction “directed at the protection of public health and safety . . . is the type of regulation in which the private interest has traditionally been most confined and governments are given the greatest leeway to act without the need to compensate those affected by their actions.” *Rose Acre Farms, Inc. v. United States*, 559 F.3d 1260, 1281 (Fed. Cir. 2009). A plaintiff’s “reasonable investment-backed expectations are greatly reduced in a highly regulated field,” *Branch v. United States*, 69 F.3d 1571, 1581 (Fed. Cir. 1995), such as the firearms industry. And as the Supreme Court has made clear, “an owner of personal property ‘ought to be aware of the possibility that new regulation might even render his property economically worthless.’” See *Lucas v.*

*S.C. Coastal Council*, 505 U.S. 1003, 1027–28 (1992). As for the economic impact, licensees do not have to abandon or destroy anything; they need only mark PMFs with serial numbers as required by the GCA if they choose to take those items into inventory.

Commenters’ citation to *Loretto* is inapplicable. The *Loretto* decision states nothing about regulating the possession of inherently dangerous personal property. Instead, *Loretto* involved a challenge to a state law requiring a landlord to install cable television facilities on the landlord’s building. 458 U.S. at 421. The Court found a *per se* physical taking based upon the physical invasion of the landlord’s real property. *Id.* at 426. Here, in contrast, the government has not required anyone to transfer title of anything to the government and has not physically invaded anyone’s property. Moreover, even the physical seizure of highly regulated goods pursuant to the government’s police power has never been thought to constitute a *per se* taking. See *Kam-Almaz v. United States*, 682 F.3d 1364, 1372 (Fed. Cir. 2012); *AmeriSource*, 525 F.3d at 1153; *Acadia Tech.*, 458 F.3d at 1332–33.

To the extent commenters are arguing that a categorical regulatory taking under *Lucas* has occurred, they are incorrect. First, the *Lucas* test does not apply to valid exercises of the government’s police power in enforcing the criminal laws. That is the case even where personal property may become worthless as a result of the government’s action, which is not the case here. See *AmeriSource*, 525 F.3d at 1154; *Akins*, 82 Fed. Cl. at 621–23. *Lucas* also does not apply to the regulation of personal property of the type involved here. The Supreme Court has never held that even a complete ban on possessing dangerous personal property constitutes a *per se* taking under *Lucas* (or any *per se* test). The Supreme Court has explained that the categorical takings analysis applies only in the “relatively rare” and “extraordinary circumstance when no productive or economically beneficial use of land is permitted.” *Lucas*, 505 U.S. at 1017–18. Although the Court has had reason to consider *Lucas* on multiple occasions, it has never applied the rule to any type of property rights other than real property. See *McCutchen*, 14 F.4th at 1371–72 (“The cases in which the Supreme Court has applied *Lucas*’s total takings rule have involved real property, and Circuit Courts have not reached a clear consensus on how broadly to apply *Lucas*’s *per se* rule.”) (Wallach, J., concurring in result).

g. Violates the Fifth Amendment—Equal Protection Clause

#### Comments Received

Several commenters claimed that the proposed rule violates the Equal Protection Clause by targeting the products of certain law-abiding businesses, including by naming particular companies.<sup>81</sup>

#### Department Response

The Department disagrees that the proposed rule violates the Equal Protection Clause. If a “classification ‘impermissibly interferes with the exercise of a fundamental right or operates to the peculiar advantage of a suspect class,’ [a court will] subject the classification to strict scrutiny. Otherwise, [courts] will uphold the classification if it is ‘rationally related to a legitimate state interest.’” *Mance v. Sessions*, 896 F.3d 699, 711 (5th Cir. 2018) (citing *NRA v. ATF*, 700 F.3d 185, 211–12 (5th Cir. 2012)). There is no fundamental right to be engaged in the business of manufacturing firearms or to possess unserialized firearms. See *Defense Distributed*, 121 F. Supp. 3d at 699; *Marzzarella*, 614 F.3d at 93. Nor are firearms manufacturers a suspect class. Rational basis review therefore applies.

Under rational basis review, a classification “is accorded a strong presumption of validity.” *Heller v. Doe by Doe*, 509 U.S. 312, 319 (1993). “The firearm regulatory scheme . . . is consonant with the concept of equal protection embodied in the Due Process Clause of the Fifth Amendment if there is some rational basis for the statutory distinctions made . . . or they have some relevance to the purpose for which the classification is made.” *Lewis v. United States*, 445 U.S. 55, 65 (1980) (internal quotation marks omitted).

There is clearly a rational basis for requiring those engaged in the business of manufacturing firearms to be licensed and serialize their firearms. The “principal purpose” of the GCA is to curb crime by keeping “firearms out of the hands of those not legally entitled to possess them.” *Huddleston v. United States*, 415 U.S. 814, 824 (1974) (internal quotation marks omitted). As a result, “[c]ommerce in firearms is channeled through federally licensed importers, manufacturers, and dealers in an attempt to halt mail-order and

interstate consumer traffic in these weapons.” *Id.*; see also *United States v. Biswell*, 406 U.S. 311, 315 (1972) (“[C]lose scrutiny” of “interstate traffic in firearms” is “undeniably of central importance to federal efforts to prevent violent crime and to assist the States in regulating the firearms traffic within their borders.”); *id.* at 315–16 (“Federal regulation” of the traffic in firearms “assures that weapons are distributed through regular channels and in a traceable manner.”); *United States v. Hosford*, 82 F. Supp. 3d 660, 667 (D. Md. 2015) (prohibiting engaging in the business of firearms without a license “ensures that significant commercial traffic in firearms will be conducted only by parties licensed by the federal government”); *id.* (“Nor is the licensing requirement onerous.”); *Marzzarella*, 614 F.3d at 100 (requiring serial numbers not only allows for the “tracing of the chain of custody of firearms involved in crimes,” but also “provides agencies with vital criminology statistics,” “as well as allowing for the identification of individual dealers involved in the trafficking of firearms and the matching of ballistics date with recovered firearms”); *United States v. Adams*, 305 F.3d 30, 34 (1st Cir. 2002) (“[A]nyone can see what Congress was getting at[;]” the serial number is the “principal means of tracing origin and transfers in ownership.”) And, as stated above, public safety and crime prevention are compelling governmental interests.

#### 2. Statutory Authority Concerns

##### a. Lack of Delegated Authority To Promulgate the Rule

#### Comments Received

A majority of commenters opposed to the NPRM argued that ATF is exceeding its authority by promulgating the rule and that it is the job of Congress to change the laws and the job of Federal agencies to enforce them. Because the NPRM explained that the agency is changing its regulations in response to the manner in which courts have ruled on the AR–15-type firearm receiver, commenters stated that it is Congress’s role to amend the law if the law has become out of date and that this power cannot be usurped by a non-legislative governmental entity.

Other commenters argued that ATF’s authority to enact regulations is constrained under 18 U.S.C. 926. They pointed to the Firearms Owners’ Protection Act of 1986 (“FOPA”) and its accompanying legislative history, when Congress amended section 926 by deleting the discretionary language that allowed the Secretary to “prescribe such

rules and regulations as he deems reasonably necessary to carry out the provisions of this chapter.” Commenters stated the prior language was a broader standard and it was amended to the current language, which only allows the Attorney General to “prescribe only such rules and regulations as necessary to carry out the provisions of this chapter.” Further, the commenters stated that none of the examples provided in section 926(a) “indicate[s] any intention of Congress to delegate to the ATF the power to define the items regulated under the GCA . . . in a manner that expands or contracts the scope of the GCA. Rather, [the] examples reinforce Congressional [sic] to severely limit ATF’s authority to those required to carry out the administration of the provisions contained within the GCA.”

Other commenters argued that ATF lacks the authority to act because it is in violation of the non-delegation doctrine, which asks “whether Congress has supplied an intelligible principle to guide the delegatee’s use of discretion.” *Gundy v. United States*, 139 S. Ct. 2116, 2123 (2019). Specifically, they argued that the GCA contains no intelligible principle to guide ATF’s rulemaking authority nor provides any standards for the Department or ATF to redefine statutory definitions. Instead, the commenters asserted, the Attorney General’s rulemaking authority is limited to 18 U.S.C. 926(a). Another commenter wrote that “nothing grants ATF or any other agency the discretion to modify this command” in the GCA that all firearms must bear a serial number although ATF has the ability to provide the practical details of how the marking is to be done. However, the commenter argued the proposed rule grants ATF far too much discretion in deciding which firearms it will regulate and would open “a floodgate of policymaking discretion that the GCA does not and cannot grant to it.” Many other commenters raised specific arguments that ATF’s newly proposed and revised definitions, as well as other proposed marking and recordkeeping requirements on FFLs, are contrary to the GCA. Those separate specific arguments are explained in further detail below. See Sections IV.B.2.b–f of this preamble.

#### Department Response

The Department disagrees that ATF lacks the delegated legal authority to promulgate rules that are necessary to implement the GCA and the NFA, including the definitions of “frame or receiver” promulgated by the predecessor agency to ATF. The

<sup>81</sup> For example, Blackhawk Manufacturing Group objected to the inclusion of its website address, and claimed it was being targeted because “ATF seeks to put [it] out of business.” This is inaccurate. If Blackhawk Manufacturing Group is interested in engaging in the business of manufacturing firearms, it need only apply for a license like other commercial firearms manufacturers.

Department's and ATF's legal authority includes the authority to promulgate regulations and rules implementing and interpreting the GCA and NFA, to specify the information and period by which firearms are required to be marked pursuant to the GCA and NFA, and to specify the precise period and form in which Federal firearm licensee records required by the GCA and NFA are maintained.<sup>82</sup> Congress and the Attorney General have delegated the responsibility for administering and enforcing the GCA and NFA to the Director of ATF, subject to the direction of the Attorney General and the Deputy Attorney General. *See* 26 U.S.C. 7801(a)(2); 28 U.S.C. 599A(b)(1), (c)(1); 28 CFR 0.130(a)(1)–(2); T.D. Order No. 221(2)(a), (d), 37 FR 11696–97 (June 10, 1972). “Because § 926 authorizes the [Attorney General] to promulgate those regulations which are ‘necessary,’ it almost inevitably confers some measure of discretion to determine what regulations are in fact ‘necessary.’”

<sup>82</sup> In this regard, the GCA and NFA include both general and specific delegations of rulemaking authority. *Compare* 18 U.S.C. 926(a) (“The Attorney General may prescribe only such rules and regulations as are necessary to carry out the provisions of this chapter . . . .”); H.R. Rep. No. 90–1577, at 18 (June 21, 1968) (“Section 926. Rules and regulations. This section grants rulemaking authority to the Secretary . . . .”); S. Rep. No. 90–1501, at 39 (Sept. 6, 1968) (same), and 26 U.S.C. 7805(a) (“the [Attorney General] shall prescribe all needful rules and regulations for the enforcement of this title, including all rules and regulations as may be necessary by reason of any alteration of law in relation to internal revenue.”), *with* 18 U.S.C. 921(a)(13) (“The term ‘collector’ means any person who acquires, holds, or disposes of firearms as curios or relics, as the Attorney General shall by regulation define . . . .”); *id.* sec. 923(g)(1)(A) (“Each licensed importer, licensed manufacturer, and licensed dealer shall maintain such records of importation, production, shipment, receipt, sale, or other disposition of firearms at his place of business for such period, and in such form, as the Attorney General may by regulations prescribe.”); *id.* sec. 923(g)(2) (“Each licensed collector shall maintain in a bound volume the nature of which the Attorney General may by regulations prescribe, records of the receipt, sale, or other disposition of firearms.”); *id.* sec. 923(i) (“Licensed importers and licensed manufacturers shall identify by means of a serial number engraved or cast on the receiver or frame of the weapon, in such manner as the Attorney General shall by regulations prescribe, each firearm imported or manufactured by such importer or manufacturer.”); 26 U.S.C. 5841(c) (“Each manufacturer shall notify the Secretary of the manufacture of a firearm in such manner as may be prescribed . . . .”); *id.* sec. 5842(a) (“Each manufacturer and importer and anyone making a firearm shall identify each firearm, other than a destructive device, manufactured, imported, or made by a serial number which may not be readily removed, obliterated, or altered, the name of the manufacturer, importer, or maker, and such other identification as the [Attorney General] may by regulations prescribe.”); and *id.* sec. 5843 (“Importers, manufacturers, and dealers shall keep such records of, and render such returns in relation to, the importation, manufacture, making, receipt, and sale, or other disposition, of firearms as the [Attorney General] may by regulations prescribe.”).

*Nat'l Rifle Ass'n v. Brady*, 914 F.2d 475, 479 (4th Cir. 1990). And courts have long recognized that regulatory agencies do not establish rules to last forever.

“They are neither required nor supposed to regulate the present and the future within the inflexible limits of yesterday.” *Am. Trucking Ass'n v. Atchison, Topeka, and Santa Fe Ry. Co.*, 387 U.S. 397, 416 (1967).

As to comments asserting that the GCA's various delegations of rulemaking authority to the Attorney General and ATF violate the non-delegation doctrine, the Supreme Court has consistently rejected similar arguments with respect to public safety statutes. *See Whitman v. American Trucking Ass'ns*, 531 U.S. 457, 474 (2001) (“[W]e have found an ‘intelligible principle’ in various statutes authorizing regulation in the ‘public interest.’” (collecting cases)). The definitions and requirements established by this rule are all guided by the intelligible principles set forth in the GCA governing the manufacture, importation, dealing, and collecting of firearms, including licensing, marking, recordkeeping, background checks, and crime gun tracing.<sup>83</sup>

#### b. Lack of Authority To Regulate Multiple Parts as “Frames or Receivers” Comments Received

A large number of commenters objected to the proposed definition of “firearm frame or receiver” and, in particular, the supplemental definition of “split or modular frame or receiver.” Commenters stated that the statute is clear that a firearm has only one, singular frame or receiver and that Congress (as ATF pointed out in its NPRM) elected not to regulate all firearms parts when it repealed the FFA and revised the definition of “firearm” in 1968 when passing the GCA. According to these commenters, contrary to the intent of Congress, the NPRM's definition of frame or receiver would return to regulating individual firearm parts by allowing several parts to be considered the frame or receiver.

<sup>83</sup> *Cf. Cargill v. Barr*, 502 F. Supp. 3d 1163, 1188 (W.D. Tex. 2020), *aff'd on other grounds*, 20 F.4th 1004, 1014 (5th Cir. 2021) (“The delegations of authority supporting the Final Rule [defining ‘machinegun’] also do not violate non-delegation principles because 18 U.S.C. 926(a) only permits the Attorney General to ‘prescribe such rules and regulations as are necessary to carry out the provisions of [the GCA]’ and 26 U.S.C. 7805 provides similar authority for ‘all needful rules and regulations for the enforcement of [the NFA].’ 18 U.S.C. 926(a); 26 U.S.C. 7805(a). Given that the Supreme Court has ‘over and over upheld even very broad delegations,’ like ones requiring an agency merely ‘to regulate in the ‘public interest,’” the delegations underlying the Final Rule pass the ‘intelligible principle’ test.”).

Several commenters stated that Congress knew how to distinguish between a whole and parts of a whole. For example, Congress included both the whole and any one of the individual constituent parts in the definition of a silencer or a muffler, which is defined in 18 U.S.C. 921(a)(24) as “any combination or parts . . . and any part intended for use in such assembly or fabrication,” and a “handgun” is defined in 18 U.S.C. 921(a)(29) as “any combination of parts . . . .” If Congress had intended multiple parts of other firearms to be “firearms,” it could have used similar language. Moreover, Congress has amended the GCA several times without redefining the terms at issue.

At least one commenter rejected ATF's reliance on the series of tax cases listed in the NPRM as authority for interpreting statutory definitions to avoid clear error in applying the law. The commenter stated that the Department is not interpreting clear error, but instead is rewriting the law. Some commenters also highlighted *Niz-Chavez v. Garland*, 141 S. Ct. 1474 (2021), a recent Supreme Court case that examined another Federal statute with a singular article before a defined term. In *Niz-Chavez*, the Court evaluated whether an immigration statute's requirement to send “a notice” with certain information was met when the government sent multiple notices, each of which did not contain all of the information required by the statute. The Court applied a plain reading of the text and said the government must send a single notice. *Id.* at 1486. In holding that a singular usage controlled, the Court in *Niz-Chavez* rejected the government's attempt to use the Dictionary Act as a way to pluralize the otherwise singular text of the term, stating “[t]he Dictionary Act does not transform every use of the singular ‘a’ into the plural ‘several.’” *Id.* at 1482.

Many other commenters disagreed with ATF's claim that single frames or receivers were more prevalent for civilian use over split or multi-piece receivers at the time of the GCA's enactment and issuance of the original implementing regulations. One commenter provided copies of historical materials on firearms, including from the Department of Defense, to support his assertion that Members of Congress in 1967, many of whom had served in World War II, would have been personally familiar with “new-fangled” rifles that had an upper and a lower receiver. For this reason, the commenter asserted that it is, therefore, not possible for ATF to argue that Congress did not know there were rifles with upper and



lower receivers when re-defining “firearm” to include “the frame or receiver” instead of “any part or parts of such weapon.” Other commenters also pointed to specific models designed for the military that found their way into common use after World War I, including the 1911 pistol and the Thompson gun.

One commenter, who is a manufacturer, also cited a 1971 Treasury Memorandum on the M16 receiver to show that when ATF was part of the Department of the Treasury, the agency had considered split or multi-piece receiver firearms during the initial rulemaking process but felt it impracticable to do so. The author of the 1971 memorandum stated the “M–16 receiver is fabricated in two parts . . . . Both parts were necessary to function as a ‘frame or receiver . . . .’ I can see some difficulty in trying to make cases against persons possessing only the lower part of the receiver, but insofar as licensing, serial numbering, and special occupational tax requirements are concerned, I feel that [serializing the lower] is the only practical solution.” See CC: ATF–12,736, Subject: M16 Receivers, Internal Revenue Service, Department of the Treasury (March 1, 1971).

#### Department Response

Although the Department disagrees with numerous commenters who claim that the term “frame or receiver” in 18 U.S.C. 921(a)(3)(B) must be read to mean that a firearm may not have more than one frame or receiver, the Department has decided to alter the proposed definition in this final rule in response to comments.<sup>84</sup> The Department agrees with commenters that section 921(a)(3)(B) must be read in context, and recognizes that the Supreme Court in *Niz-Chavez* instructs courts to exhaust all textual and structural clues bearing on the meaning of a statutory term. 141 S. Ct. at 1480. The statutory

term in question is “the frame or receiver of any such weapon” (emphasis added). Unfortunately, here, there are contextual and structural clues that point in different directions. On one hand, “the frame or receiver of any such weapon” refers to a weapon in section 921(a)(3)(A), and that definition uses a singular article when referring to more than one firearm design. For example, section 921(a)(3)(A) states that a “firearm” includes “any weapon . . . which will or is designed to . . . expel a projectile by the action of an explosive” (emphasis added). By using the singular term “a,” Congress clearly did not mean to regulate only those weapons that will or are designed to expel only a single projectile. Almost all firearms are designed to expel more than one projectile after the first, and numerous firearm designs, such as shotguns and machineguns, will expel multiple projectiles at the same time. Moreover, as one commenter pointed out, one major design of a “firearm” under 18 U.S.C. 921(a)(3)(A) is a handgun, and the definition of “handgun” in 18 U.S.C. 921(a)(29)(B) includes “any combination of parts from which a [handgun] can be assembled.”<sup>85</sup> Thus, it is possible that the term “frame,” for example, could be referring to multiple frames within a handgun, or both a frame and a receiver in a split handgun design.<sup>86</sup>

On the other hand, the marking requirement for manufacturers and importers, 18 U.S.C. 923(i), refers to identifying “a” serial number on “the” receiver or frame of the weapon. And the GCA similarly amended the definition of “machinegun” in the NFA at 26 U.S.C. 5845(b) to refer to a singular component when including “the” frame or receiver of any such weapon. The Department agrees with numerous commenters that the context of the singular terms “frame” and “receiver” in these provisions suggests that a firearm only has one frame or receiver. This reading is more consistent with the GCA’s legislative history explaining that Congress found it impractical to treat each small part of a firearm as if it were a weapon capable of firing.<sup>87</sup>

<sup>85</sup> The Department recognizes that “combinations of parts” was added to the definition of “handgun” in the GCA by section 102 of the Brady Handgun Violence Protection Act, Public Law 103–159 (1993).

<sup>86</sup> Cf. *United States v. Morales*, 280 F. Supp. 2d 262, 273 (S.D.N.Y. 2003) (“[T]he different parts represented in Exhibit J to the Becker Affirmation include both the ‘frame’ and the ‘receiver’ of a Tec-9 pistol, and are therefore explicitly covered under the language of 18 U.S.C. 921(a)(3)(B).”).

<sup>87</sup> See *Juvenile Delinquency: Investigation of Juvenile Delinquency in the United States: Hearing before the S. Comm. on the Judiciary*, 88th Cong.

After carefully considering the numerous comments submitted on this issue, the Department agrees that reading the GCA to encompass only one single part of a given weapon would greatly reduce the possibility that a modified weapon might have more than one serial number. Having more than one serial number per firearm would make it more difficult and costly for licensees to mark firearms and maintain associated records, and for law enforcement to trace firearms used in crime. Because the NPRM contemplated the possibility that a given firearm under the proposed rule would have more than one frame or receiver with different serial numbers, the Department is responding to the concerns of those comments by focusing on three subsets of the proposed definition of “frame or receiver.” Specifically, the final rule defines that term to mean a housing or structure for a single fire control component—“frame” for handguns and variants thereof; “receiver” for rifles, shotguns, and projectile weapons other than handguns and variants thereof; and “frame” or “receiver” for firearm muffler or silencer devices.

Finally, to ease the transition to the new definitions and marking requirements, the Department will grandfather existing split frame or receiver designs previously classified by ATF as the firearm “frame or receiver” prior to the issuance of this rule (except for certain partially complete, disassembled, or nonfunctional frames or receivers, to include weapon or frame or receiver parts kits). For example, the lower receiver of the AR–15-type rifle and variants thereof are expressly included within the new definition of “receiver” and may be marked according to the rules that existed before this rule.<sup>88</sup>

(1963) (technical memorandum of Internal Revenue Service) (“The present definition [of “firearm”] includes any ‘part’ of a weapon within the term. It has been found that it is impracticable, if not impossible, to treat all parts of a firearm as if they were a weapon capable of firing. This is particularly true with respect to recordkeeping provisions since small parts are not easily identified by a serial number. Accordingly, there are no objections to modifying the definition so that all parts, other than frames or receivers, are eliminated. It should be noted that this amendment to the definition of ‘firearm’ eliminates all parts of a weapon, other than receivers and frames, from the provisions of the act.”).

<sup>88</sup> However, the Department disagrees with commenters who suggested that the AR–15 rifle was in common civilian (*i.e.*, non-military or law enforcement) use in the United States when ATF’s predecessor agency originally promulgated its regulatory definitions of “frame or receiver” in 1968 (Part 478) and 1971 (Part 479). While millions of AR–15s/M–16s existed at the time ATF promulgated the definitions, the vast majority were

<sup>84</sup> The Dictionary Act recognizes that “[i]n determining the meaning of any Act of Congress, unless the context indicates otherwise, words importing the singular include and apply to several persons, parties, and things.” 1 U.S.C. 1; see also *Niz-Chavez*, 141 S. Ct. at 1482 (the Dictionary Act tells us that a statute using the singular can apply to multiple persons, parties, or things); *Barr v. United States*, 324 U.S. 83, 91 (1945) (citing 1 U.S.C. 1 as authority for construing the statutory term “buying rate” to include more than one buying rate); *Day v. Sec. of Health & Human Services*, 129 Fed. Cl. 450, 452 (2016) (“The mere use of terms in the singular, of course, hardly provides the context for escaping the ambit of the Dictionary Act rule regarding the use of the singular.”); *Georgetown Univ. Hospital v. Sullivan*, 934 F.2d 1280, 1283–84 (D.D.C. 1991) (use of definite article “the” with the singular word “amount” did not preclude the possibility there may be more than one “amount”).

### c. Lack of Authority To Regulate Weapon Parts Kits

#### Comments Received

Commenters opposed to the NPRM specifically argued that ATF did not have the authority to amend the regulatory definition of “firearm” to include weapon parts kits because it runs contrary to the GCA’s definition of firearm. Commenters stated that the definition of “firearm” cannot be read, and has not been read in the cases cited by ATF, to include a kit containing parts that could be used to make a weapon because a kit is not itself a weapon. They stated that section 921(a)(3)(A) is clear that a firearm is a “weapon that can be readily converted to expel . . . , not the parts that can readily be converted to expel a projectile.” Further, commenters argued that including weapon parts kits would impermissibly expand and alter the statutory meaning of both “converted” and “readily.” They stated that ATF cannot equate “converted” with the proposed added words “assembled,” “completed,” or “restored,” and that, under a plain English reading, one would not “convert” these parts into a weapon. The GCA uses a starter gun as an example of an existing item that can be converted. Even assuming the definition includes “assembled,” the commenter stated that “[a] weapon parts kit that does not contain most of the necessary components, or that needs machining, cannot be assembled (or converted) ‘readily’ i.e., ‘without much difficulty’ or ‘with fairly quick efficiency.’”

#### Department Response

The Department disagrees with commenters and believes the language of section 921(a)(3)(A) should be read to include weapon parts kits and aggregations of weapon parts that: (1) Are actually designed to expel a projectile by the action of an explosive in their present form or configuration, but cannot expel a projectile due to damage, poor workmanship, or design flaw or feature regardless of whether they may readily be made to function; or (2) may or may not be designed to expel a projectile by the action of an explosive in their present form or configuration, but may readily be converted to do so. The Federal courts that have addressed this issue have uniformly held that disassembled

aggregations of weapon parts<sup>89</sup> and weapon parts kits<sup>90</sup> that may readily be converted to expel a projectile are “firearms” under 18 U.S.C. 921(a)(3)(A).

A “weapon” is defined by common dictionaries as “[a]n instrument of offensive or defensive combat,” see Webster’s Third New International Dictionary 2589 (2002), but there is no requirement in either the dictionary definition or section 921(a)(3)(A) that the instrument have a minimum level of utility or lethality to be considered a “weapon.”<sup>91</sup> While the aggregation of parts in a kit may not yet function as a weapon, these parts, simply in broken down form, can only be completed and assembled as instruments that expel live ammunition. Weapons completed from the parts in these kits typically incorporate or accept magazines that hold multiple rounds of lethal ammunition. They are not ornaments,<sup>92</sup> toys,<sup>93</sup> or industrial tools.<sup>94</sup> Requiring

<sup>89</sup> See, e.g., *United States v. Annis*, 446 F.3d 852, 857 (8th Cir. 2006) (partially disassembled rifle that could easily be made operational was a firearm under section 921(a)(3)(A)); *United States v. Ryles*, 988 F.2d 13, 16 (5th Cir. 1993) (disassembled shotgun was a firearm because it could have been readily converted to an operable firearm); *United States v. Theodoropoulos*, 866 F.2d 587, 595 n.3 (3d Cir. 1989) (machine pistol that was disassembled that could easily be made operable); *Enamorado v. United States*, No. C16–30290–MWB, 2017 WL 2588428, at \*6 (N.D. Iowa June 14, 2017) (disassembled .45 caliber handgun that could easily be reassembled); *United States v. Morales*, 280 F. Supp. 2d 262, 272–73 (S.D.N.Y. 2003) (partially disassembled Tec-9 pistol that could be assembled within short period of time could readily be converted to expel a projectile); *United States v. Randolph*, No. 02 CR. 850–01 (RWS), 2003 WL 1461610, at \*2 (S.D.N.Y. Mar. 20, 2003) (gun consisting of “disassembled parts with no ammunition, no magazine, and a broken firing pin, making it incapable of being fired without replacement or repair” was a “firearm” because it could be readily converted to expel a projectile and included the frame or receiver of any such weapon).

<sup>90</sup> See, e.g., *United States v. Wick*, 697 F. App’x 507, 508 (9th Cir. 2017) (complete Uzi parts kits “could” readily be converted to expel a projectile by the action of an explosive, thus meeting the statute’s definition of firearm” because the “kits contained all of the necessary components to assemble a fully functioning firearm with relative ease”); *United States v. Stewart*, 451 F.3d 1071, 1073 n.2 (9th Cir. 2006) (upholding district court’s finding that .50 caliber rifle kits with incomplete receivers were “firearms” under section 921(a)(3)(A) because they could easily be converted to expel a projectile).

<sup>91</sup> See *Bond v. U.S.*, 572 U.S. 844, 861 (2014) (citing dictionary definitions, and concluding that non-lethal irritant chemical was not a weapon).

<sup>92</sup> See, e.g., *United States v. Wada*, 323 F. Supp. 2d 1079, 1081 (D. Or. 2004) (ornaments that “would take a great deal of time, expertise, equipment, and materials to attempt to reactivate” were no longer firearms).

<sup>93</sup> See, e.g., *Lunde Arms Corp. v. Stanford*, 107 F. Supp. 450, 452 (S.D. Cal. 1952), *aff’d*, 211 F.2d 464 (9th Cir. 1954) (small muzzle loading toy cap gun that expelled non-lethal bird shot was not a “weapon”); *Rev. Rul. 54–519*, 1954–2 C.B. 438 (inexpensive plastic toy gun was not a “weapon”).

<sup>94</sup> See H.R. Rep. No. 90–1577, at 10 (June 21, 1968) (“[P]owder actuated industrial tools used for

some minimum level of utility, lethality, or actual functionality for aggregations of parts that are clearly identifiable as unassembled, unfinished, or incomplete pistols, revolvers, rifles, or shotguns, would be reading a requirement into the statutory definition of “firearm” that is not present. So long as the aggregation of parts is clearly identifiable as an instrument to expel live ammunition (including a starter gun), that is sufficient under section 921(a)(3)(A) to constitute a “weapon.”<sup>95</sup> Indeed, numerous courts have recognized that an item was a rifle, shotgun, pistol, or revolver—a weapon—even though it was unassembled or nonfunctional due to missing or broken components.<sup>96</sup>

The Department agrees with commenters that the term “weapon which . . . may readily be converted to” was inserted into the definition of “firearm” in the GCA to include, as an example, starter guns designed for use with blank ammunition.<sup>97</sup> However, the legislative history indicates that Congress included these guns because the convertibility of these starter pistols was found to be a matter of serious concern to law enforcement. One example of these conversions cited in the legislative history of the GCA was a “do-it-yourself gunsmith” who made out-of-State bulk purchases of starter pistols. “[H]e would then, at his residence, disassemble them, and using an electric hand drill mounted in a drill press stand, bore out the plugged barrel and enlarge the cylinder chambers to accommodate .22-caliber cartridges.”<sup>98</sup>

their intended purpose are not considered weapons and, therefore, are not included in this definition.”); S. Rep. No. 90–1097, at 111 (April 29, 1968) (same).

<sup>95</sup> Cf. *United States v. Thompson/Center Arms*, 504 U.S. 505, 513, n.6 (1992) (finding that a rifle—a type of weapon—was “made” under the NFA when a pistol was packaged together with a disassembled rifle parts kit even in the absence of “combination of parts” language); *United States v. Hunter*, 843 F. Supp. 235, 256 (E.D. Mich. 1994) (“If Defendants believe that conversion kits are not in and of themselves ‘weapons’ under § 921(a)(3), they forget that that section clearly envisions machineguns as weapons.”); *United States v. Drasen*, 845 F.2d 731, 736–37 (7th Cir. 1988) (rejecting argument that a collection of rifle parts cannot be a “weapon” even in the absence of combination of parts language); *United States v. Grimm*, 51 M.J. 254, 254 (C.A.A.F. 1999) (disassembled pistol with various components carried in different pants pockets was a “weapon”).

<sup>96</sup> See footnotes 42 and 43, *supra*.

<sup>97</sup> See S. Rep. No. 89–1866, at 14, 73 (Oct. 19, 1966) (“Added to the term ‘firearm’ are weapons which ‘may be readily converted to’ a firearm. The purpose of this addition is to include specifically any starter gun designed for use with blank ammunition which will or which may be readily converted to expel a projectile or projectiles by the action of an explosive.”).

<sup>98</sup> See S. Rep. No. 88–1340, at 14 (Aug. 7, 1967). The completed weapons were reassembled, packaged as a kit with a holster and a box of fifty

manufactured for military use. See Internal Colt Memorandum from B. Northrop, Feb. 2, 1973, p. 2 (noting that there were 2,752,812 military versus 25,774 civilian (“Sportsmen”) serialization of AR–15/M–16 rifles then manufactured).

The focus on starter pistols is not on starter pistols themselves as a weapon, but on their ability to be converted to a functional state. As such, the Department sees no legal distinction under the GCA between starter guns that may readily be converted to fire, and pistols, revolvers, rifles, or shotguns parts kits that may readily be converted to fire. All are incomplete “weapons” that may readily be converted to fire under the GCA.

Determining *when* a weapon configured as a parts kit meets the statutory definition of “firearm” requires a case-by-case evaluation of each kit. Some weapon parts kits are “firearms” because they are *designed to* expel a bullet, even if they cannot presently fire or readily be made to function because of damage, poor workmanship, or design flaw or feature.<sup>99</sup> Such weapon parts kits are akin to “unserviceable firearms,” defined by the GCA as “a *firearm* which is incapable of discharging a shot by means of an explosive and incapable of being *readily restored* to a firing condition” (emphases added).<sup>100</sup> Some weapon parts kits are “firearms” because they *may readily be converted* to expel a bullet, even if they cannot yet expel one or function without additional work.

The Department disagrees with the comment that weapon parts kits must contain all component parts of the weapon to be “readily” converted to expel a projectile. But the Department agrees that the completeness of the kit is an important factor in determining whether a weapon parts kit may readily be converted to expel a projectile. This is why one of the factors in the definition of “readily” that courts have relied upon in determining whether a weapon may “readily be restored” to fire is whether additional parts are required, and how easily they may be obtained. An essential part missing from the kit that cannot efficiently, quickly, and easily be obtained would mean that

.22-caliber cartridges, and sold to youth gang members.

<sup>99</sup>The common meaning of the term “design” is “to conceive and plan out in the mind” or “to plan or have in mind as a purpose.” See *United States v. Gravel*, 645 F.3d 549, 551 (2d Cir. 2011) (quoting Webster’s Third Int’l Dictionary (1993)).

<sup>100</sup>Section 201 of Public Law 90–618 (Title II); 26 U.S.C. 5845(h); 27 CFR 478.11, 479.11 (definition of “unserviceable firearm”); H.R. Rep. No. 90–1577, at 10 (June 21, 1968) (“This provision makes it clear that so-called unserviceable firearms come within the definition.”); S. Rep. No. 90–1097, at 111 (April 29, 1968) (same). The GCA allows an unserviceable curio or relic firearm other than a machinegun to be imported. 18 U.S.C. 925(d)(2). Unserviceable NFA firearms may also be transferred as a curio or ornament without payment of the transfer tax. 26 U.S.C. 5852(e).

the weapon cannot readily be completed, assembled, restored, or otherwise “converted” to a functional state.<sup>101</sup>

#### d. Lack of Authority To Regulate ‘Partially Complete’ Frames or Receivers

##### Comments Received

Commenters argued that ATF does not have authority to regulate “partially complete frames or receivers” because section 921(a)(3)(B) is clear that a completed frame or receiver is not a weapon, but only a part of such a weapon. Their theory is that if a frame or receiver were equivalent to a weapon, then section 921(a)(3)(B) would be read as “the weapon of any such weapon” rather than “the frame or receiver of any such weapon.” Further, commenters stated that ATF does not have authority to apply the phrase “may readily be converted” to define “partially complete . . . frame or receiver” since the “may readily be converted” language was included in prong (A) of section 921(a)(3) (applying to weapons) but not prong (B), meaning that “readily” cannot be applied to “frame or receiver” to allow for the inclusion of partially complete frames or receivers in the regulatory scheme.

##### Department Response

The Department agrees with commenters who stated that frames or receivers are not “weapons.” They are the frames or receivers “*of*” the weapons described in 18 U.S.C. 921(a)(3)(A), and they are regulated as “firearms” with or without the component parts necessary to produce complete weapons. 18 U.S.C. 921(a)(3)(B). But Congress did not define the term “frame or receiver” in 18 U.S.C. 921(a)(3)(B), and the crucial inquiry is at what point an unregulated piece of metal, plastic, or other material becomes a “frame or receiver” that is a regulated item under Federal law. ATF has long held that a piece of metal, plastic, or other material becomes a frame or receiver when it has reached a “critical stage of manufacture.” To make this determination, ATF’s position has been that the item has reached a “critical stage of manufacture” when it is “brought to a stage of completeness that will allow it to accept the firearm components to which it is designed for [sic], using basic tools in a reasonable

<sup>101</sup>As explained in the next section, the Department also disagrees that the terms “assembled” and “completed” cannot be equated with “conversion” because that latter term means, in the context of manufacturing, altering raw materials to make them suitable for use. See footnote 104, *infra*.

amount of time.”<sup>102</sup> Accordingly, this rule explains that the terms “frame” and “receiver” include a partially complete frame or receiver “that is designed to, or may readily be completed, assembled, restored, or otherwise converted” to accept the parts it is intended to house or hold.

The Department disagrees with commenters’ suggestion that the Department cannot use the concepts of “readily” and “converted” in describing partially complete frames and receivers simply because those terms appear in section 921(a)(3)(A). In crafting the language of the regulation, ATF has properly considered concepts concerning when other firearms reach the point at which they are regulated under Federal law.<sup>103</sup> This analysis is also appropriate because the very definition of “manufacturing” is the process of “converting” raw materials into finished goods suitable for use.<sup>104</sup>

<sup>102</sup>See ATF Letter to Private Counsel #303304, at 3–4 (Mar. 20, 2015) (internal quotation marks omitted); ATF Rul. 2015–1 (an AR-type lower receiver that has been indexed may be classified as a receiver even though additional machining or other manufacturing process takes place to remove material from the cavity that allows the fire control components to be installed).

<sup>103</sup>See footnotes 43 and 44, *supra*; see also 18 U.S.C. 921(a)(3)(A); 26 U.S.C. 5845(b).

<sup>104</sup>See Merriam-Webster.com, available at <https://www.merriam-webster.com/dictionary/convert> (last visited Mar. 24, 2022) (The term “convert” means “to alter the physical or chemical nature or properties of especially in manufacturing.”); *Samsung Electronics Co., Ltd. v. Apple Inc.*, 137 S. Ct. 429, 435 (2016) (“‘manufacture’ means ‘the conversion of raw materials by the hand, or by machinery, into articles suitable for the use of man’ and ‘the articles so made.’” (citing J. Stormonth, *A Dictionary of the English Language* at 589 (1885))); *FastShip, LLC v. United States*, 892 F.3d 1298, 1303 n.7 (Fed. Cir. 2018) (same); *Cyrix Corp. v. Intel Corp.*, 803 F. Supp. 1200, 1206 (E.D. Tex. 1992) (referring to the manufacturing process of converting raw materials into computer coprocessors); *Swiss Manufacturers Ass’n, Inc. v. United States*, 39 Cust. Ct. 227, 233 (1957) (“What must be kept in mind is the distinction between manufacturing operations which advance the materials as materials and manufacturing operations which convert the materials into the complete articles.”); *Dean & Sherk Co., Inc. v. United States*, 28 Cust. Ct. 186, 189 (1952) (“It may require more than one manufacturing process to convert a textile material into a new textile material having a new name, character, or use.”); *United States v. J.A. Schneider & Co.*, 21 C.C.P.A. 352, 357 (Cust. & Pat. App. 1934) (referring to the process of taking finished products of certain processes of manufacture as “material for subsequent manufacturing processes necessary to convert them into parts for furniture”); *Bedford Mills v. United States*, 75 Ct. Cl. 412, 423 (1932) (referring to a “manufacturer” as “one who converts raw materials into a finished product”); *Stonoco, Inc. v. Limbach*, 53 Ohio St. 3d 170, 173, 560 N.E. 2d 578, 580 (Ohio. 1990) (“manufacturing is the commercial use of engines, machinery, tools, and implements to convert material into a new form, quality, property, or combination and into a more valuable commodity for sale”); *State v. American Sugar Refining Co.*, 108 La. 603, 627, 32 So. 965, 974 (La.

While this analysis is intended to capture when an item becomes a frame or receiver that is regulated irrespective of the type of technology used, unformed blocks of metal, liquid polymers, and other raw materials only in a primordial state would not be considered by this rule to be a frame or receiver. However, when a frame or receiver is broken, disassembled into pieces, or is a forging, casting, or additive printing for a frame or receiver (*i.e.*, a partially complete frame or receiver) that has reached a stage of manufacture where it can readily be completed, assembled, restored, or otherwise converted into a functional frame or receiver, that article is a “frame or receiver” under the GCA.<sup>105</sup>

In light of the widespread availability of unlicensed and unregulated partially complete or unassembled frames or receivers, which are often sold as part of easy-to-complete kits, it is necessary to deter prohibited persons from obtaining or producing firearms by clarifying that incomplete frames or receivers can be firearms within the meaning of the governing law.<sup>106</sup>

1902) (“The process of manufacture converts the raw material . . . into the manufactured articles”); *see also* Prod. Liab.: Design and Mfg. Defects § 14:7 (2d ed.) (“The basic function of the manufacturing organization is to convert raw materials into finished products.”); *cf. Broughman v. Carver*, 624 F.3d 670, 675 (4th Cir. 2010) (to “manufacture” a firearm means “to render the firearm ‘suitable for use’”).

<sup>105</sup> *See* S. Rep. No. 90–1501, at 46 (Sept. 6, 1968) (“Of course, if the frame or receiver are themselves unserviceable as a frame or receiver then they would be treated as an unserviceable machinegun. Any machinegun frame or receiver which is readily restorable would be treated as serviceable.”); *United States v. Thomas*, No. 17–194 (RDM), 2019 WL 4095569, at \*5 (D.D.C. Aug. 29, 2019) (In holding that a revolver missing its trigger, hammer, and cylinder pin was a “frame or receiver” under section 921(a)(3)(B), the Court stated that “Thomas’s theory also twists the statutory definition beyond comprehension: Under his theory, Congress included the ‘frame or receiver’ of a weapon—which is, by definition, inoperable—in the statutory definition, but did so only for those frames or receivers that are part of an operable weapon. The Court rejects this mind-bending reading of the statute.”).

<sup>106</sup> The Polymer 80 assembly, for example, may be completed in under thirty minutes. *See, e.g.*, Silverback Reviews, *POLYMER 80 Lower completion/Parts kit install*, YouTube (Aug. 19, 2019), available at <https://web.archive.org/web/20200331211935/https://www.youtube.com/watch?v=ThzFOIYZgIq> (21-minute video of completion of a Polymer 80 lower parts kit with no slide) (last visited Apr. 1, 2022). Indeed, the internet is replete with “numerous videos that provide explicit instructions on how to construct ghost guns.” Letter for Susan Wojcicki, CEO, YouTube, from Senators Blumenthal, Menendez, Murphy, Booker, and Markey at 1 (Feb. 14, 2022), available at <https://www.blumenthal.senate.gov/imo/media/doc/0215.22youtubeghostguns.pdf> (last visited Apr. 1, 2022); Joshua Eaton, *Senators call on YouTube to crack down on ‘ghost gun’ videos*, NBCNews.com (Feb. 15, 2022), available at [Otherwise, persons could easily circumvent the requirements of the GCA and NFA, including licensing, marking, recordkeeping, and background checks \(and, if a machinegun, NFA registration\) simply by producing almost-complete frames or receivers, or by making a few minor alterations to existing frames or receivers that could quickly be altered to produce either a functional weapon, or a functional frame or receiver of any such weapon. To be sure, many prohibited persons have easily obtained them.<sup>107</sup> A contrary rule, under which](https://www.nbcnews.com/news/us-news/senators-</a></p>
</div>
<div data-bbox=)

[youtube-ghost-gun-videos-rcna16387](https://www.youtube.com/watch?v=rcna16387) (last visited Apr. 1, 2022); Joshua Eaton, *YouTube banned ‘ghost gun’ videos. They’re still up.*, NBCNews.com (Dec. 9, 2021), available at <https://www.nbcnews.com/news/us-news/youtube-ghost-gun-videos-rcna7605> (last visited Apr. 1, 2022).

<sup>107</sup> *See* footnote 20, *supra*; *see also* *Convicted Felon Nabbed in Lakeside with Meth, Ghost Guns and Burglary Tools*, *timesofsandiego.com* (Jan. 29, 2022), available at <https://timesofsandiego.com/crime/2022/01/29/convicted-felon-nabbed-in-lakeside-with-meth-ghost-guns-and-burglary-tools/> (last visited Mar. 24, 2022); Kym Kemp, *Felon found with ‘ghost gun’ arrested, says HCSO*, *kymkemp.com* (Nov. 29, 2021), available at <https://kymkemp.com/2021/11/29/felon-found-with-ghost-gun-arrested-says-hcso/> (last visited Mar. 24, 2022); Det. Patrick Michaud, *Georgetown Arrest of a Felon Leads to Recovery of Ghost Gun*, *spdblotter.seattle.gov* (Nov. 8, 2021), available at <https://spdblotter.seattle.gov/2021/11/08/georgetown-arrest-of-a-felon-leads-to-recovery-of-ghost-gun/> (last visited Mar. 24, 2022); *Deputy recovers ‘ghost gun’ from convicted felon during traffic stop*, *fontanaheraldnews.com* (Aug. 10, 2021), available at [https://www.fontanaheraldnews.com/news/inland\\_empire\\_news/deputy-recovers-ghost-gun-from-convicted-felon-during-traffic-stop/article\\_3cfe0fd0-f4a3-11eb-bd31-03979dc83307.html](https://www.fontanaheraldnews.com/news/inland_empire_news/deputy-recovers-ghost-gun-from-convicted-felon-during-traffic-stop/article_3cfe0fd0-f4a3-11eb-bd31-03979dc83307.html) (last visited Mar. 24, 2022); *Lehigh Valley felon was using 3D printer to make ‘ghost guns’ at home, Pa. attorney general says*, *lehighvalleylive.com* (Jun. 29, 2021), available at <https://www.lehighvalleylive.com/northampton-county/2021/06/lehigh-valley-felon-was-using-3d-printer-to-make-ghost-guns-at-home-pa-attorney-general-says.html> (last visited Mar. 24, 2022); Press Release, Department of Justice, U.S. Attorney’s Office, District of Conn., *Bridgeport Felon Sentenced to More Than 5 Years in Federal Prison for Possessing Firearms* (Jan. 7, 2021), <https://www.justice.gov/usao-ct/pr/bridgeport-felon-sentenced-more-5-years-federal-prison-possessing-firearms>; Christopher Gavin, *Winthrop man had homemade ‘ghost’ guns and 3,000 rounds of ammunition, prosecutors say*, *Boston.com* (Aug. 5, 2020), available at <https://www.boston.com/news/crime/2020/08/05/winthrop-man-had-homemade-ghost-guns-prosecutors-say> (last visited Mar. 24, 2022); *‘Ghost Gun’ used in shooting that killed two outside Snyder County restaurant*, *pennlive.com* (Jul. 14, 2020), available at <https://www.pennlive.com/crime/2020/07/ghost-gun-used-in-shooting-that-killed-two-outside-snyder-county-restaurant.html> (last visited Mar. 24, 2022); *The gunman in the Saugus High School shooting used a ‘ghost gun,’ sheriff says*, *CNN.com* (Nov. 21, 2019), available at <https://www.cnn.com/2019/11/21/us/saugus-shooting-ghost-gun/index.html> (last visited Mar. 24, 2022); *How the felon killed at Walmart got his handgun, DA says*, *LehighValleyLive.com* (March 9, 2018), available at [https://www.lehighvalleylive.com/news/2018/05/how\\_the\\_felon\\_killed\\_at\\_walmar.html](https://www.lehighvalleylive.com/news/2018/05/how_the_felon_killed_at_walmar.html) (last visited Mar. 24, 2022); *‘Ghost guns’: Loophole allows felons to legally buy gun parts online*, *KIRO7.com* (Feb. 22, 2018), available at <https://www.kiro7.com/news/>

prohibited persons can easily make or acquire virtually untraceable firearms directly from unlicensed parts manufacturers, would unreasonably thwart Congress’s evident purpose in the GCA and the NFA.<sup>108</sup> These principles provide further reason not to read into the definition of “frame or receiver” terms like “finished,” “operable,” “functional,” or a minimum percentage of completeness (*e.g.*, “80.1%”).

#### e. Lack of Authority To Regulate “Privately Made Firearms”

##### Comments Received

Commenters also generally stated that Congress did not grant any statutory authority to ATF to regulate PMFs. They explained that the GCA’s central premise has been based on Congress’s authority to regulate interstate commerce and that Congress has gone to great lengths to clarify that only those involved in commercial manufacturing are subject to the GCA. A private party, making a firearm for their own use, has never been subject to regulation. The commenter cited section 101 of the GCA, which provides that “it is not the purpose of this title to place any undue or unnecessary Federal restrictions or burdens on law-abiding citizens with the respect to the acquisition, possession, or use of firearms,” and that the “title is not intended to discourage the private ownership or use of firearms by law-abiding citizens.” Commenters argue that because these PMFs are made solely for personal use, they do not come under the legal purview of the NFA or GCA as they lack any substantial connection to interstate commerce and therefore ATF is without statutory authority to make any rule pertaining to PMFs.

##### Department Response

The Department agrees that firearms privately made by non-prohibited persons solely for personal use generally do not come under the purview of the GCA.<sup>109</sup> This rule does not restrict law-

[local/ghost-guns-federal-loophole-allows-felons-to-legally-buy-gun-parts-online-build-assault-weapons/703695149/](https://www.localghostguns.com/news/federal-loophole-allows-felons-to-legally-buy-gun-parts-online-build-assault-weapons/703695149/) (last visited Mar. 24, 2022).

<sup>108</sup> *See* *New York v. Burger*, 482 U.S. 691, 713 (1987) (“[T]he regulatory goals of the Gun Control Act . . . ensure[] that weapons [are] distributed through regular channels and in a traceable manner” thus making “possible the prevention of sales to undesirable customers and the detection of the origin of particular firearms.”) (quoting *United States v. Biswell*, 406 U.S. 311, 315–16 (1972)); *City of Chicago v. U.S. Dep’t of Treasury, Bureau of Alcohol, Tobacco & Firearms*, 423 F.3d 777, 781 (7th Cir. 2005) (statutes should not be read in a way that “would thwart Congress’ intention”).

<sup>109</sup> However, the Undetectable Firearms Act of 1988, *see* 18 U.S.C. 922(p), which amended the GCA, prohibits the manufacture and possession of

abiding citizens' ability to make their own firearms from parts for self-defense or other lawful purposes. Under this rule, non-prohibited persons may continue to lawfully complete, assemble, and transfer unmarked firearms without a license as long as they are not engaged in the business of manufacturing, importing, dealing in, or transacting curio or relic firearms in a manner requiring a license. *See* 18 U.S.C. 922(a)(1), 923(a), (b). Neither the GCA nor this implementing rule requires unlicensed individuals to mark (non-NFA) firearms they make for their personal use, or to transfer them to an FFL for marking. Such individuals who wish to produce, acquire, or transfer PMFs should, however, determine whether there are any applicable restrictions under State or local law.<sup>110</sup>

The Department disagrees with comments stating that ATF does not have the authority to regulate PMFs when those firearms are received and transferred by FFLs like other firearms subject to regulation under the GCA. The GCA provides that all firearms received and transferred by FFLs must be traceable through licensee records maintained for the period and in such form as prescribed by regulations. 18 U.S.C. 923(g)(1)(A), (g)(2). There is no exception for PMFs.

#### f. Lack of Authority To Require FFLs To Mark Serial Numbers on "Privately Made Firearms"

##### Comments Received

Several commenters stated that ATF lacks the statutory authority to require FFL dealers to engrave serial numbers on PMFs. Commenters argued that section 923(i) of the GCA only requires that "licensed importers and licensed manufacturers" mark firearms. They pointed out that while numerous provisions apply to importers, manufacturers, dealers, and collectors, not all do. For example, licensed collectors are not required to maintain records of importation as they are not listed in the statute. Accordingly, the commenters argued that Congress expressly imposed the duty to engrave serial numbers only on licensed importers and manufacturers but not on licensed dealers and that ATF is without any statutory basis to require any other FFLs, such as retailers, to mark firearms. Further, commenters argued that while the GCA requires a firearm have "a serial number engraved or cast on the receiver or the frame of

the weapon," this does not provide authority for ATF to require placement of multiple serial numbers or a single serial number on multiple parts.

##### Department Response

The Department disagrees that, under the GCA, licensees other than licensed manufacturers and importers cannot be required to mark firearms. The Attorney General and ATF have authority to promulgate regulations necessary to enforce the provisions of the GCA, and requiring licensees to mark PMFs is such a regulation. *See* 18 U.S.C. 926(a); H.R. Rep. No. 90-1577, at 18 (June 21, 1968); S. Rep. No. 90-1501, at 39 (Sept. 6, 1968). "Because § 926 authorizes the [Attorney General] to promulgate those regulations which are 'necessary,' it almost inevitably confers some measure of discretion to determine what regulations are in fact 'necessary.'" *Nat'l Rifle Ass'n v. Brady*, 914 F.2d 475, 479 (4th Cir. 1990). "[T]he regulatory goals of the Gun Control Act . . . ensure[] that weapons [are] distributed through regular channels and in a traceable manner," thus making "possible the prevention of sales to undesirable customers and the detection of the origin of particular firearms.'" *New York v. Burger*, 482 U.S. 691, 713 (1987) (quoting *United States v. Biswell*, 406 U.S. 311, 315-16 (1972)). "Severely limiting the application of the GCA's 'manufacturing' provisions would be inconsistent with these goals and would serve to 'undermine the congressional policies' underlying the Act." *Broughman v. Carver*, 624 F.3d 670, 677 (4th Cir. 2010).

In enacting the GCA, which amended the NFA, Congress clearly understood that persons other than licensed manufacturers and importers may need to mark firearms they make or possess privately with a serial number and other identifying information. *See, e.g.*, 26 U.S.C. 5842(a)-(b) (requiring unlicensed makers and possessors to place serial numbers and other marks of identification on NFA firearms as may be prescribed by regulations).<sup>111</sup> The GCA requires licensees to record firearm information for purposes of tracing. Yet licensees have no serial number or other identifying information marked on the frame or receiver of a privately made (non-NFA) firearm that they can record in cases where a licensed manufacturer does not produce the firearm or an importer does not import the firearm,

unless they are able to mark such firearms when received into inventory. Under 18 U.S.C. 923(i), licensed importers and manufacturers are required to mark firearms, but it does not prohibit others from also doing so. The GCA's silence on the specific manner in which licensees are to mark the firearms that they receive into inventory cannot be construed as a prohibition against any marking requirement through regulation.

This rule is necessary to ensure the continuing fulfillment of the congressional intent to mark and allow for tracing of all firearms. If licensees accept PMFs into their inventories with no identifying markings, then the required records they maintain would be rendered meaningless because there would be almost no information—only the "type" of firearm—recorded in the A&D records, ATF Forms 4473, Theft/Loss Reports, and Reports of Multiple Sales. The information in these records is essential to public safety in that they are used to trace firearms involved in a crime and to prevent straw purchasers from acquiring them. There would be little point inspecting the records of FFLs that do not contain serial numbers, which are critical to solving and preventing crime.

In this regard, 18 U.S.C. 923(g)(1)(A) and (g)(2) specifically authorize ATF to prescribe regulations with respect to the records regarding importation, production, shipment, receipt, sale, or other disposition of firearms. By regulation, a firearm's serial number and other identifying information are required to be entered on all Forms 4473, A&D records, and ATF Forms 6/6A import permit applications. *See* 27 CFR 478.112(b)(1)(iv)(G), 478.113(b)(1)(iv)(G), 478.114(a)(1)(v)(G), 478.122(a)-(b), 478.123(a)-(b), 478.124(c)(4), 478.125(e), 478.125a(a)(4). Licensees are also required to submit theft/loss reports and ATF Forms 3310.11 (pursuant to 18 U.S.C. 923(g)(6)), and multiple sales and demand letter transaction reports, ATF Forms 3310.4, 3310.12, and 5300.5 (pursuant to 18 U.S.C. 923(g)(3)(A) and (g)(5)(A)), all of which require reporting of the serial number and other identifying information. As explained in this rule, these records and reports are largely meaningless without a unique identifying number and associated licensee information. Therefore, in order for licensees to comply with recording and reporting this information as required, it is incumbent on them to serialize—or cause to be serialized—all firearms that are taken into their inventories.

any firearm that is not as detectable as the "Security Exemplar" that contains 3.7 ounces of material type 17-4 PH stainless steel.

<sup>110</sup> *See* footnote 24, *supra*; 18 U.S.C. 927.

<sup>111</sup> The Department also notes that 18 U.S.C. 922(k), which prohibits possession of a firearm with the "importer's or manufacturer's serial number" removed, obliterated, or altered, does not necessarily refer to the serial number placed by a licensed importer or a licensed manufacturer.

At the time the GCA was enacted, almost all firearms were commercially produced by manufacturers (either within or outside the U.S.) because the milling equipment, materials needed, and designs were far too expensive for individuals to make firearms practically or reliably on their own. But today, firearms may be made at home from commercially produced parts kits by purchasing individual parts or using personally owned or leased equipment, including 3D printers. Also, cheaper materials, such as polymer plastics, along with blueprints and instructions, are now readily available over the internet. When Congress enacted the GCA, it likely did not consider that unmarked PMFs would enter the business or collection inventories of licensees, at least not in any significant number. “But whatever the reason, the scarcity of controls in the secondary market provides no reason to gut the robust measures Congress enacted at the point of sale.” *Abramski v. United States*, 573 U.S. 169, 187 (2014).

Further, the rule necessarily allows licensed firearms dealers, including gunsmiths, to mark PMFs because licensed manufacturers and importers may refuse to provide these services as they are generally focused on their own production or importation of firearms. Without this change, the availability of professional marking by dealer-gunsmiths would be greatly limited and the efficacy of the rule would also be reduced if unlicensed individuals had fewer options to have their PMFs professionally marked. Moreover, allowing licensed firearms dealers, or licensed or unlicensed persons under the direct supervision of licensed firearms dealers, to properly mark firearms in a manner that ATF can trace directly to them reduces the tracing burden on manufacturers and importers, as well as law enforcement. It also provides dealers with the opportunity to earn additional income from repairing, customizing, or pawning firearms that are privately made—firearms that are highly likely to proliferate throughout the marketplace over time as firearms production technology develops. Licensed dealer-gunsmiths, in particular, are well-equipped to provide these services as they routinely engage in the business of engraving, painting, camouflaging, or otherwise customizing firearms for unlicensed individuals.<sup>112</sup>

<sup>112</sup> See ATF Rul. 2009–1. While this ruling explains that gunsmiths who engage in the business of camouflaging or engraving firearms must be licensed as dealers, that ruling is superseded by this rule to the extent that those processes are performed on firearms “for purposes of sale or distribution,” requiring a license as a manufacturer. See 18 U.S.C.

Finally, the Department agrees with comments saying that the placement of multiple serial numbers on multiple frames or receivers of PMFs would be burdensome and costly for licensees, and would make it more difficult for law enforcement to trace firearms, including PMFs. For this reason, ATF is finalizing this rule to require placement of an individual serial number on a single frame or receiver of a given firearm. This does not mean, however, that it is impossible for a firearm to have more than one serial number marked on the frame or receiver. For example, a remanufacturer or importer who does not adopt an existing serial number as expressly allowed under this rule may re-mark the firearm with their own unique serial number. This has always been the case under current regulations. Additionally, multi-piece frames or receivers as defined in this rule may have the serial number marked on different sides of the same frame or receiver. The Department nonetheless believes these circumstances are rare.

g. Violates the Administrative Procedure Act

#### Comments Received

Numerous commenters objected to the NPRM on grounds that it is nothing more than a politically motivated rulemaking, demonstrated by ATF’s use of a politicized nomenclature (*i.e.*, “ghost guns”) and reports that rulemaking was directed by certain lobbying groups. They further argued that the entire rule is arbitrary and capricious under 5 U.S.C. 706(2)(A) of the Administrative Procedure Act (“APA”) because the agency relied on factors that Congress did not intend for it to consider. As an example, commenters stated that the definitions of “partially complete” and “split or modular frame or receiver” rely on balancing tests that have no weighted or comprehensible standard and can create unfair surprise.

921(a)(10), (a)(21)(A), 923(a). To address concerns and reduce the burden on licensed gunsmiths required to be re-licensed as manufacturers, this final rule expressly authorizes licensed manufacturers to adopt the existing markings on firearms unless they have been sold or distributed to a person other than a licensee. Additionally, the final rule clarifies that licensed manufacturers and importers, who are permitted to act as licensed dealers without obtaining a separate dealer’s license, can conduct same-day adjustments or repairs on firearms without recording an acquisition provided the firearm is returned to the person from whom it was received. Further, this rule allows licensees who do not have engraving equipment to take a PMF to and directly supervise on-the-spot engraving of a serial number on the firearm by another licensee or even an unlicensed engraver so long as the dealer does not relinquish supervisory control over the firearm.

Moreover, commenters argued the rule violates the APA because the proposed definitions are arbitrary and capricious and because they fail to account for the reliance interests of those affected by the action and fail to explain the agency’s departure from prior policy. For example, commenters said that ATF’s proposal to change serial marking requirements and the definition of “gunsmith” fails to provide any data or explanation as to how traces are failing under the current system due to existing marking requirements or why the definition for “gunsmith” is suddenly changing after many years.

Numerous commenters further argued that the rule, especially with respect to the proposed definition of “frame or receiver” to include partially completed frames or receivers, is arbitrary because the agency failed to address why it is deviating from its legal reasoning that it had made in recent past cases before Federal courts and on which the public relied. For example, commenters highlighted ATF’s arguments presented in *City of Syracuse v. ATF*, 1:20-cv-06885, 2021 WL 23326 (S.D.N.Y. Jan. 2, 2021), and *California v. ATF*, 3:20-cv-06761 (N.D. Cal.). In ATF’s Motion to Dismiss in *California*, the agency wrote: “The longstanding position of ATF is that, where a block of metal (or other material) that may someday be manufactured into a receiver bears no markings that delineate where the fire-control cavity is to be formed and has not yet been even partially formed, that item is not yet a receiver and may not ‘readily be converted to expel a projectile.’” Fed. Defs.’ Mot. Dismiss, at 2, ECF No. 29 (Nov. 30, 2020). One commenter pointed out that, in that same Motion to Dismiss, ATF stated that its refusal to classify unfinished lower receivers as firearms is based on concurring expertise from DOJ. *Id.* at 18–19 (citing Shawn J. Nelson, *Unfinished Lower Receivers*, 63 U.S. Attorney’s Bulletin No. 6 at 44–49 (Nov. 2015)). Similarly, commenters stated that ATF was clear in *City of Syracuse* that “an unmachined frame or receiver is not ‘designed to’ expel a projectile because its purpose is not to expel a projectile. Rather its purpose is to be incorporated into something else that is designed to expel a projectile.” Mem. Supp. Fed. Defs.’ Mot. Summ. J., at 21, ECF No. 98 (Jan. 29, 2021). Another commenter cited *Police Automatic Weapons Services, Inc. v. Benson*, 837 F. Supp. 1070 (D. Or. 1993), in which, before Congress ended the manufacture of machineguns for sale to ordinary persons, ATF had apparently refused to register incomplete machinegun

receivers because they were not complete enough to be considered a receiver. Similarly, one manufacturer stated that the rule's more expansive regulation governing frames or receivers would run counter to the legal reasoning ATF relied on in three prior classifications to the company dated February 2015, November 2015, and January 2017 regarding certain types of receiver blanks.

#### Department Response

The Department disagrees that this rulemaking violates the APA or is an arbitrary or capricious reaction to the proliferation of "ghost guns." This rule cites ATF statistics and media reports demonstrating the steady increase in the number of PMFs recovered from crime scenes (including homicides) throughout the country, and the small number of crime gun traces to an individual purchaser that were successful in relation to numerous attempted traces of PMFs (generally by tracing a serial number engraved on a handgun slide, barrel, or other firearm part not currently defined as a frame or receiver, but recorded by licensees in the absence of other markings). The NPRM and this rule cite numerous criminal cases brought by the Department against unlicensed persons who were engaged in the business of manufacturing and selling PMFs without a license, and prohibited persons found in possession of such weapons. This rule cites reports and studies showing that the problem of untraceable firearms being acquired and used by violent criminals and terrorists is international in scope. This rule details how unmarked firearms undermine the GCA's comprehensive regulatory scheme that requires licensing, marking, recordkeeping, and background checks for all firearms acquired and transferred by or through firearms licensees. This rule further explains how allowing persons to be licensed as dealer-gunsmiths will make professional marking services more available to unlicensed individuals, and make it possible for other licensees to receive and transfer PMFs should they choose to accept them into inventory in the course of their licensed activities. The Department carefully considered all commenters' concerns in finalizing this rule in accordance with the APA.

The Department does not agree with commenters who said that the number of PMFs involved in crime should be compared with the number of all firearms involved in crime. At the outset, there is no threshold for establishing when law enforcement agencies may take steps to reduce

violent crime. The subset of traces for PMFs is obviously fewer than those of commercially manufactured crime guns, which bear serial numbers and other identifying markings and make up a much greater volume of marked weapons in circulation, and firearms with serial numbers are much more likely to be traced successfully by law enforcement than PMFs without serial numbers. Regardless, with better and cheaper technologies, unmarked firearms are becoming more easily and repeatedly made by individuals using personally owned or leased equipment, including 3D printers. It is clear from this data that PMFs are increasingly being used in crime throughout the United States and internationally with no reason to believe the trend will not continue. Statistics concerning crime gun tracing of commercially manufactured firearms do not lessen the necessity of this rule to improve public safety in the context of unmarked PMFs.

The Department disagrees with commenters who said that ATF is changing its position that a solid block of metal (or other material) that may someday be manufactured into a receiver that bears no markings that delineate where the fire-control cavity is to be formed, and has not yet been even partially formed, is not a "receiver." Machining, indexing, or lack thereof, to the fire-control cavity remain an important factor in the readily completed, assembled, restored or otherwise converted analysis. To buttress this point, the final rule expressly excludes from the definitions of "frame" and "receiver," "a forging, casting, printing, extrusion, unmachined body, or similar article that has not yet reached a stage of manufacture where it is clearly identifiable as an unfinished component part of a weapon (e.g., unformed block of metal, liquid polymer, or other raw material)." In other words, an item in a primordial state, such as a solid block of metal, liquid polymer, raw material, or other item that is not clearly identifiable as a component part of a weapon, is not a "frame" or "receiver" under this rule. This rule as proposed and finalized clarifies the distinction between a primordial object and a partially complete frame or receiver billet or blank that may be considered a "frame" or "receiver" under certain circumstances.

However, prior to this rule, ATF did not examine templates, jigs, molds, instructions, equipment, or marketing materials in determining whether partially complete frames or receivers were "firearms" under the GCA. For this reason, ATF issued some classifications

concluding that certain partially complete frames or receivers were not "frames or receivers" as now defined in this rule. This change to allow consideration of templates, jigs, instructions, *etc.* in classification determinations does not run afoul of the APA. *See F.C.C. v. Fox*, 556 U.S. 502, 517 (2009) (Federal Communications Commission did not act arbitrarily when it changed its policy regarding fleeting expletives). The Supreme Court "fully recognize[s] that regulatory agencies do not establish rules of conduct to last forever and that an agency must be given ample latitude to adapt [its] rules and policies to the demands of changing circumstances." *Motor Vehicle Manufacturer's Ass'n v. State Farm Mut. Auto. Ins. Co.*, 463 U.S. 29, 41 (1983) (citation and internal quotation marks omitted). The aggregation of a template or jig with a partially complete frame or receiver, such as those included in firearm parts kits, can serve the same purpose as indexing, making an item that is clearly identifiable as a partially complete frame or receiver into a functional one efficiently, quickly, and easily (*i.e.*, "readily"). Because indexing allows partially complete frames or receivers to be completed efficiently, quickly, and easily, such articles will now be considered frames or receivers under this rule. As stated in the NPRM and this final rule, changing circumstances—*i.e.*, more advanced and accessible technology, the subsequent proliferation of "80% receivers," and the resulting threat to public safety from unserialized firearms—necessitate this change.

With regard to the comment on gunsmiths, the rule is necessary to explain who is required to be licensed as a gunsmith, as distinguished from a manufacturer. In addition to comments concerned with the application of the proposed definition, ATF has received numerous inquiries over the years asking whether persons are required to be licensed as dealer-gunsmiths (Type 01) or manufacturers (Type 07). *See, e.g.*, ATF Ruls. 2009–1, 2009–2, 2010–10, and 2015–1. The current definition of "engaged in the business" in 18 U.S.C. 921(a)(21)(D) and "gunsmith" in 27 CFR 478.11 describe a gunsmith as a "person who devotes time, attention, and labor to engaging in such activity as a regular course of trade or business with the principal objective of livelihood and profit" without explaining the range of commercial activities gunsmiths perform, or when those activities can be performed on firearms for sale or distribution without a manufacturer's license. This rule,

therefore, necessarily clarifies the meaning of that term.

#### h. Violates the Prohibitions Against Creation of a Gun Registry

##### Comments Received

Numerous commenters objected to the proposed serial marking requirements, claiming it is a ploy by the Government to subject law-abiding gun owners who enjoy and have the right to build their own firearms to a rigorous registration requirement. They claimed that the requirement that PMFs be serialized only leads to an illegal gun registry, which ATF is forbidden from creating under Federal law. Commenters similarly opined that the extended recordkeeping requirement is a clear sign that ATF intends to have a registry of all firearms owners going far beyond those who are legally required to register firearms under the NFA.

##### Department Response

The Department disagrees that this rule creates a registry of PMFs, for several reasons. First, neither the GCA nor this implementing rule requires unlicensed individuals to mark (non-NFA) firearms they make for their personal use, or when they occasionally acquire them for, or sell or transfer them from, a personal collection to unlicensed in-State residents consistent with Federal, State, and local law. There are also no recordkeeping requirements imposed by the GCA or this rule upon unlicensed persons who make their own firearms, but only upon licensees who choose to take PMFs into inventory. And, under this final rule, when FFLs do choose to accept PMFs into inventory, and no manufacturer name has been identified on a PMF (if privately made in the United States), the words “privately made firearm” (or the abbreviation “PMF”) are required to be recorded as the name of the manufacturer, not the name of the actual private maker.

Second, records of production, acquisition, and disposition of all firearms are required by the GCA, 18 U.S.C. 923(g)(1)(A) and (g)(2), to be completed and maintained by FFLs at their licensed business premises for such period, and in such form, as the Attorney General may prescribe by regulations. In this rule, ATF is exercising that authority to change the manner and duration in which those records are maintained. At present, licensees are required to maintain their acquisition and disposition records for at least 20 years. This rule merely extends the 20-year retention period so

that those records are not destroyed, and thus can be used for tracing purposes.

Although ATF has the authority to inspect an FFL’s records under certain conditions, *see* 18 U.S.C. 923(g)(1)(B)–(C), the records belong to and are maintained by the FFLs, not the government. Only after an FFL discontinues business does the GCA, 18 U.S.C. 923(g)(4), require FFLs to provide their records to ATF so that tracing of crime guns can continue.<sup>113</sup> In fact, the provision cited by some commenters, 18 U.S.C. 926(a), expressly provides that “[n]othing in this section expands or restricts the Secretary’s authority to inquire into the disposition of any firearm in the course of a criminal investigation.” Moreover, Federal law has long prohibited ATF from consolidating or centralizing licensee records. Since 1979, congressional appropriations have prohibited ATF from using any funds or salaries for the consolidation or centralization of records of acquisition and disposition of firearms maintained by FFLs. *See* Treasury, Postal Service, and General Government Appropriations Act, 1980, Public Law 96–74, 93 Stat. 559, 560 (1979). This annual restriction became permanent in 2011. *See* Public Law 112–55, 125 Stat. 632 (2011). Thus, ATF is already restricted by law from creating any such registry, and this rule does not create one.<sup>114</sup>

<sup>113</sup>The out-of-business firearms transaction records are indexed by abbreviated FFL number so that they may be accessed when needed to complete a firearm trace request involving a licensee that is no longer in business. Out-of-business firearms transaction records are not searchable by an individual’s name or other personal identifiers. In 2006, ATF transitioned from using microfilm images of records to scanning records into a digital storage system with images that are not searchable through character recognition, consistent with ATF’s design and use of its prior Microfilm Retrieval System. A 2016 GAO Audit (GAO–16–552) concluded that ATF’s digital system complies with the restrictions prohibiting consolidation or centralization of FFL records. *See also Statutory Federal Gun Registry Prohibitions and ATF Record Retention Requirements*, Congressional Research Service (March 4, 2022), <https://crsreports.congress.gov/product/pdf/IF/IF12057> (last visited Apr. 3, 2022).

<sup>114</sup>*See* 124 Cong. Rec. 16637 (June 7, 1978) (statement of Rep. Drinan) (“The most frequent criticism of the March 21 regulations is their alleged establishment of a ‘national gun registration’ system. Is it possible to establish such a system under a set of regulations which prohibit the submission, collection, or maintenance on file of the identities of owners and purchasers of firearms? Clearly, the answer is no. These regulations are not directed at gun purchasers; they are designed instead to aid law enforcement officers by requiring that firearms manufacturers and dealers keep track of firearms transactions. Put more simply, the regulations will trace guns, not gun owners. Individual purchasers of firearms will not have to register their weapons, and the Bureau will not establish a centralized registry of firearms owners.”).

i. Violates 18 U.S.C. 242 and 1918

##### Comments Received

Out of concern regarding their rights under the Second Amendment to the U.S. Constitution, several commenters claimed that by working on this rule, ATF officials are violating 18 U.S.C. 242, which makes it a crime for a person acting under color of any law to willfully deprive a person of a right or privilege protected by the Constitution or laws of the United States. Commenters also claim that ATF officials and employees are likewise violating their oath of office to support and defend the U.S. Constitution (particularly the Second Amendment), which the commenters state is punishable under 18 U.S.C. 1918.

##### Department Response

The Department disagrees that any official involved in promulgating or implementing this rule violates 18 U.S.C. 242 or 1918, or any other Federal law. As stated previously, this rule does not impact the Second Amendment rights of law-abiding citizens to keep and bear firearms for lawful personal use. The regulations proposed and finalized herein do not raise Second Amendment concerns because they are “presumptively lawful regulatory measures” that “impos[e] conditions and qualifications on the commercial sale of arms.” *Heller*, 554 U.S. at 626–27 & n.26.

### 3. Concerns With Proposed Definitions

#### a. General Concerns With Proposed Definitions

##### Comments Received

Numerous commenters stated that no changes to the regulations are needed because the current definitions are adequate. They also believe that ATF’s private letter rulings are adequate communications to provide information to the industry and firearms owners. Commenters opposed to the proposed definitions and new terms in the NPRM stated that the new definitions, which they assert are vague, use terms and phrases that are even more unclear. For instance, commenters argued that although “partially complete receiver” is defined, the definition has even more vague, problematic terms such as “clearly identifiable,” “unfinished component part of a weapon,” “critical stage of manufacture,” “sufficiently complete to function,” and “primordial state.” Similar to the due process and APA concerns discussed earlier, one major objection of commenters to the proposed definitions was that the definitions are too broad to be workable.



A majority of these comments focused on the supplemental definitions of “split or modular frame or receiver” and “partially complete, disassembled, or inoperable frame or receiver.”

Several commenters stated that the very problem ATF is trying to solve is made worse by the proposed regulations, as no reasonable person would be able to determine which component or components of a given firearm constitute a frame or receiver. As summed up by some commenters: “The proposed definition creates a reality where a reasonable person would be forced to assume that every component of the firearm which meets the proposed definition of firearm frame or receiver is such, *unless* they are aware of a determination to the contrary by ATF. Therefore, consumers must constantly be in doubt as to whether a firearm in their possession has been properly marked in accordance with the law, or if they are in possession of an illegal item.” Moreover, as discussed in Section IV.B.13.b of this preamble, numerous commenters opined that the proposed definition of “frame or receiver” and its supplemental definitions, which would trigger new marking or recordkeeping requirements, would be cost prohibitive to the industry and to firearms owners.

#### Department Response

The Department disagrees with commenters who stated that the current definitions are adequate. The NPRM and this final rule explain in detail how the current definitions of “firearm frame or receiver” and “frame or receiver” in 27 CFR 478.11 and 479.11 do not adequately describe the major component of split or modular weapons or muffler or silencer devices required to be identified and recorded by licensees as a “firearm.” The current definition describes a housing for three fire control components: Hammer, bolt or breechblock, and firing mechanism. But the vast majority of firearms in common use today do not have a single housing for all of those components, and numerous firearms today are not hammer-fired. They often have split frame or receiver designs, and many are striker-fired. As stated previously, three courts have already applied ATF’s definition of “frame or receiver” in a way that would leave most firearms currently in circulation in the United States without an identifiable frame or receiver. See *United States v. Rowold*, 429 F. Supp. 3d 469, 475–76 (N.D. Ohio 2019) (“The language of the regulatory definition in § 478.11 lends itself to only one interpretation: Namely, that under the GCA, the receiver of a firearm must

be a single unit that holds three, not two components: (1) The hammer, (2) the bolt or breechblock, and (3) the firing mechanism.”); *United States v. Roh*, SACR 14–167–JVS, Minute Order p. 6 (C.D. Cal. July 27, 2020); *United States v. Jimenez*, 191 F. Supp. 3d 1038, 1041 (N.D. Cal. 2016).

The proposed new terms and definitions are also needed to explain when weapon parts kits, frame or receiver parts kits, and multi-piece frames or receivers are “firearms” and thus subject to regulation, and how licensees can accept unmarked PMFs into their inventories. The rule points out that silencer manufacturers are currently uncertain when and how each small silencer part must be marked given that each part is defined as a “silencer” under the law. Clarifying these issues in individual private letter rulings is not adequate to provide sufficient notice and guidance to the licensed community and public at large as to how firearms are defined and regulated. In addition, letter rulings are only applicable for the precise sample submitted to ATF, and those classifications may then be misapplied (as some have done) to other items that may appear similar, but have legally important differences. For these reasons, the Department has addressed these issues through this rulemaking to promulgate new definitions that apply to all existing firearm designs as well as to accommodate future changes in firearms technology and terminology.

Nonetheless, the Department agrees with commenters that the supplement to the proposed definition of “frame or receiver” entitled “split or modular frame or receiver” could have been costly to licensees to implement, and that the supplement “partially complete, disassembled, or inoperable frame or receiver” should be revised to provide more clarity on how it applies to the definition of “frame or receiver.” In response to comments, in the final rule the Department has removed the supplement entitled “split or modular frame or receiver,” made additions to explain how multi-piece frames or receivers must be identified, and made clarifying changes to the supplement entitled “partially complete, disassembled, or inoperable frame or receiver.”

Finally, although the Department disagrees that certain terms in this rule were vague, additional clarity has been provided to explain the meaning of those terms. Examples of articles that are “clearly identifiable as an unfinished component part of a weapon” are unformed blocks of metal, liquid polymers, and other raw

materials. The dictionary definition of the term “primordial” was adopted and explained in footnote 49 of this preamble. The term “sufficiently complete to function as a frame or receiver” is no longer used in the regulatory text. That term was replaced with “to function as a frame or receiver,” which is described as “to house or provide a structure for the primary energized component of a handgun, breech blocking or sealing component of a projectile weapon other than a handgun, or internal sound reduction component of a firearm muffler or firearm silencer, as the case may be.”

#### b. Definition of “Firearm” and Weapon Parts Kits

##### Comments Received

In addition to stating that ATF does not have authority to include weapon parts kits in the definition of “firearm,” several commenters also stated the definition was flawed and would serve no purpose. For instance, commenters said it is futile to regulate a weapon parts kit because a kit could be sold without a firing pin and thus would not be in a state where it is readily completable, enabling kit manufacturers to circumvent the definition by selling the kit separately from a cheap and readily available pin. Other commenters stated that if ATF’s definitions mean that a “weapon parts kit” containing all unregulated parts, including a so-called “80% receiver,” is a “firearm,” this would raise the question of whether a kit with a forging in a primordial state is still a firearm because the pieces taken together could expel a projectile by an action of an explosive even if it is not readily convertible for that purpose. They stated that under ATF’s interpretation it appears to be irrelevant whether the part that could become the frame or receiver “may readily be converted” as long as it is “designed to expel a projectile by action of an explosive.” Separately, since the preamble described “weapons parts kits” as having “most or all of the components,” commenters questioned whether a kit that does not contain all of the necessary components to expel a projectile by the action of an explosive is still “designed” or “readily convertible” to do so. Commenters thus sought more clarity on what components must be present in a kit to constitute a firearm.

#### Department Response

The Department disagrees with commenters that including weapon parts kits in the definition of “firearm”

serves no purpose. The GCA is clear that when a weapon will, is designed to, or may readily be converted to expel a projectile by the action of an explosive, the weapon is a “firearm” under 18 U.S.C. 921(a)(3)(A). As explained above and in the NPRM, relevant case law makes clear that weapon parts kits that are designed to or may readily be assembled, completed, converted, or restored to expel a projectile by the action of an explosive qualify as a “firearm” under 18 U.S.C. 921(a)(3)(A). See Section III.A, *supra*; 86 FR 27726 & nn.39–40. The rule thus amends the existing definition to explicitly note this application of the term “firearm” to include such weapon parts kits. The rule also relies on existing case law to provide a definition of the term “readily” and to detail the factors relevant to making that determination when classifying firearms. See Section III.C, *supra*; Section IV.B.3.j, *infra*. As earlier explained, in recent years, manufacturers and retailers have been selling to individuals weapon parts kits with incomplete frames or receivers, commonly called “80% receivers,” without conducting background checks or maintaining records. Some of these parts kits contain all of the necessary components (finished or unfinished), along with jigs, templates, or other tools that allow an individual to complete a functional weapon with minimal effort, expertise, or equipment within a short period of time.

The Department disagrees with commenters who said that regulating weapon parts kits that were missing certain parts, such as a firing pin, would be futile. A weapon missing a firing pin is still a “firearm” under section 921(a)(3)(A) because it is designed to expel a projectile.<sup>115</sup> The fact that the same exact pistol without a firing pin has been disassembled into a parts kit does not alter the weapon’s design. Moreover, one of the considerations in determining whether a weapon, including a weapon parts kit, may “readily” be converted to expel a projectile is whether additional parts are required, and how efficiently, quickly,

and easily they can be obtained and assembled.

The Department agrees that certain essential parts could be removed from the kit, potentially making it difficult to determine whether such a kit or aggregation of parts may readily be converted to fire. However, it would be impossible for the Department to set forth in the regulations a precise minimum percentage of completion, maximum time period, maximum level of expertise, or type or number of parts necessary to convert each and every make, model, and configuration of weapon parts kits now in existence, or that may be produced in the future. The Department believes that it is constitutionally, legally, and practically sufficient, and consistent with relevant case law, to explain in this rule that the conversion must be fairly or reasonably efficient, quick, and easy (though not necessarily the most efficient, speediest, or easiest process) after examining the enumerated factors. Additionally, if persons remain uncertain as to whether a particular weapon parts kit is a “firearm,” they may submit a voluntary request to ATF for a classification in accordance with this rule.

While these determinations must necessarily be made on a case-by-case basis, the Department believes that the term “readily” and the factors in this rule provide sufficient notice that certain weapon and frame or receiver parts kits are regulated under the GCA. It is not the purpose of the rule to provide guidance so that persons may structure transactions to avoid the requirements of the law. Persons who engage in the business of importing, manufacturing, or dealing in weapon and frame or receiver parts kits must be licensed, mark the frames or receivers within such kits with serial numbers and other marks of identification, conduct background checks, and maintain transaction records for them so that they can be traced by law enforcement if involved in crime.

#### c. Definition of “Frame or Receiver” Comments Received

Despite the grandfather provision ATF provided in the NPRM for existing frames or receivers, commenters said there is still confusion because one cannot examine the definition of “frame or receiver” to determine with any certainty whether a specific part of a firearm that was previously classified as a single frame or receiver is redefined as a split or modular frame or receiver and whether the entire scope of the definition is dependent upon the Director. Other commenters asserted

that the definition of “frame or receiver” is vague because “almost any housing or structure that is at all visible from the exterior [is] susceptible to a classification as a frame or receiver” or would make “every single part of a firearm a ‘fire control component’” such that firearms like the AR–15 may now include as many as ten frames or receivers.

Another commenter stated that the open-ended nature of fire control components makes it difficult, if not impossible, to determine what constitutes the frame or receiver. The commenter explained that some magazine catches could be a frame or receiver because those components are visible from the exterior of a completed firearm and provide a structure to hold or integrate a component necessary for the firearm to initiate or continue the firing sequence (*e.g.*, a magazine for use in a semiautomatic pistol equipped with a magazine disconnect). The commenters stated that ATF’s illustrations purport to indicate that only one part is the frame or receiver when in fact the depictions show firearms with more than one component that meet the definition using only the listed fire control components. For example, the commenters stated: “The hinged revolver example indicates that the ‘frame’ is the rear half of the firearm, even though the front half of the firearm obviously provides a ‘housing or structure’ to ‘hold or integrate’ the cylinder when the firearm is assembled.” Commenters also pointed out that ATF did not explain what it means by “other reliable evidence” where it stated that: “Any such part identified with a serial number shall be presumed, absent an official determination by the Director or other reliable evidence to the contrary, to be a frame or receiver.” Given that firearms classifications are not released to the public, the commenters questioned how anyone is to know whether a given firearm has or has not received an official determination.

#### Department Response

The Department believes that the grandfather provision in the proposed rule would have eliminated most of the concerns raised by commenters concerning the proposed definition of “frame or receiver” and agrees that it relied heavily on ATF classifications of specific components as a “frame or receiver.” Nonetheless, as stated previously, the Department agrees with commenters that the definition of “firearm” in 18 U.S.C. 921(a)(3)(B) is best read to mean a single part of a weapon or device as being “the” frame

<sup>115</sup> See, *e.g.*, *United States v. Rivera*, 415 F.3d 284, 285–87 (2d Cir. 2005) (pistol with a broken firing pin and flattened firing-pin channel); *United States v. Brown*, 117 F.3d 353, 356 (7th Cir. 1997) (gun with no firing pin); *United States v. Hunter*, 101 F.3d 82, 85 (9th Cir. 1996) (pistol with broken firing pin); *United States v. Yannott*, 42 F.3d 999, 1005 (6th Cir. 1994) (shotgun with broken firing pin); *United States v. York*, 830 F.2d 885, 891 (8th Cir. 1987) (revolver with no firing pin and cylinder did not line up with barrel); *United States v. Randolph*, No. 02 CR. 850–01 (RWS), 2003 WL 1461610, at \*2 (S.D.N.Y. Mar. 20, 2003) (gun consisting of “disassembled parts with no ammunition, no magazine, and a broken firing pin”).

or receiver. Accordingly, the final rule adopts certain subsets of the proposed definition firearm “frame or receiver” while providing new distinct definitions for “frame” and “receiver.” Whereas the proposed rule would have considered any housing or structure for any fire control component a frame or receiver, the final rule focuses these definitions by describing a specific housing or structure for one specific type of fire control component. This will help licensees and the public determine on their own which portion of a firearm is the “frame or receiver” without an ATF classification.

In the final rule, the Department has established new definitions for the term “frame” to apply to handguns; “receiver” to apply to rifles, shotguns, and projectile weapons other than handguns; and “frame” or “receiver” to apply to firearm mufflers and silencers. More specifically, with respect to handguns, the Department is adopting in this final rule a definition of “frame” that incorporates language similar to that proposed by commenter Sig Sauer, Inc., described below. The term “frame” will be defined as: “the part of a handgun, or variants thereof, that provides housing or a structure for the primary energized component designed to hold back the hammer, striker, bolt, or similar component prior to initiation of the firing sequence (*i.e.*, sear or equivalent), even if pins or other attachments are required to connect such component to the housing or structure.” This definition is consistent with the common understanding of the term “frame” as the “basic unit of a handgun” that holds the “operating parts” of the weapon.<sup>116</sup> These operating parts necessarily include the sear or equivalent component that is energized prior to initiation of the firing sequence.

However, the Department does not adopt the same definition with respect to rifles, shotguns, and projectile weapons other than handguns which are commonly understood to incorporate a “receiver.” This term is generally understood to be the part “in which the action of a firearm is fitted and to which the breech end of the barrel is attached.”<sup>117</sup> Because the “action” of a firearm is commonly understood to mean “the physical mechanism that manipulates cartridges and/or seals the breech,”<sup>118</sup> the term “receiver” is defined in the final rule as: “the part of

a rifle, shotgun, or projectile weapon other than a handgun, or variants thereof, that provides housing or a structure for the primary component designed to block or seal the breech prior to initiation of the firing sequence (*i.e.*, bolt, breechblock, or equivalent), even if pins or other attachments are required to connect such component to the housing or structure.”

For purposes of these definitions, the terms “variant” and “variants thereof” are defined as: “a weapon utilizing a similar frame or receiver design irrespective of new or different model designations or configurations, characteristics, features, components, accessories, or attachments. For example, an AK-type firearm with a short stock and a pistol grip is a pistol variant of an AK-type rifle, an AR-type firearm with a short stock and a pistol grip is a pistol variant of an AR-type rifle, and a revolving cylinder shotgun is a shotgun variant of a revolver.” The definition of frame or receiver with respect to a firearm muffler or silencer is described in Section IV.B.3.e of this preamble. The final rule does not adopt the proposed supplement entitled “Split or Modular Frame or Receiver.”

Additionally, in response to comments, the Department has added a new “grandfather” supplement expressly defining the term “frame or receiver” to include prior ATF classifications of a specific component as the frame or receiver, and clarified how multi-piece frames or receivers with modular subparts are defined and must be marked. These amendments should greatly diminish commenters’ concerns regarding any lack of specificity or confusion regarding the particular models listed in the proposed definitions. The final rule includes a wide variety of examples and pictures to illustrate the frame or receiver of popular models and variants thereof, as well as examples of particular models previously classified by ATF that are grandfathered, such as the lower receiver of AR-15 variant firearms which houses the trigger mechanism and hammer, rather than the breech blocking or sealing component (*i.e.*, the bolt).

#### d. Alternative Definitions of “Frame or Receiver”

##### Comments Received

Commenters opposed to the proposed rule have either urged ATF to withdraw the rulemaking or come up with a more concise, less complex definition. While some commenters agreed that ATF’s current definition of “frame or receiver” is outdated, “antiquated,” or

“confusing,” several commenters from the industry said a new definition should be tailored to focus on new designs and should be done with meaningful input from stakeholders.

A few commenters stated that there were numerous other ways for ATF to amend its definition to adapt to technological advances while also being consistent with the wider public’s longstanding interpretation of the term to mean a single component of a given firearm. Commenter Sig Sauer, Inc., for example, suggested the following possible alternative definitions: (1) “Firearm frame or receiver” means “the component of the firearm which provides a housing for the component responsible for constraining the energized component of the firearm (*i.e.*, the sear or equivalent thereof)”; (2) “Firearm frame or receiver” means “the component of the firearm which provides a housing for the component which the operator interacts with to initiate the firing sequence of the firearm (*i.e.*, the triggering mechanism, or the equivalent thereof)”; or (3) “Firearm frame or receiver” means “the component of the firearm which incorporates or provides a housing for the component which interacts with the barrel to form the chamber of the firearm.”

One commenter stated that ATF’s goal to update the definition of “frame or receiver” to accommodate split-framed firearms would be met simply by re-writing the existing definition to read: “the part of a firearm that provides housing for the hammer, bolt or breechblock, firing mechanism, or at its forward portion receives the barrel.” Another commenter similarly suggested that ATF use “or” rather than “and” as the conjoiner in the current definition of “firearm frame or receiver,” such that the list of the components housed by the frame or receiver would read “the hammer, bolt or breechblock, or firing mechanism.” Another commenter suggested that ATF adopt the definition of “receiver” that is in the Sporting Arms and Ammunition Manufacturers’ Institute’s (“SAAMI’s”) Glossary of Industry Terms available on that organization’s website.<sup>119</sup> Another commenter suggested a point system that would assign points (*e.g.*, the “fire control group” would be three points, the hammer would be one point, and

<sup>119</sup> SAAMI defines the term “receiver” as “[t]he basic unit of a firearm which houses the firing and breech mechanism and to which the barrel and stock are assembled. In revolvers, pistols, and break-open guns, it is called the Frame.” See SAAMI, *Glossary of Industry Terms*, available at <https://saami.org/saami-glossary/?letter=R> (last visited Mar. 25, 2022).

<sup>116</sup> See footnote 7, *supra*.

<sup>117</sup> *Id.*

<sup>118</sup> Prasanta Kumar Das, Lalit Pratim Das, & Dev Pratim Das, *Science and Engineering of Small Arms*, Ch. 5.4 (2022).

the striker would be one point). Under this suggestion, the external part that has the most points would be the frame or receiver.

While some commenters suggested ATF should just accept the manufacturer-designated component identified as “firearm” for each model, another commenter, SAAMI, suggested that, with respect to the AR–15 Colt Sporter, ATF could simply amend the existing regulation to specify that the lower receiver is the “frame or receiver” of that firearm. Another commenter suggested that frame or receiver should be defined as: “that portion of the weapon, that holds the fire control group, consisting of any of the following, trigger, sear, safety and hammer if the weapon is hammer fired.” According to the commenter, this would consistently mean the lower receiver and encompass all weapons, *i.e.*, the lower on an AR–15, the lower on a Glock, the lower on a break open shotgun (not including barrel), the lower on a revolver, and the lower on a semiautomatic pistol would be the “firearm” regardless of the striker fire or hammer fire (because it holds the trigger or sear). This, according to the commenter, would also encompass the side plate on certain machineguns.

To address the cases in which ATF has not prevailed in litigation, one commenter suggested a more specific fix that would define frame or receiver as the “mounting point, housing structure, or the significant part thereof for a firearm’s barrel, barrels or barrel assembly since all guns have at least one barrel.” Or, to address that striker-fired mechanisms are not fully captured under the current law, commenters said the definition could be easily amended to “that part of a firearm which provides housing for the hammer *or* striker, bolt or breechblock, and firing mechanism, and which is usually threaded at its forward portion to receive the barrel.”

#### Department Response

The Department agrees with commenters who stated that ATF’s current definition of “frame or receiver” is outdated and confusing, and that the proposed definition should be simplified. For this reason, ATF is providing a new regulatory definition of “frame or receiver” to encompass existing and new firearm designs. The GCA and NFA do not define the term “frame or receiver,” so only the regulatory definitions of that term in 27 CFR parts 478 and 479 are being redefined. For the reasons previously discussed, the Department agrees that a more concise, less complex definition that focuses on a single part of each

weapon is preferable, and will adopt a definition of “frame” with respect to handguns and “receiver” with respect to rifles, shotguns, and projectiles weapons other than handguns.

The Department disagrees with commenters who suggested amending the current definitions of “frame or receiver” by replacing “and” with “or” as the conjoiner with respect to the listed components of the current definition. Under this alternative, any part of a firearm that houses either the hammer, or a bolt or breechblock, or a firing mechanism, or that receives the barrels would be considered frames or receivers. Thus, under this alternative, there could exist even more firearm parts that would constitute a “frame or receiver” than identified by the proposed rule. This alternative also does not identify a single “receiver” in numerous split receiver firearms. In an AR–15-type rifle, for example, the hammer, firing mechanism, and forward portion that receives the barrel are all in the lower receiver, but the bolt or breechblock is in the upper receiver. The same problem exists when applying SAAMI’s definition from its Glossary of Industry Terms because the firing and breech mechanisms are not in the same “receiver.” While the lower receiver houses the firing mechanism and is attached to the stock, the upper receiver houses the breechblock and is attached to the barrel. Therefore, under SAAMI’s published definition, in an AR–15-type firearm, for example, there would still be more than one part that would be defined as a “frame or receiver” on this weapon as well as on numerous split or modular models of firearms in common use today. This alternative definition also does not explain how it would apply to firearms that do not have a hammer, but are fired using a striker, which may be located in different housings depending on the type of firearm.

The Department also disagrees with the point system recommended by one commenter because it does not explain how the point values were reached, and why fire control components in other portions of the assembled weapon were not assigned any points. It would not address firearms that do not house all “fire control group” components within a single housing, or which have a remote trigger outside the weapon. In sum, this alternative would fall short of addressing all technologies or designs of firearms that are currently available, or may become available in the future. It also does not address potential changes in firearms terminology.

The Department agrees with SAAMI on expressing in the final rule that the

lower receiver of the AR–15 Colt Sporter (and variants thereof) is the “receiver” of that weapon. The final rule also includes a diagram of the AR–15 receiver. The Department will also grandfather all prior ATF classifications specifying which single component of a weapon is its frame or receiver. However, the Department will not grandfather ATF determinations that a partially complete, disassembled, or nonfunctional frame or receiver, including a parts kit, was not, or did not include, a firearm “frame or receiver” as defined prior to this rule, including those where ATF determined that the item or kit had not yet reached a stage of manufacture to be one. In any event, simply specifying that the lower receiver of the AR–15 Colt Sporter is a “receiver” does not solve the problem of defining the term “frame or receiver” with respect to all of the firearms with a split or multi-piece frame or receiver, or those that are striker fired. The problem remains that a court could decide that the current definition of “frame or receiver” does not apply to those firearms. Thus, the existing definition is not adequate with respect to the vast majority of firearms currently in the United States.

The Department declines to accept the proposed alternative definition saying that a “frame or receiver” is the portion of a weapon “that holds the fire control group, consisting of any of the following, trigger, sear, safety and hammer, if the weapon is hammer fired.” First, some firearms may be initiated manually by hand or “slam fired” without a part that actually holds a trigger, sear, safety, and hammer, and all complete, assembled weapons must have a frame or receiver. Second, not all of these fire control components may be in the same portion of the weapon, and some fire control groups, or portions thereof, may be found outside the frame or receiver, or triggered remotely. Nonetheless, the final rule accepts this alternative insofar as the “frame” of a handgun will be defined as the part that provides housing for the primary energized component designed to hold back the hammer or striker, which is generally the “sear.”

The Department also declines to accept the proposed alternative definition saying that the frame or receiver is the “mounting point, housing structure, or the significant part thereof for a firearm’s barrel, barrels or barrel assembly since all guns have at least one barrel.” This suggested definition would be inconsistent with what ATF and the firearms industry have understood to be the frame or receiver of numerous semiautomatic handguns, such as Glock

and Sig Sauer pistols and variants thereof, which is the lower portion of the weapon housing the sear, trigger mechanism, and other fire control parts. In such handguns, the barrel is housed in the upper slide. This suggested definition would, therefore, create confusion for many firearm manufacturers.

The new definitions in this rule are intended to describe the specific part of weapons that has traditionally been considered the frame or receiver for almost all firearms, but are general enough to accommodate future designs and changes in parts terminology. The few exceptions, such as the AR-15 rifle and Ruger Mark IV pistol, are grandfathered into the new definitions of those terms and may continue to be marked in the same manner as they have been prior to the effective date of this rule.

The Department acknowledges comments that stated that the current definition does not include a housing for “striker” fired weapons. The new definitions, which focus on the housing or structure for a single fire control component (*i.e.*, sear or equivalent for handguns, and bolt, breechblock, or equivalent for all other projectile weapons), are broad enough to cover both striker and hammer-fired weapons.

#### e. Definition of “Firearm Muffler or Silencer Frame or Receiver”

##### Comments Received

Some commenters opposed the proposed definition of “complete muffler or silencer device,” stating that the new definition would subject persons who possess a complete but disassembled silencer to the civil and criminal penalties associated with possession of a complete silencer. They also objected to frames or receivers of silencer devices, which may not be in an operational state, becoming subject to the new “readily” factors test used to establish the scope of weapon parts kits and firearm frame or receiver regulation. One manufacturer also pointed out that the definition of complete silencer device does not appear to include a silencer that uses a firearm-mounted flash-hider or other attachment devices for use if the mounting device is not included with or attached to the silencer.

Separately, while some commenters noted that the proposed definition of “firearm muffler or silencer frame or receiver” is an improvement on current law, there remains confusion regarding whether ATF intends for only a singular part to be the frame or receiver for firearm silencers. They stated that ATF

should clarify in the final rule that firearm silencers only need to be marked on a single piece that is the frame or receiver. Another manufacturer raised a similar concern that under the proposed definition, a non-welded suppressor’s end cap appears to be a frame or receiver requiring serialization. The manufacturer gave an example of Ruger Silent-SR and Silent SR ISB silencers that use a traditional baffle stack of non-welded individual baffles housed in a serialized tube. When installed, the end cap secures the baffles in place within the tube. The end cap, in this instance, seems to be a frame or receiver because it “provides housing or a structure . . . designed to hold or integrate one or more essential internal components of the device.” They stated that this conclusion, if accurate, would mean that a majority of suppressors utilizing a non-welded design have more than one frame or receiver, contrary to ATF’s position.

The same manufacturer also raised concerns about ATF’s attempt to memorialize the longstanding policy regarding silencer parts transferred between qualified individuals. The proposed rule allowed such transfers on the condition that “upon receipt, [the parts are] actively used to manufacture a complete muffler or silencer device.” The manufacturer argued that this section does not seem to allow a qualified manufacturer to send unmarked suppressor components to another qualified manufacturer for further manufacturing activities (*e.g.*, machining, coating, *etc.*) if the parts are not going to be assembled into a complete muffler or silencer device by the subcontractor manufacturer. Because “actively” is not defined, the commenting manufacturer stated it was unclear if it could transfer a large quantity of suppressor parts to a subcontractor to be consumed as needed by the manufacturer to make complete suppressors over an extended period.

##### Department Response

As stated previously, the Department agrees with commenters that the term “frame or receiver” is best read to mean a singular frame or receiver that must be identified with a single unique serial number. This would include the frame or receiver of a complete firearm muffler or silencer device. The Department also agrees with the comment that an end cap of an outer tube or modular piece could have been considered a structural component within the meaning of a frame or receiver as proposed. End caps are often damaged or destroyed upon expulsion of projectiles, leaving the muffler or silencer without any

traceable markings of identification. For this reason, the Department is amending the definition of those terms in the final rule as follows: “in the case of a firearm muffler or firearm silencer, the part of the firearm, such as an outer tube or modular piece, that provides housing or a structure for the primary internal component designed to reduce the sound of a projectile (*i.e.*, baffles, baffling material, expansion chamber, or equivalent). In the case of a modular firearm muffler or firearm silencer device with more than one such part, the terms shall mean the principal housing attached to the weapon that expels a projectile, even if an adapter or other attachments are required to connect the part to the weapon. The terms shall not include a removable end cap of an outer tube or modular piece.”

The Department also agrees with the commenter who stated that the proposed provision concerning transfers of firearm mufflers or silencers between qualified licensees could be read to exclude further manufacturing activities, such as further machining or applying protective coatings. For this reason, the Department has removed the term “actively,” and, instead, explained that mufflers or silencers must be marked by close of the next business day after the entire manufacturing process has been completed. The Department has also made minor amendments to the marking allowances to make clear that mufflers or silencers may be transferred between qualified manufacturers for further manufacture (*i.e.*, machining, coating, *etc.*) without immediately identifying and registering them. Once the new device with such part is completed, the manufacturer of the device must identify and register it in the manner and within the period specified in this part for a complete muffler or silencer device.

#### f. Definition of “Split or Modular Frame or Receiver”

##### Comments Received

With respect to ATF classifying the frame or receiver of a split or modular frame or receiver, numerous commenters objected to the definition not only on the grounds that it was too broad and confusing, but that to obtain certainty, it was largely dependent on ATF making classifications. They critiqued this process as lacking transparency, objectivity, and efficiency, as well as placing too much power in the hands of ATF. Numerous commenters said they introduce new models multiple times per year, and assuming a new determination is needed for each new model or

configuration, they have serious concerns that classification process would bury them in red tape. They stated the lead time, which is currently 6–12 months or more, would be much longer if hundreds of manufacturers were submitting to determine which component qualifies as the receiver, and this would be costly and disruptive to their companies. Due to the current delays in obtaining classifications, one commenter suggested the proposal could discourage classification requests rather than encourage them.

Several industry members stated that the firearm specific definitions under “split or modular frame or receiver” are confusing. It is not clear if the definitions apply only to firearms produced by those manufacturers listed or if it applies to all firearms that follow the same basic design. The confusion, they stated, is evident in the first of these definitions for “Colt 1911-type, Beretta/Browning/FN Herstal/Heckler & Koch/Ruger/Sig Sauer/Smith & Wesson/Taurus hammer fired semiautomatic pistols.” They questioned if the definition applies only to hammer-fired semiautomatic pistols manufactured by these discrete manufacturers or applies to all firearms that integrate an operating system that matches ATF’s provided definition for these firearms. Similarly, they stated ATF’s use of “-type” was unclear and asked, for instance, if “Sig Sauer P320-type semiautomatic pistols” is meant to include only P320s or exact replicas thereof, or if it is meant to convey a broader meaning of any firearm that has the same basic design, even if it uses different materials or has different gross dimensions (such as the Sig P365).

Additionally, commenters stated the nonexclusive lists used in definitions for frame or receiver indicated that there are other firearms designs and configurations not listed that fall into the category of “-type” but that are unknown to the public. Commenters also questioned what ATF meant by “comparable” when the NPRM explained that split or modular firearm designs that are not comparable to an existing classification would not be grandfathered in under the rule, thus making it possible that more than one part of the firearm would be the “frame or receiver” under the proposed definition.

Numerous commenters noted that several models of firearms were missing from the list of examples under the supplemental definition of frame or receiver entitled “split or modular frame or receiver” and that without clearer, more articulate lists, it appears that several models would be subject to more

marking requirements. One commenter, an FFL/SOT, expressed that the examples provided in the definitions do not include the most widespread and popular 22LR pistols such as the Ruger Mark I/II/III/IV, Browning Buckmark, S&W Model 41, and similar designs. They stated that millions of these have been sold over the past 70 years with the serialized firearm component varying between models from the assembly containing the barrel to the assembly containing the trigger mechanism. Without addressing these models, the comment said it is not clear where serialization should occur.

Similarly, another commenter provided examples of three models—the 512 Remington “Sportmaster” .22 rimfire bolt action tubular repeater, the 9422 Winchester .22 rimfire lever action repeater, and the 1911 and 1911A series Colt—and listed several parts of each firearm that the commenter believes would be subject to the marking requirements under the proposed definition. The FN PS90 firearm was another model raised as to which a commenter did not understand how the new definition would apply. The commenter stated that the upper of the FN PS90 is the serialized component and that the stock assembly (made entirely out of plastic) is a stock. Under the NPRM’s definition, the commenter stated that the stock would need to be serialized because it is made of two externally visible parts bolted together. Therefore, the commenter questioned whether each half of the stock would require its own serial number or if the parts would need to have injection molding done by a Type 07 licensee. Another commenter opined that the example for AK-type firearms is not consistent with many existing AK-type firearms already lawfully possessed. The commenter stated that while many of these firearms are marked on the identified “single receiver,” many of these types of firearms have been imported with the serial number only marked on the front trunnion. Thus, the commenter asked that this example be re-evaluated since it is unlikely ATF is intending to identify an unmarked part of thousands of firearms. Other commenters similarly said that ATF made an error when it listed the frame or receiver for a Beretta AR–70 type as the lower receiver because under existing precedent, the upper receiver of the AR–70 has been treated as the frame or receiver.

Finding the nonexclusive lists of frame or receiver examples to be inadequate and likely to lead to confusion or resulting in thousands of unnamed firearm types that will, by

default, have multiple frames or receivers, other commenters said ATF should make all known or existing classifications public or listed in the final rule. It is, they argued, the only way to ensure fairness.

#### Department Response

The Department agrees with numerous commenters that the supplement to the definition entitled “split or modular frame or receiver” would have been difficult for persons to apply under the proposed definition of “frame or receiver” that meant a housing for any fire control component. Additionally, the Department acknowledges commenters’ concerns that many models of firearms were not included, and that the proposed definition could lead persons to submit new classification requests rather than relying on the definition to identify the frame or receiver.

The Department, in response to these comments, is finalizing a definition of “frame or receiver” in a new § 478.12 that incorporates limited subsets of the proposed definition while providing distinct definitions for “frame” and “receiver.” The new definitions under “frame or receiver” focus on only one housing or structural component for a given type of weapon. Because the final rule focuses on a single component based on the recommendations of commenters, there is no longer a need for the supplement entitled “split or modular frame or receiver,” and it is not adopted in the final rule. The Department also acknowledges that the lower portion of the AR–70 was mistakenly identified as the receiver of that firearm in the NPRM. Under the final rule, the upper portion of the AR–70 remains the receiver of that firearm as described by the new definition of “receiver.”

Furthermore, to ensure that industry members and others can rely on ATF’s prior classifications, most prior ATF classifications, and variants thereof, have been grandfathered into the new definition of “frame or receiver” along with examples and diagrams of some of those weapons, such as the AR–15 rifle and Ruger Mark IV pistol. The only exceptions are classifications of partially complete, disassembled, or nonfunctional frames or receivers that ATF had determined did not fall within the definition of firearm “frame or receiver” prior to this rule. Any such classifications, including parts kits, would need to be resubmitted for evaluation. If persons remain unclear which specific portion of a weapon or device falls within the definitions of “frame” or “receiver,” then they may

voluntarily submit a request to ATF as provided in this rule.

g. Alternative for Defense Industry Under “Split or Modular Frame or Receiver”

Comments Received

Another commenter who represents members of the defense manufacturing industry suggested including as an example (“box-type”) of a split frame or receiver for which a single part had been previously classified by the Director “externally powered weapons.” The commenter explained as follows: Some externally powered designs include a part called the “front housing” that directly attaches to the existing frame or receiver and houses the breech. The front housing positions the breech to align with the bolt, which in turn, allows the bolt assembly to properly lock and drop the firing pin when the barrel is installed. Under the proposed definition, the commenter observed, it appears that this “front housing” could include this and other parts of the weapon not previously understood to be the frame or receiver, in addition to the existing “bathtub” or box-type receiver. As an alternative, the commenter suggested adding language that would exempt “externally powered weapons” that require “a separate electronic gun control unit to fire, and which [are] used solely in a government military platform, simulation, or training exercise, and where the weapon’s design does not have a civilian surrogate,” from either the definition of “partially complete” frames or receivers or “readily.”

As a completely different alternative, the same commenter requested that ATF include a simple annual notification procedure where qualified defense importer and manufacturer licensees could prove that they meet “opt out” requirements of the proposed rule and proceed with their processes under the existing regulatory requirements. The commenter suggested an “opt out” provision because the increased compliance obligations of the proposed rule would further complicate an already challenging workflow and impede contractual deadlines the commenter’s clients have with the U.S. Government.

Department Response

The Department declines to adopt the commenter’s suggestion to add ATF’s classification of “externally powered weapons.” As described above, the final rule grandfathers most prior ATF classifications and variants thereof, including “box-type” or externally

powered weapons, into the new definition of “frame or receiver” along with examples and a diagram of those weapons. The Department also declines to adopt the suggestion allowing qualified defense importer and manufacturer licensees to opt out from the proposed rule and proceed with their processes under the existing regulatory requirements. The GCA, 18 U.S.C. 925(a), does not exempt the manufacture of firearms for the government from the licensing, marking, and other requirements imposed on manufacturers. It only exempts the transportation, shipment, receipt, possession, or importation of firearms sold or shipped to, or issued for the use of, the government. Otherwise, unmarked, untraceable firearms manufactured for the government could be lost or stolen without any ability to trace them if later involved in crime.

h. Definition of “Partially Complete, Disassembled, or Inoperable Frame or Receiver”

Comments Received

Commenters opposed to inclusion of partially complete frames or receivers in the proposed definition of frame or receiver stated that the proposed rule would be difficult, if not impossible, to enforce. They opined that there is no purpose in trying to “ban 80%” receivers or regulate partially complete receivers because the rule is easily undercut by 3D-printing technology and the availability of online tutorials, which will only become more available and affordable for the public over time. One commenter, for example, stated that, even if all unfinished, or “80%,” receivers were taken away, firearms could still be made through other means, citing the FGC9 as an example. Because the commenter believes that technology undercuts the rule, the commenter argued that the new definitions and marking requirements serve no purpose and should not be adopted.

Commenters also had several questions about the terms used in the definition of partially complete frame or receiver such as what it means for an item to cross the critical line to where it “reach[es] a stage of manufacture where it is clearly identifiable as an unfinished component part of a weapon.” Other commenters asserted that the definition lacks objectivity and there are no objective metrics to guide the factors that are listed. With the proposed changes, the commenters questioned the meaning of “functional state.” Similarly, although ATF stated in the preamble that unformed blocks of

metal or articles in a primordial state “without more” would not be considered a partially complete frame or receiver, commenters stated that it is still unclear when these items fall under the definition where, for example, there were instruction booklets, metal working tools, or tutorial videos, because the definition hinges on what “without more” means, which ATF did not explain.

Manufacturers also raised concerns because they purchase partially machined raw materials or receiver shells without drilled fire control holes from domestic and foreign sources that are not current licensees. The manufacturers were concerned that the proposed rule would subsequently require their suppliers to obtain an FFL license, apply the markings, and keep A&D records, which would be very costly and disruptive. Another commenter suggested that “critical stage of manufacture” should be amended to say: “when the article becomes sufficiently complete to function as a frame or receiver.”

Department Response

The Department disagrees with commenters who stated that inclusion of partially complete frames or receivers in the proposed definition of frame or receiver would be difficult, if not impossible, to enforce. The proposed and final rule both make clear that a partially complete frame or receiver must have reached a stage of manufacture where it is clearly identifiable as a component part of weapon to be classified as a potential frame or receiver. Such articles have been regulated for importation and exportation since at least 1939.<sup>120</sup> With regard to 3D-printed PMFs, this rule explains that, as technology progresses, PMFs are likely to make their way to the licensed community because firearms licensees are likely to market them for sale, accept them into pawn, or repair them through gunsmithing services. Additionally, the GCA requires out-of-State firearm transfers to go through licensees, and some States require firearm sales or transfers to be conducted through licensees.<sup>121</sup>

However, the Department agrees with commenters that the supplement to the

<sup>120</sup> See footnote 78, *supra*.

<sup>121</sup> See 18 U.S.C. 922(a)(5); Cal. Penal Code 27545; Colo. Rev. Stat. 18–12–112(2)(a); Conn. Gen. Stat. 29–36(f), 29–37a(e)(2); D.C. Code Ann. 7–2505.02(a); Del. Code. tit. 11 1448B(a); 430 ILCS 65/3(a–10); Md. Code, Public Safety 5–204.1(c)(1); Nev. Rev. Stat. 202.2547(1); N.J. Stat. Ann. 2C:58–3(b)(2); N.M.S.A. 30–7–7.1(A)(2); N.Y. Gen. Bus. Law 898(2); Or. Rev. Stat. 166.435(2); 18 Pa. C.S.A. 6111(c); Vt. Stat. Ann. tit. 13, 4019(b)(1); Va. Code An. 18.2–308.2:5(A); Rev. Code Wash. 9.41.113(3).

proposed definition of “frame or receiver” entitled “partially complete, disassembled, or inoperable frame or receiver” should be revised to provide more guidance on the application of the definition. In the final rule, the Department has: (1) Removed the definition of “partially complete” as it modified the term “frame or receiver” and, instead, has expressly excluded from the definition of “frame or receiver” forgings, castings, printings, extrusions, unmachined bodies, or similar articles that have not yet reached a stage of manufacture (e.g., unformed blocks of metal, liquid polymers, or other raw materials) where they are clearly identifiable as an unfinished component part of a weapon; (2) made related clarifying amendments, such as changing the term “inoperable” to the more accurate term “nonfunctional,”<sup>122</sup> and expressly stating that the section includes frame or receiver parts kits that are designed to be—or may readily be—completed, assembled, restored, or otherwise converted to a functional state; (3) explained the meaning of the term “functional state” to be a frame or receiver that houses or provides a structure for the primary energized component of a handgun, breech blocking or sealing component of a projectile weapon other than a handgun, or internal sound reduction component of a firearm muffler or firearm silencer, as the case may be; and (4) included detailed examples of what would and would not be considered a “frame or receiver” that may readily be completed, assembled, restored, or otherwise “converted” to a functional state. Thus, as the proposed rule explained, articles that are not clearly identifiable as component parts of a weapon cannot be considered frames or receivers. *See* 86 FR at 27729. And even articles that are clearly identifiable as a partially complete, disassembled, or nonfunctional frame or receiver of a weapon are not frames or receivers under the new definitions unless they are designed to function as a frame or receiver, or may readily be completed, assembled, restored, or otherwise converted to do so.

The Department disagrees with the comment that the supplement should be amended to say that a frame or receiver means one that has reached a stage in

<sup>122</sup> “Nonfunctional” is more accurate because, although the weapons in which they are incorporated are “operated” by a shooter, frames or receivers are not operated by a person. Rather, frames or receivers are better described as “functional” or “nonfunctional” in that they may or may not be in a state of completion where they can house or hold the fire control components that allow the shooter to operate the weapon.

manufacture “when the article becomes sufficiently complete to function as a frame or receiver.” The GCA does not explain when an article becomes sufficiently complete to be a frame or receiver. As stated previously, to determine when a frame or receiver is created, this rule is guided by the definition of “firearm” in section 921(a)(3)(A), the definition of “machinegun” in 26 U.S.C. 5845(b), and relevant case law interpreting when a weapon “may readily be converted to expel a projectile by the action of an explosive” and “can readily be restored to shoot.”<sup>123</sup> This rule adopts these statutory concepts and case law so that ATF’s regulations more plainly indicate that a clearly identifiable component part of a weapon becomes a frame or receiver when it may readily be completed, assembled, restored, or otherwise “converted” to function as a frame or receiver, *i.e.*, to house or provide a structure for the primary energized component of a handgun, breech blocking or sealing component of a projectile weapon other than a handgun, or internal sound reduction component of a firearm muffler or firearm silencer, as the case may be.

#### i. Definition of “Destroyed Frame or Receiver”

##### Comments Received

A few commenters opined on the proposed definition of “destroyed frame or receiver,” which would not be considered a frame or receiver under the definition. Some stated that the definition for “destroyed frame or receiver” contradicts the definition for “partially complete, disassembled, or inoperable frame or receiver” because, according to the commenters, they are both in the same state as not being operable to create a working firearm and therefore ATF cannot regulate them as frames or receivers while also excluding them from the definition. Another commenter disagreed with ATF’s requirement that a cutting torch needs to be used to sever at least three critical areas of the frame or receiver to be an acceptable method of destruction. The commenter stated that, for polymer frames or receivers, simply cutting the frame or receiver in three critical areas should be enough because it could never be repaired by a reverse process and that a cutting torch is unnecessary to permanently destroy polymer frames.

##### Department Response

The Department disagrees that the definitional supplement concerning

<sup>123</sup> *See* footnotes 43 and 44, *supra*.

destroyed frames or receivers contradicts the supplement entitled “partially complete, disassembled, or inoperable” (now “nonfunctional”) “frame or receiver.” Under that supplement, a partially complete, disassembled, or nonfunctional frame or receiver is considered a “frame or receiver” if it is designed to, or may readily be converted to, expel a projectile by the action of an explosive. That supplement does not address destruction, which is addressed in the supplement entitled “destroyed frame or receiver.” A destroyed frame or receiver is one that has been permanently altered such that it may not readily be completed, assembled, restored, or otherwise converted to function as a frame or receiver. That supplement further explains how destruction may be accomplished—completely melting, crushing, or shredding the frame or receiver, or other method approved by the Director. The torch cut method in the proposed rule was cited only as one acceptable method, but it is not the only method.<sup>124</sup> To avoid confusion on this issue, the final rule replaces the stated methods with “or other method approved by the Director.”

#### j. Definition of “Readily”

##### Comments Received

Numerous commenters criticized the proposed definition of “readily,” which would be relied upon to determine, in part, if a partially completed frame or receiver falls under the definition of “frame or receiver” or if a weapon parts kit falls under the definition of “firearm.” The overwhelming concern raised was that the definition of “readily” is a nonexclusive list of numerous factors, none of which is controlling, and which includes subjective considerations that could leave it unclear to the industry and public when an item meets any particular definition. Commenters, for instance, explained that parts could be a firearm if an expert using specialized tools assembled it in ten minutes if ATF were to focus on the factors of time and ease; alternatively, those same parts assembled in that scenario might not be a firearm if ATF were to focus on the factors of expertise and equipment. Similarly, others argued that all the terms were impermissibly vague or

<sup>124</sup> *See* ATF, *How to Properly Destroy Firearms* (Aug. 14, 2019), available at <https://www.atf.gov/firearms/how-properly-destroy-firearms>; ATF Rul. 2003–1 (destruction of Browning M1919 type receivers); ATF Rul. 2003–2 (FN FAL type receivers); ATF Rul. 2003–3 (Heckler & Koch G3 type receivers); ATF Rul. 2003–4 (Sten type receivers).



arbitrary. For example, these commenters stated that “expertise” is wholly subjective and that ATF did not identify what knowledge or skills are essential to making a firearm.

One trade group stated that several major manufacturers communicated that as many as seven or more stages of a pistol’s receiver construction could be called into question under the proposed definition because it is not clear when a frame or receiver is “readily completed.” Each stage of the process, the group argued, could require serialization and recordkeeping. The group said that changing the standard of requiring serialization from only finished products to those that are “readily completed” is confusing to both manufacturers and their suppliers. Additionally, as mentioned above, manufacturers expressed concern that the products they receive from non-licensed third-party suppliers could fall under the definition of “partially complete.”

Various commenters argued that expansive definitions of “readily,” when applied to a partially complete frame or receiver, could result in steel or aluminum billets, castings, forgings, or even simple glass reinforced nylon raw materials being considered firearms. Numerous commenters focused on the factor of “time” under the proposed definition of “readily,” arguing that it is not an adequate factor, without more specificity, by which to measure if a weapon parts kit or partially completed frame or receiver may be readily convertible or assembled into a firearm. Commenters pushed back against ATF’s reliance on some of the court cases ATF cited as support for the factors to define the term “readily.” They stated several of the cases are from the 1970s and discuss a wide range of what constitutes readily convertible, ranging from 12 minutes, to 1 hour, to an 8-hour working day in a “properly equipped” machine shop. Thus, what one expert may accomplish easily in 20 minutes may require hours of hard work for a novice. One manufacturer, Polymer80, also critiqued ATF for not supplying a metric for time and for stating in a footnote that Polymer 80 assembly could be completed in under 30 minutes, leaving the company to wonder if 30 minutes is the standard. One commenter suggested that eight hours of work would be a reasonable threshold.

Some commenters believed that ATF’s own rulings and public statements in cases such as *California v. ATF*, mentioned above, contradict the notion that it is easy to finish lower receivers with simple possession of

hand tools in a way that would bring them under the definition of “frame or receiver.” Commenters argued that the process of converting an unfinished lower receiver into a finished lower receiver requires specialized equipment, precision tools, skill, and time. Users, according to the commenters, must purchase numerous parts and assemble them with care. Similarly, other commenters, under the assumption that an “80% lower receiver” would be included under the definition of partially complete frame or receiver, argued that this item “cannot fire blank cartridges, nor can it be ‘readily converted’ to do so,” because multiple holes have to be drilled and complex mechanical parts need to be attached. They stated that the AR–15 lower receiver is a “frame or receiver” once it becomes an integral component containing a fire control group and is attached via the takedown pins to the other components required to form a complete weapon in the AR–15 design pattern.

Others pointed out technological advances, such as CNC machines, that can convert metal ingots into a functional firearm, thus raising the question of whether a CNC machine sold alongside the ingots would be considered a firearm. Similarly, commenters questioned whether a 3D printer shipped with filament and files of 3D representations of firearms would constitute a firearm under the readily convertible test. Further, according to one commenter, in a “properly equipped” machine shop today, it would not be uncommon for the shop to acquire a three-axis CNC machine with a fourth axis trunnion for less than \$10,000 (Tormach PCNC 440 with microARC 4). Accordingly, the commenter argued that the existing case law upon which ATF relies does not serve to narrow and clarify the definition of “readily convertible.” Commenters asserted that no one can predict what “instructions, guides, templates, [and] jigs” the ATF Director will rely on in any given case. Commenters argued that ATF needs to remedy the definition with exact definitions of time, ease, expertise, equipment, availability, expense, and scope.

Other commenters noted that the term “readily” is used throughout the GCA in several contexts, including interstate transportation of firearms (18 U.S.C. 926A) and for the importability of firearms generally recognized as particularly suitable or readily adaptable for sporting purposes (18 U.S.C. 925(d)(3)). Commenters also noted that there are countless other uses

of the term “readily” throughout ATF regulations, such as in 27 CFR 478.92(a)(1)(i) (stating that “[t]he serial number must be placed in a manner not susceptible of being readily obliterated”), or in 27 CFR 479.131 (requiring that certain records be “readily accessible for inspection at all reasonable times by ATF officers”). The commenters asserted that ATF’s proposed definition will impact all these other places where the term “readily” qualifies certain provisions and that ATF’s proposed nonexclusive list of factors would not provide clarity in those contexts, either.

One commenter suggested that the term “readily” be removed from the proposed definition so it reads: “The term ‘frame or receiver’ shall include, in the case of a frame or receiver that is partially complete, disassembled, or inoperable, a frame or receiver that has reached a stage in manufacture where it is clearly identifiable by mechanical properties, material composition, geometry or function as an unfinished component part of a weapon. For purposes of this definition, the term ‘partially complete,’ as it modifies ‘frame or receiver’ means a forging, casting, printing, extrusion, machined body, or similar article.”

Other commenters questioned whether “solvent traps,” which they asserted are legitimate devices and sometimes resemble silencers, would be considered readily convertible under the new regulations. Although some individuals file an ATF Form 1 under the NFA to make solvent traps silencers, the commenters stated that persons using solvent traps as actual solvent traps should be allowed to transfer them across State lines without violating the GCA or becoming subject to the NFA.

#### Department Response

The Department disagrees that the term “readily” and the related nonexclusive list of factors when classifying firearms should be removed from the rule. As stated previously, the term “readily” has been adopted to determine when a weapon is considered a “firearm” under 18 U.S.C. 921(a)(1)(A), and also when the critical stage of manufacture has occurred in which an unfinished component part of a weapon becomes a “frame or receiver” under 18 U.S.C. 921(a)(3)(B). To explain the meaning of that term, this rule first sets forth a common dictionary definition of that term and then provides more clarity on how the term “readily” is used to classify firearms by listing relevant factors that courts have

adopted when making that determination.<sup>125</sup>

The Department disagrees that these factors should incorporate minimum time limits, percentages of completion, or levels of expertise, or otherwise create thresholds to determine when weapon or frame or receiver parts are “readily” converted. Enumerating in this rule how each of the factors would apply to the manifold designs and configurations of firearms and aggregations of firearm parts now in existence, or to those that may be produced in the future, would be difficult, if not impossible. However, the Department agrees that more clarity as to how the term “readily” is applied would help address commenters’ concerns. In the final rule, the Department: (1) Expressly excludes from the definition of “frame or receiver” unformed blocks of metal, liquid polymers, and other raw materials; (2) changes the term “inoperable” to the more accurate term “nonfunctional”; (3) expressly includes frame or receiver parts kits; (4) explains the meaning of “functional state”; and (5) provides detailed examples of when an unassembled or damaged frame or receiver, frame or receiver parts kit, or partially complete billet or blank, as the case may be, would be considered a “frame” or “receiver” because it may readily be completed, assembled, restored, or otherwise converted to a functional state. Although it would indeed be difficult, if not impossible, for ATF to provide examples of every possible state of completion or configuration of weapons or weapon parts, the proposed definition provides clarity on how the term “readily” is applied to the definition of “firearm,” and numerous courts have upheld the application of that term in related criminal and civil cases against constitutional vagueness challenges.<sup>126</sup>

The Department disagrees that application of the term “readily” in this rule will require manufacturers to serialize and record frames or receivers in each stage of the manufacturing process. First, the final rule expressly excludes from the definition of “frame or receiver” forgings, castings, printings, extrusions, unmachined bodies, or similar articles that have not yet reached a stage of manufacture where they are clearly identifiable as unfinished component parts of a weapon, such as unformed blocks of metal, liquid polymers, and other raw materials. Thus, it is not until articles have been fashioned into unfinished frames or

receivers that they are subject to the “readily converted” standard.

Manufacturers and importers should already know that these items have been regulated as “defense articles” for purposes of importation and exportation for many decades.<sup>127</sup> Second, as the examples in the final rule illustrate, only once a frame or receiver blank or billet is produced for sale or distribution must a determination be made whether the seller or distributor of the item or kit provides, or makes available to the purchaser or recipient of the item or kit, an associated template, jig, or tool that would allow the purchaser or recipient of the billet or blank to complete the frame or receiver fairly or reasonably efficiently, quickly, and easily. Companies that sell or distribute only unfinished frame or receiver billets or blanks, and not any associated jigs, templates, or similar tools to the same customer are *not* required to be licensed or to mark those articles with identifying information. However, companies that sell or distribute firearm parts kits, jigs, templates, or tools to the same customer with partially complete frames or receivers allowing them to be efficiently, quickly, and easily converted into functional weapons or functional frames or receivers must be licensed; must apply identifying markings to the partially complete frames or receivers; and must record them as firearms in their required records. Finally, under this rule, licensed manufacturers who receive non-firearm billets or blanks are not required to mark them until after the entire manufacturing process has ended for the complete weapon, or for the frame or receiver to be sold, shipped, or distributed separately, as the case may be—seven days in the case of GCA firearms and by close of the next business day in the case of NFA firearms.

The Department agrees with commenters who said that the term “readily” has other applications in the statute and regulations that have nothing to do with the enumerated factors. For this reason, the Department has made minor changes to this definition in the final rule to make clear that this term can apply to any process, action, or physical state, and that the listed factors relate only to firearm classifications, as follows: “A term that describes a process, action, or physical state that is fairly or reasonably efficient, quick, and easy, but not necessarily the most efficient, speediest, or easiest process, action, or state. With respect to the classification of firearms

under this part, factors relevant in making this determination include the following:”.

With regard to certain items marketed as “solvent traps,” the definition of “firearm silencer” in 18 U.S.C. 921(a)(24) means “any device for silencing, muffling, or diminishing the report of a portable firearm, including any combination of parts, designed or redesigned, and intended for use in assembling or fabricating a firearm silencer or firearm muffler, and any part intended only for use in such assembly or fabrication.” A so-called “solvent trap” that has been indexed for the purpose of allowing the end user to drill a hole for the passage of a projectile to diminish the report of a portable firearm is intended only for use in fabricating a silencer. It is, by definition, a “firearm silencer” without regard for the definition of the term “readily” or the application of the term “may readily be converted.”

#### k. Definition of “Complete Weapon”

##### Comments Received

Some commenters argued that ATF’s definition of a “complete weapon” is illogical because it includes “a firearm that contains all component parts necessary to function as designed whether or not it is assembled or operable.” They objected to the inclusion of operability, stating that, if it is inoperable, it is not a weapon. They also objected to inclusion of an unassembled weapon, as they believed this inclusion would create tremendous enforcement uncertainty. Commenters asserted that law-abiding gun owners who legally own both AR rifles and pistols could be charged with a felony if they store their firearms unassembled. Other commenters stated that the definition of “complete weapon” only generates confusion because, in their view, a “firearm” would legally be a “firearm” whether or not it is a “complete weapon” under the NPRM.

##### Department Response

For the reasons previously discussed, the Department disagrees that inoperable or nonfunctional firearms are not “weapons,” and that the application of the definition of “firearm” to unassembled weapons creates enforcement uncertainty.<sup>128</sup> Firearms manufacturing is a continuum from raw material to a functional item, and the term “complete weapon” is needed to explain *when* the frame or receiver of a weapon in the process of being manufactured must be identified and recorded as required by the regulations.

<sup>125</sup> See footnote 43, *supra*.

<sup>126</sup> See footnote 79, *supra*.

<sup>127</sup> See footnote 78, *supra*.

<sup>128</sup> See Section IV.B.3.h, *supra*.

Specifically, under this rule, frames or receivers of non-NFA weapons that are in the process of being manufactured as part of complete weapons may be marked and recorded by a licensed manufacturer up to seven days after the entire manufacturing process for the complete weapon has ended. Complete NFA weapons, consistent with the recordkeeping requirement in 27 CFR 478.123(a) and Form 2 submission requirement in 27 CFR 479.103, must be marked by close of the next business day after manufacture. Such complete weapons may be sold in an unassembled configuration or may be inoperable due to poor workmanship or design. But the fact that a complete weapon is sold or distributed unassembled, or happens to be currently inoperable, does not remove the requirement for identifying markings to be placed on the frame or receiver.

The term “complete weapon” is also used in the rule to explain that frames or receivers and other parts defined as “firearms” that are not component parts of a complete weapon at the time they are sold, shipped, or disposed of must be marked with all required markings within the specified time limits from completion so they can be traced if lost or stolen. The term is also needed to explain what it means to “conspicuously” mark firearms with serial number and other marks of identification. Markings must be unobstructed by other markings when the complete weapon is assembled.

#### I. Definition of “Privately Made Firearm”

##### Comments Received

One organization stated that the definition of PMF, which does not include firearms made prior to October 22, 1968 (unless remanufactured after that date), does not distinguish between a commercially made pre-1969 firearm and those made privately. The organization stated that sometimes one cannot tell if a firearm has had its serial number defaced or removed. As a result, according to the organization, dealers will decline to transfer or sell a firearm with no serial number without regard to whether it is a PMF. Further, an individual may or may not know, or can be wrong or mislead a dealer about, whether a particular weapon is a PMF or just an old firearm. Other commenters objected on grounds that thousands of gun owners who bought or made firearms before 1969 would become criminals because there is no way to tell if the firearms, which do not have serial numbers, were made before or after 1969.

##### Department Response

The Department agrees that the exclusion for pre-October 22, 1968, firearms from the definition of PMF does not distinguish between firearms that were commercially manufactured from those that were privately made because that definition refers to firearms produced by persons licensed under the GCA on or after that date. *See* 18 U.S.C. 921(a)(10) (defining “licensed manufacturer” as a person licensed under the provisions of chapter 44 of title 18). To make this clear, the final rule adds the term “manufactured” to that exception. However, the Department disagrees that the pre-October 22, 1968, exclusion from the definition of PMF raises concerns because it is not difficult for licensees to know if a firearm, whether or not it is a PMF, was manufactured or made prior to October 22, 1968. First, pre-October 22, 1968, firearms in circulation generally have some marks of identification. PMFs, by definition, are not marked with a serial number placed by a person licensed as a manufacturer under the GCA at the time the firearm was produced. Regulations implementing the Federal Firearms Act of 1938 required all firearms manufactured after July 1, 1958, to be identified with the name of the manufacturer or importer, a serial number, caliber, and model. *See* Internal Revenue Service, Department of the Treasury, 23 FR 343 (Jan. 18, 1958). The only exception from marking the serial number and model requirements was for shotguns and .22 caliber rifles not subject to the NFA. *Id.* at 346. Thus, the name of the manufacturer and caliber would still be marked on all commercially produced weapons, even though this subset of GCA firearms may not display a serial number or model (though some will). Second, there are few firearms in circulation manufactured prior to 1969 that were not commercially produced. As the rule explains, only in the past few years has technology advanced to allow individuals to quickly and easily make their own firearms for personal use from parts kits or 3D printers. Third, if a person is in doubt about whether a particular firearm without any markings was manufactured or made prior to October 22, 1968, there are many licensee and nonlicensee experts who can evaluate the firearm and provide an expert opinion, including as to whether the serial number on the firearm has been altered or obliterated. Additionally, persons may voluntarily seek a determination from ATF as to whether a particular firearm is subject to

regulation using the procedure provided in this rule.

#### m. Definition of “Importer’s or Manufacturer’s Serial Number”

##### Comments Received

A few commenters stated that the new definition of “importer’s or manufacturer’s serial number,” which requires more information than under the current regulatory scheme, is confusing. They stated the term “identification number,” which is part of the definition of “importer’s or manufacturer’s serial number,” is not a defined term, though it seems to be referring to what the industry understands to be an identification number. They pointed out the term “serial number” is interchangeably used throughout the NPRM in different sections to mean both the identification number and the newly defined term.

##### Department Response

The Department agrees with these commenters that clarification should be made to the definition of “importer’s or manufacturer’s serial number.” First, the Department recognizes the confusion that could be generated because the proposed definition of “importer’s or manufacturer’s serial number” stated: “When used in this part, the term ‘serial number’ shall mean the ‘importer’s or manufacturer’s serial number,’” while other parts of the proposed marking requirements in §§ 478.92 and 479.102 used the term “serial number” to also refer to a number that would be placed after an FFL’s abbreviated license number. For this reason, the final rule clarifies the definition by defining it as the serial number placed by a licensee on a firearm, including any full or abbreviated license number, any such identification on a privately made firearm, or a serial number issued by the Director. It also specifies that, for purposes of 18 U.S.C. 922(k) and 27 CFR 478.34, the term shall include any associated licensee name or licensee city or State placed on a firearm. The inclusion of the serial number and the associated licensee’s information as part of this definition means that these markings are protected by 18 U.S.C. 922(k), which prohibits possession of a firearm with a removed, obliterated, or altered serial number.

Because licensees have the option of marking the frame or receiver with either (1) a serial number and the manufacturer’s or importer’s city and State, or (2) a serial number beginning with its abbreviated license number and its name (or recognized abbreviation),

the final rule also makes minor changes in §§ 478.92(a) and 479.102(a). Specifically, in clarifying how a serial number may begin with an abbreviated license number as a prefix, these sections use the term “unique identification number” to properly describe the identifying information that would follow an FFL’s abbreviated license number or an identification number placed by the maker of a PMF. Further, the rule also makes clear that the identification markings (including any unique identification number) must be “legible,” meaning that they must use exclusively Roman letters and Arabic numerals, or solely Arabic numerals.

Also, to avoid confusion in the regulations with the “serial number” marked on a firearm, the term “transaction number” was substituted for “serial number” when explaining: (1) How Federal Firearm License numbers are assigned in § 478.47(a); and (2) how ATF Forms 4473 may be ordered and recorded in §§ 478.122(b), 478.123(b), and 478.125(e). This will ensure that the sequential number stated on the FFL or Form 4473 will not be confused with the “serial number” marked on a firearm. Future versions of Form 4473 will reflect this change to the regulations.

#### n. Definition of “Gunsmith”

##### Comments Received

Several commenters who identified as gunsmiths expressed concern about ATF Ruling 2010–10 being superseded upon the effective date of the final rule. ATF Ruling 2010–10 allows Type 01 gunsmiths to perform various services for manufacturers and importers without needing to mark the firearm (or frame or receiver) per 27 CFR 478.92. The commenters stated that, once Ruling 2010–10 is superseded, gunsmiths would have to apply for a Type 07 manufacturer’s license if they want to continue performing services for manufacturers. One custom gunsmith of 1911s provided an example of how the process of marking frames would be overly complex, if not impossible, to comply with if Ruling 2010–10 were to be superseded. First, the frame (*e.g.*, a 1911 frame) would have the original manufacturer’s marking; then, as the builder of the custom pistol, the commenter would place his company’s markings on the frame or receiver; then the markings of the Type 07 licensee that provides the checkering would be applied; and finally the markings of the Type 07 licensee that provides the specialized finish would be applied. These commenters asked that ATF

reconsider superseding Ruling 2010–10 or provide an exemption to allow custom gunsmiths and firearms manufacturers to use each other’s services in the manufacturing process without a requirement to mark, provided that the frame or receiver, as machined, is marked and compliant before the outside service is provided.

Similarly, one manufacturer said the proposed definition of gunsmiths is underinclusive because it would allow gunsmiths to perform their services “on existing firearms not for sale or distribution by a licensee.” The manufacturer stated that the proposed change would preclude some Type 01 licensed gunsmiths from continuing to perform manufacturing activities on the manufacturer’s behalf because those firearms will ultimately be intended for sale and distribution by the manufacturer. The manufacturer stated that this will impact several production lines at all of its primary manufacturing facilities. Another commenter stated that the proposed change to “gunsmith” implies that a person who is not a gunsmith would be prohibited from engraving a serial number onto the firearm. He stated that, if a person makes a PMF, that person should be able to serialize it.

##### Department Response

The Department agrees that the new definition of “gunsmith” will result in the re-licensing of many gunsmiths as manufacturers when they are involved in the production of firearms for sale or distribution by licensees. This is because persons engaged in the business of manufacturing firearms (*i.e.*, frames or receivers or complete weapons) for the purpose of sale or distribution by completing, assembling, applying coatings, or otherwise making them suitable for use, are required to be licensed as manufacturers. *See* 18 U.S.C. 921(a)(10), (a)(21)(A), 923(a). This is made clear in the revised definition of “gunsmith” in the final rule.

Nevertheless, in light of commenters’ concern regarding the differences between gunsmithing and manufacturing, the final rule also makes clear that licensed dealer-gunsmiths are not required to be licensed as manufacturers if they perform gunsmithing services only on existing firearms for their customers or for another licensee’s customers because the work is not being performed to create firearms for sale or distribution. The firearm upon which the gunsmithing service was performed is merely being returned to the individual

from whom it was received.<sup>129</sup> These services may include customizing a customer’s complete weapon by changing its appearance through painting, camouflaging, or engraving; applying protective coatings; or by replacing the original barrel, stock, or trigger mechanism with drop-in replacement parts. Licensed dealer-gunsmiths may also purchase complete weapons, make repairs (*e.g.*, by replacing worn or broken parts), and resell them without being licensed as manufacturers. Likewise, under the final rule, licensed dealer-gunsmiths may make such repairs for other licensees who plan to resell them without being licensed as a manufacturer. They may also place marks of identification on PMFs they may purchase and sell, or under the direct supervision of another licensee in accordance with this rule.

These activities are distinguished from persons who engage in the business of completing or assembling parts or parts kits; applying coatings; or otherwise producing new or remanufactured firearms (frames or receivers or complete weapons) for sale or distribution. Such persons must be licensed as manufacturers. *See, e.g., Broughman v. Carver*, 624 F.3d 670, 676–77 (4th Cir. 2010), *cert. denied*, 563 U.S. 1033 (2011) (licensed gunsmith who built and sold “custom” bolt action rifles by purchasing actions (receivers with internal parts) and barrels, fitting the barrels to the actions, bluing the actions, and making and attaching wooden stocks, was required to be licensed as a manufacturer).

The Department also agrees that superseding ATF Ruling 2010–10 by this rule could be burdensome to licensed gunsmiths required to be licensed as manufacturers because they would now be required to place their own identifying marking on firearms already marked by a licensed manufacturer or importer. For this reason, this rule as finalized allows licensed manufacturers, including persons formerly licensed as dealer-gunsmiths, to adopt the serial number and other identifying markings previously placed on a firearm by another licensed manufacturer without a variance, provided that the firearm has not been sold, shipped, or otherwise disposed of to a person other than a licensee. This change will also reduce the potential for confusion by law enforcement when tracing a firearm

<sup>129</sup> As noted in the NPRM, this rule, consistent with § 478.124(a), does not require completion of an ATF Form 4473 or NICS background check when a PMF is marked as a firearm ‘customization’ when it is returned to the person from whom it was received. 86 FR at 27731.

involved in a crime if multiple markings were to be found on those firearms. Under these circumstances, there is a reduced concern that a trace could not be successfully completed because the required records maintained by those licensees would reveal a continuous acquisition and disposition of that firearm.

However, once a firearm is sold, shipped, or otherwise disposed of to a person other than a licensee, the trace can be completed only to the first retail purchaser. After that point, it is difficult to trace the firearm to another licensed manufacturer that may have purchased it for remanufacture and resale or redistribution without the purchaser's own identifying markings. For this reason, the final rule distinguishes between licensee adoption of markings on new firearms from those that were already introduced into commerce to nonlicensees, such as those that are being remanufactured or imported. Additionally, the final rule also allows licensed gunsmiths and licensed manufacturers that conduct gunsmithing activities to adopt the existing markings on firearms when they engage in gunsmithing activities on firearms that are not for sale or distribution. These changes will thereby supersede ATF Rulings 2009–5 and 2010–10. Further, the final rule expressly clarifies that licensed manufacturers and importers, which are permitted to act as licensed dealers without obtaining a separate dealer's license (*see* 27 CFR 478.41(b)), can perform adjustments or repairs on firearms for their customers without recording an acquisition, provided the firearm is returned to the person from whom it was received on the same day.

Finally, with regard to PMFs, the Department agrees that licensed dealer-gunsmiths and other licensees that accept PMFs into inventory should be allowed to adopt a unique identification number placed by a nonlicensee if that identifying number otherwise meets the marking requirements. This allowance is reflected in the final rule. However, those licensees would still be required to place their abbreviated license number as a prefix (followed by a hyphen) to the existing serial number so that the firearm can be traced to them. Overall, the Department believes these provisions of the rule as finalized will mitigate the marking burden on licensees and make it easier for them to purchase and sell PMFs while maintaining traceability for law enforcement.

#### 4. Concerns With Marking Requirements for Firearms

##### a. Information Required To Be Marked on Firearms

###### Comments Received

Numerous commenters, including retailers and manufacturers, objected to the new marking requirements on multiple frames or receivers or on PMFs, arguing that the requirements would be too burdensome and confusing. Several manufacturers raised questions about what would be required of them. Some expressed confusion as to whether manufacturers and importers are to mark multiple parts of a single weapon with different serial numbers or if they are to mark separate components of a single weapon with the same serial number. Others asked if manufacturers of a present split or modular firearm configuration would continue to mark only the part they presently mark or if the NPRM would require them to mark more than one part until they receive a classification.

Another manufacturer observed that, if a single firearm will have two or more frames or receivers, the manufacturer will produce and serialize them as separate parts, at different times, in different production lines. Each separate part will be a separate “firearm,” and the serial number on each will duplicate the serial number on other(s) until they are put together. These separate “firearms” may sit in different bins until assembled, all the while continuing to have duplicate serial numbers, thus violating the regulation against duplicate serial numbers. *See* 27 CFR 479.102(a)(1). There is also a risk, the manufacturer stated, that frames or receivers with different serial numbers could be mixed up during production or distribution, or even by the end user, resulting in firearms with two different serial numbers. At least one manufacturer did not understand why the rule would require manufacturers to mark the caliber and model on more than one frame or receiver if, in the alternative, this marking could otherwise appear solely on the barrel or pistol slide (if applicable).

Another manufacturer stated that, although it is technically possible to serialize more than one part, for a small manufacturer to coordinate all of these components into batches for the various models and configurations with machine-engraved numbers would be challenging and very expensive. The manufacturer pointed out that, if all items are marked in advance and any one part fails a quality control process, it would lose the value of all three

components and the manufacturer's scrap costs would increase significantly.

Commenters asserted that, in the case of modular-type weapons, such as existing AR–15s, owners would be required to place serial numbers on parts that did not previously require them or would be prevented from swapping out upper and lower receivers, which is commonly done by firearms owners. Similarly, another commenter said that, without limiting the fire control components, videos show that 16 items in a typical Glock semiautomatic pistol would each be considered a frame or receiver and thus each part would need to be serialized and tracked. Others asked if there would be a controlling serial number for the firearm in the event that serialized parts are exchanged and a firearm has more than one serial number.

Additional commenters worried that the new definitions and marking requirements make transfer and background checks of firearms very confusing and potentially costly. Commenters argued that, even if a consumer thinks that he or she is purchasing only one firearm, the reality is that a firearm with numerous serial numbers would need separate background checks, which in some States would mean additional fees. Further, others argued that this would create a mess for recordkeeping and trigger multiple sales reporting. They stated that, if a firearm has multiple frames or receivers, each part with a different serial number is a “firearm” unto itself. They questioned whether an FFL selling this type of firearm(s) would list several serial numbers on the ATF Form 4473 or whether the consumer would have to fill out more than one ATF Form 4473. In these types of scenarios, they questioned whether an FFL would be required to file a multiple handgun sales report or for—those retailers in the States of Texas, New Mexico, Arizona, and California—fulfill the multiple rifle reporting requirement. Others argued that the NPRM did not address States where residents are limited to purchasing one handgun a month. They argued that, if a firearm has multiple frames or receivers, each of which is a firearm by law, then individuals could be prevented from buying a handgun in States with these limitations.

Another issue that several commenters raised is that they would not be able to fit all the new information on certain parts that will now be considered frames or receivers. For example, they stated that the NPRM requires serial number of an internal or drop in chassis frame or receiver (*e.g.*,

P320-type) to be unobstructed to the naked eye. The commenters said it is unclear how a manufacturer can safely place a lengthy abbreviated FFL number and the other requirements in the “window” of the polymer frame pistol so that the required information is visible. They stated that the inability to fit the new marking requirements is even more acute on smaller pistols or on certain curio and relic bolt action firearms.

Another manufacturer said that it would need to design and acquire dozens of new molds to fulfill the new requirements for marking and that a typical mold costs approximately \$100,000. The manufacturer stated it also would need to essentially modify all molds for polymer grip frames with the expanded marking requirements (such as by measuring from the flat surface of the metal and not the peaks or ridges, and by ensuring the markings are not susceptible to obliteration). This manufacturer also inquired how FFLs are supposed to measure the depth of markings after certain coatings are applied. Assuming the grip frames and trigger assemblies will be frames or receivers under the NPRM, the manufacturer stated that it would have to modify each grip frame or trigger assembly to include a metallic plate suitable for marking a serial number, which would increase the costs for itself and suppliers of these parts, and also require it to obtain a marking variance.

With regard to the content of the markings, one commenter wrote that the preamble of the NPRM contemplates that the new marking requirement could be satisfied by solely marking the licensee’s name and RDS code plus a unique number (“RDS+”) and that the RDS+ would satisfy the unique “serial number” requirement. The commenter expressed confusion because the preamble indicates that the RDS+ suffix could include alphabetic characters, but the rule, despite defining “legibly,” seems to limit the suffix to numerals only, as the rule uses the term “number” in several sections, such as § 479.102(a)(1). The commenter indicated that the contradictory information between the explanation in the preamble and the regulatory text itself is problematic because almost all manufacturers use alphabetic characters in their serial numbers. Other commenters pointed out that a modular lower can have its caliber changed and that, absent an upper, there is no way a manufacturer can mark a weapon with its caliber. They stated that the caliber should not be required on modular type weapons. They also asserted that requiring the caliber to be marked

would be futile because owners can simply change the caliber by replacing the upper.

#### Department Response

As stated previously, the Department agrees with numerous commenters that there should be only one “frame or receiver” in a given weapon or device. The Department has, therefore, added a new definition of “frame or receiver” in 27 CFR 478.11 and 479.11, as described herein, that focuses on one housing or structural component of a particular fire control or internal sound reduction component for a given weapon or device. Because of these revisions, there would almost always be one unique serial number marked on any such weapon or device, even if the components of a split or modular weapon were removed and reassembled using different components. To ensure that industry members and others can rely on ATF’s prior classifications, almost all classifications and variants thereof have been grandfathered into the definition of “frame or receiver.” Frame or receiver designs that have been grandfathered under the definitions may continue to be marked in the same manner as before the effective date of the final rule. This change should address concerns raised by manufacturers that their costs would increase in order to mark their existing frames or receivers with the new marking requirements or to record multiple markings in connection with complete weapons or complete muffler or silencer devices, and by retailers that would have been required to run more background checks for more items classified as the “frame or receiver” under the rule as proposed.

In response to comments on the content of the markings, the Department agrees with the comment that there could be confusion in the regulatory text as to the “number” that must be marked after the RDS Key, described in the rule as the licensee’s abbreviated Federal firearms license number. For this reason, the regulatory text has been amended to change the word “number” to “unique identification number” in §§ 478.92(a) and 479.102(a), where appropriate, to ensure that this particular marking is part of the “serial number” in that scenario. The unique identification number may include both alphabetic and numeric characters as stated in the definition of “legibly.”

The Department disagrees with the comment saying that caliber or gauge should not be a required marking for split or modular weapons. Information concerning the caliber or gauge of a weapon is useful to distinguish between

firearms during a trace or when matching projectiles to a particular weapon found at a crime scene. To mitigate the problem raised by commenters that a modular weapon’s caliber can change, the final rule makes clear the model designation and caliber or gauge may be omitted if that information is unknown at the time a frame or receiver is sold, shipped, or otherwise disposed of separately from the complete weapon or complete muffler or silencer device.

#### b. Markings on “Split or Modular Frames or Receivers”

##### Comments Received

Some manufacturers asked how they would handle warranty repairs of a modular or split receiver firearm under the NPRM if one of the marked parts must be replaced to make the firearm safe to use. They stated that a manufacturer would not be able to provide a replacement part because it cannot reuse the serial number or return the firearm with unmarked component(s) that are now considered to be the frame or receiver. If they did, the replacement part would be marked with a different serial number, placing the manufacturer in violation of section 923(i) of the GCA. They also asked if disassembly (*e.g.*, routine cleaning or replacement or repair of a part ATF would classify as frame or receiver) would constitute removal of the manufacturer or importer serial number in violation of 18 U.S.C. 922(k).

##### Department Response

Unlike the proposed rule, this final rule does not require multiple parts of a split frame or receiver to be marked (*i.e.*, only the upper receiver of a split receiver rifle need be marked, unless the lower is the grandfathered part). Thus, non-serialized parts of a split frame or receiver may be replaced without violating section 923(i). However, the final rule explains that similar modular subparts of a “multi-piece frame or receiver” (*e.g.*, two similar left and right halves of a frame or receiver) must be marked with the same serial number and associated licensee information. If one of those parts is removed and replaced with an unserialized part, then the possessor would violate section 922(k) for possessing a firearm with a removed serial number. However, the final rule sets forth a process by which a marked modular subpart of a non-NFA multi-piece frame or receiver may be removed and replaced without violating section 922(k). The replacement modular subpart must be marked by its manufacturer with the same original

serial number and associated licensee information, and the original part must be destroyed prior to such placement.

More specifically, under 18 U.S.C. 923(i) and 26 U.S.C. 5842(a), ATF has the authority to prescribe by regulations the manner in which licensed manufacturers and importers (and makers of NFA firearms) must identify a serial number on the frame or receiver of a weapon. Because multi-piece frames or receivers may be partitioned into similar modular subparts that could be produced and sold separately, each subpart must be identified with the same serial number and associated licensee information so that the frame or receiver, once complete (assembled or unassembled), can be traced to its manufacturer. The serial number identified on each subpart must be the same number so that the complete frame or receiver does not have a serial number duplicated on any other firearm produced by the manufacturer. Once the modular subparts are aggregated as a complete multi-piece frame or receiver, a modular subpart identified with the serial number cannot be removed and replaced unless the destruction procedure set forth in this rule is followed. *See* 18 U.S.C. 922(k); 27 CFR 478.34 (prohibiting possession or receipt of a firearm that has had the importer's or manufacturer's serial number removed); *see also* 26 U.S.C. 5861(g), (h) (prohibiting removal of the serial number or possession of an NFA firearm from which the serial number has been removed).<sup>130</sup>

#### c. Size and Depth of Markings

##### Comments Received

Another issue raised by commenters is the feasibility of doing an engraving to meet the new size specifications. One organization stated that, currently, the print size and depth limitations pertain only to serial numbers and not the additional information (*i.e.*, manufacturer's or importer's city or State). The proposed change to require that the serial number and additional information be engraved to a minimum depth of .003 inches and in a print size no smaller than 1/16 inch, per the proposed § 478.92(a)(i)(iv), would

<sup>130</sup> *Cf. United States v. Nixon*, 166 F.3d 1216, 1998 WL 739897, at \*3 (6th Cir. 1998) (table) ("The fact that the entire serial number or other indications of the serial number on the weapon were not obliterated fails to negate the fact that a portion of the serial number had been obliterated."); *United States v. Frett*, 492 F. Supp. 3d 446, 4552 (D.V.I. 2020) ("[T]he Court holds that a firearm bearing multiple serial numbers, only one of which is removed, 'has had the importer's or manufacturer's serial number removed, obliterated, or altered' within the meaning of Section 922(k).").

assertedly make it difficult or impossible to comply.

##### Department Response

The Department agrees with this comment, and as stated in the preamble of the proposed rule, this rule would not change the existing requirements for size and depth of markings. Consequently, the text of this paragraph in the final rule is amended to clarify that only the serial number and any associated license number must be in a print size no smaller than 1/16 inch.

#### d. Period of Time To Identify Firearms

##### Comments Received

Some commenters were concerned that the seven-day time limit in the proposed rule for qualified manufacturers to identify NFA firearms contradicts existing law because ATF Form 2, Notice of Firearms Manufactured or Imported, must be filed by the close of the next business day after manufacture, pursuant to 27 CFR 478.103. *Accord United States v. Walsh*, 791 F.2d 811, 818 (10th Cir. 1986) ("The registration procedure for manufactured firearms contained in the Treasury regulation does not provide additional time within which to place a serial number on a firearm."). One of these commenters was also concerned that the term "active manufacturing process" for purposes of applying the seven-day time limit was vague because a suppressor may be functional in some capacity even if the manufacturer is waiting for additional baffles to replace damaged or incorrectly manufactured parts that were previously produced.

##### Department Response

The Department agrees with these commenters that the proposed seven-day time limit to mark NFA firearms is inconsistent with the "close of next business day" filing requirement for ATF Form 2, which must include the serial number of the firearms manufactured. For this reason, the final rule makes clear that weapons and parts defined as "firearms" only under the GCA, but not the NFA, must be identified not later than the seventh day following the date the entire manufacturing process has ended for the weapon (or frame or receiver, if disposed of separately), or prior to disposition, whichever is sooner. Weapons and parts defined as "firearms" produced under the NFA must be marked by close of the next business day. In this way, the marking requirements under the GCA or NFA will be consistent with their applicable recordkeeping requirements, while providing reasonable grace periods in

which to identify firearms after the entire manufacturing process has ended.

The Department also believes that the phrases "actively awaiting materials" and "completion of the active manufacturing process" should be made clearer in the final rule. For this reason, the final rule no longer uses the term "actively awaiting materials" and instead establishes a presumption that firearms awaiting materials, parts, or equipment repair to be completed are, absent reliable evidence to the contrary, in the manufacturing process. The final rule also substitutes the phrase "completion of the active manufacturing process" for "the entire manufacturing process has ended" in determining the applicable time limit to identify firearms.

#### e. Marking "Privately Made Firearms"

##### Comments Received

Numerous commenters objected to the requirement that PMFs be serialized. Many believed that the proposed rule would require makers of PMFs that are non-NFA weapons to serialize their firearms and emphasized that it should be optional, not required, for a person to serialize the person's own guns. They asserted that holding private individuals to the same standards as commercial or corporate FFLs is unreasonably burdensome. Others pointed out that most PMFs are made from polymer or plastic and that there is no way to insert a piece of metal, which would be required per the proposed regulations, unless they go to a dealer or gunsmith and pay for extensive modifications. Commenters also said that forcing dealers to mark PMFs with their license information simply because a PMF owner took a firearm in for repair or upgrade is an added cost because the dealers will have to obtain additional equipment that is not needed for their daily operations and could be subject to liability if their FFL information is attached to a PMF. Commenters also asserted that PMF owners would not want their PMFs marked and that the rule would therefore prevent them from getting their PMFs repaired by FFLs or gunsmiths.

With respect to marking PMFs, commenters claimed that it would not be reasonable to expect an FFL retailer to know how to safely serialize a custom PMF because the safety of the firearm could be compromised if markings are placed in critical areas. Moreover, commenters said that many FFLs will not have the capability to mark firearms with serial numbers and thus would not be able to acquire and ship non-serialized PMFs to other dealers for

customers. Manufacturer FFLs and trade organizations similarly stated that PMFs are not subject to the same quality control as commercial arms and that FFLs would face more liability if they ran into problems adding a serial number to a customized PMF.

Other commenters discussed the burden associated with requiring PMFs to be marked any time one is received into inventory even if it is received for purposes limited to activities such as bore sighting or onsite adjustments at sporting events. The commenters stated that an FFL would not be able to perform a function test or other quick gunsmithing without first recording it in the A&D records and adding a serial number. Another commenter asked if an FFL would have to re-serialize a PMF if the PMF had already been marked with the private builder's own serial number. The commenter asserted it would be better for ATF to provide a best practices recommendation as to how FFLs may mark a PMF rather than making it a mandatory regulation. In addition, one commenter believed that one implication of the rule is that makers of PMFs would not be able to serialize their own PMFs because only FFLs would be able to serialize them.

Commenters also stated the marking requirement seems to require the use of laser, engraving, or CNC mill machines with engraving capabilities, given the mandatory depth and size requirements, which comments said could not be satisfied with simple and cheap engraving tools. Also, specifically with respect to PMFs, one FFL/SOT holder stated that metal plates on common polymer PMFs are often not large enough to engrave the proposed 10-plus character number to ATF size requirements. The suggestion from ATF in the NPRM that FFLs embed metal plates into PMFs, according to the commenter, does not comprehend the variety of materials—including epoxies, resins, ceramics, thermoset plastics, and well-known materials such as Bakelite—that do not allow for doing so.

A few commenters asserted that seven days is not sufficient time for FFLs to mark PMFs. Some argued there is no realistic way to mark a PMF in seven days because extra time would be needed to disassemble a completed PMF to mark it properly; or, if the FFL had no resources to engrave a serial number, then the FFL would have to send it out for marking, and it would be unlikely that the firearm could be marked within that time period if businesses that can do the marking have a backlog of work. Similarly, commenters argued that requiring FFLs to mark, or supervise the marking of, serial numbers of PMFs in

their inventory within a seven-day period would severely interrupt FFLs' ability to conduct such business and they would likely turn away unmarked PMFs to avoid these burdensome regulatory requirements. Others argued that the period of time should be extended to 21 days to account for delays, which could be caused by weather, fuel shortages, or shipper incompetence when shipping PMFs to another licensee, such as a gunsmith, for marking.

#### Department Response

As an initial matter, the Department notes that nothing in this rule requires private individuals to mark their personally made (non-NFA) firearms or to present them to licensees for marking. Nothing in this rule requires licensees to accept PMFs into inventory, mark PMFs with the name of the private maker, or record the maker's name as the "manufacturer" of the firearm. This rule requires only that PMFs voluntarily taken into inventory by FFLs be marked with a serial number prefixed with the licensee's abbreviated license number and for the FFL to record the acquisition information. This requirement allows the PMF to be traced directly to the licensee, not the private maker, if later used in a crime.

This rule explains in detail how accepting PMFs into inventory without serial numbers undermines the entire purpose of maintaining transaction records and other required records. For example, if multiple unmarked PMFs of the same "type" are accepted into inventory—each recorded only as a "pistol"—they would be indistinguishable from each other for tracing and other law enforcement purposes. Even if a PMF could be traced to a particular firearms licensee, there would be no information marked on that weapon that could be matched to a specific recordkeeping entry in either the acquisition or disposition book, ATF Form 4473, theft/loss report, or multiple sales report. For these reasons, PMFs must be marked with a traceable serial number like other firearms, but they do not need to be marked with the name of the private maker. As the proposed rule explained, PMFs would typically be marked by permanently embedding a metal plate into the polymer. 86 FR at 27732. Many, if not most, PMF parts kits already have a metal plate embedded into the partially complete frame or receiver for serialization purposes and to assist purchasers in complying with some State, local, or international

laws.<sup>131</sup> If a licensee does not have the capability to mark, the licensee can arrange for private individuals to have the PMFs marked by another person before accepting them, or, after acceptance, arrange for PMFs to be marked under the licensee's direct supervision with the licensee's serial number.

The Department also disagrees that metal serial number plates cannot be embedded or overprinted<sup>132</sup> into polymer materials, or that the serial number plates currently embedded within polymer frames or receiver are not or cannot be made large enough to be marked with at least 10 characters at the minimum 1/16-inch print size. The Department further believes that, as technology develops, it will become easier and cheaper for licensees to embed metal plates into polymer materials. Although, upon issuance of this rule, it may be difficult for licensees to mark some PMFs that they might have taken into inventory (*i.e.*, those without previously embedded serial number plates), the Department believes the final rule provides a sufficiently long grace period for them to mark or arrange for them to be marked by another licensee. Specifically, licensees will have from the date the final rule is published until 60 days after the effective date to properly mark and identify PMFs as required by the regulations.

Nonetheless, the Department agrees with some commenters that licensees, including dealer-gunsmiths, should be allowed to adopt a unique identification number previously placed on a PMF by a private maker that is not duplicated on another firearm of the licensee and otherwise meets the identification requirements of this section provided that, within the period and in the manner herein prescribed, the licensee legibly and conspicuously places, or causes to be placed, on the frame or receiver thereof the licensee's own

<sup>131</sup> The European Union (EU), for example, has issued a directive specifying how member countries are to mark polymer frames or receivers: "For frames or receivers made from a non-metallic material of a kind specified by the Member State, the marking is applied to a metal plate that is permanently embedded in the material of the frame or receiver in such a way that: (a) The plate cannot be easily or readily removed; and (b) removing the plate would destroy a portion of the frame or receiver. Member States may also permit the use of other techniques for marking such frames or receivers, provided that those techniques ensure an equivalent level of clarity and permanence for the marking." Commission Implementing Directive (EU) 2019/68 of 16 January 2019 Establishing Technical Specifications for the Marking of Firearms and Their Essential Components Under Council Directive 91/477/EEC on Control of the Acquisition and Possession of Weapons, annex.

<sup>132</sup> See footnote 69, *supra*.



abbreviated Federal firearms license number, which is the first three and last five digits, followed by a hyphen, before the existing unique identification number, e.g., “12345678-[unique identification number].” Again, these markings will allow the PMF to be traced to the licensee if later recovered at a crime scene.

Finally, the Department agrees with the comment that dealer-gunsmiths, as well as licensed manufacturers and importers, should be allowed to perform a function test and quick repairs on a PMF. For this reason, the final rule clarifies that licensed dealer-gunsmiths, manufacturers, and importers may conduct same-day adjustments or repairs on PMFs without having to place identifying markings or record the receipt as an acquisition or subsequent disposition upon return. This is not a significant change from the proposed rule because it provides consistency for same-day adjustment or repair by treating PMFs the same as commercially produced firearms in that they must be recorded in inventory only if repaired overnight. ATF has long maintained that, if a firearm is brought in for adjustment or repair where the person waits while it is being adjusted or repaired, or if the gunsmith is able to return the firearm to the person during the same business day, it is not necessary to list the firearm in the gunsmith’s A&D records as an “acquisition.”<sup>133</sup> If the gunsmith has possession of the firearm from one day to another or longer, the firearm received by the gunsmith must be recorded as an “acquisition” and then as a “disposition” in the gunsmith’s A&D records upon return to the same customer. However, the final rule makes clear that a PMF must be recorded as an acquisition whenever it is marked for identification, including same-day or on-the-spot. The only exception is when the firearm is marked by another

<sup>133</sup> See ATF Rul. 77–1 (holding that a firearm need not be entered into the bound A&D record if the firearm is brought in for adjustment or repair and the customer waits while it is being adjusted or repaired, “or if the gunsmith returns the firearm to the customer during the same business day it is brought in,” but noting that, if the “the firearm is retained from one business day to another or longer, it must be recorded in the bound acquisition and disposition record”); ATF, *Does a gunsmith need to enter every firearm received for adjustment or repair into an acquisition and disposition (A&D) record?* (July 13, 2020), available at <https://www.atf.gov/firearms/qa/does-gunsmith-need-enter-every-firearm-received-adjustment-or-repair-acquisition-and>. This final rule clarifies ATF Rul. 77–1 by explaining that licensed manufacturers and importers, who may engage in the business as a licensed dealer without obtaining a separate license (see 27 CFR 478.41(b)), may also perform same-day adjustment or repair without an acquisition record entry.

licensee under the licensee’s direct supervision with the licensee’s serial number because the firearm has already been recorded as an acquisition.

#### f. Adoption of Identifying Markings Comments Received

Some commenters stated that the explanation in the NPRM’s preamble on the “Marking of Privately Made Firearms” indicated that FFLs must always mark PMFs upon acquisition even if the private maker has already added a serial number. Commenters stated that markings PMFs with a manufacturer’s name, location, and a unique serial number is equivalent to the markings of a commercial firearm and therefore the regulation should account for PMFs already so marked. Similarly, they raised questions about the effect of the proposed rule for NFA firearms that have been approved through an ATF Form 1 and already recorded in the NFRTR. They asked if the original markings, as done by the maker of the firearm and recorded in the NFRTR, can be adopted by the FFL that acquires the PMF. Others asked whether the new marking requirements would render owners of pre-1986 machineguns, short-barreled rifles, short-barreled shotguns, and any other weapons under the NFA noncompliant with the NFA, as many of these firearms have only the lower receiver serialized and not other parts that could be deemed a frame or receiver under the NPRM.

#### Department Response

The Department agrees with commenters who said that PMFs that were manufactured or “made” privately should be treated similarly to commercial firearms when they are received by FFLs. The Department therefore agrees that FFLs should be allowed to adopt a unique identification number on a PMF if it otherwise meets the marking requirements. This final rule allows such adoption as an exception. However, unlike commercially produced firearms, private makers are not required to maintain records of production and transfer, and, under the GCA, firearms involved in crime are traced to licensees, not private makers. For this reason, licensees wishing to adopt the unique identification number marked by a private maker on a PMF would still need to add their abbreviated license number as a prefix to the unique identification number so adopted. In that way, the firearm can be traced to a licensee.

With regard to privately made NFA firearms, the rule as proposed and finalized does not define the term “privately made firearm” to include NFA firearms that have been identified and registered in the NFRTR pursuant to chapter 53, title 26, United States Code, or any firearm manufactured or made before October 22, 1968 (unless remanufactured after that date) that were not required to be marked. Furthermore, as stated previously, this rule requires marking only of a single component and grandfathers all prior ATF classifications except for partially completed, disassembled, or nonfunctional frames or receivers, including parts kits, that ATF determined were not firearm “frames or receivers” as defined prior to this rule.

#### g. Marking of “Firearm Muffler or Silencer Frame or Receiver”

##### Comments Received

Numerous commenters asserted that silencers should not be regulated at all because they are used solely to protect a shooter’s hearing by reducing the sound levels of firearms and do not make a firearm any more dangerous or affect the function of a firearm other than managing recoil. Therefore, they argued, there should be no requirement to mark or serialize these devices. They stated that almost no crimes outside of Hollywood movies are committed while using silencers and that unnecessary paperwork, taxes, wait times, and regulations have deprived firearm owners from obtaining a simple device that could help them avoid hearing loss. Others pointed out that there are a number of silencers without an outer tube, such as the Q erector, and there is no clear way to fit such a device within the proposed rule. They recommended the rule be more flexible by allowing for serialization requirements to be determined by the model of the silencer.

The American Suppressor Association (“ASA”) referenced ATF’s current guidance to industry that “[t]he replacement of the outer tube is so significant an event that it amounts to the ‘making’ of a new silencer.” Accordingly, ASA pointed out that, under ATF’s current guidance, the new silencer needs to be marked, registered, and transferred in accordance with the NFA and GCA. ASA asserted that this current guidance is unsupported by statute and should be addressed in the NPRM. ASA opined that remaking the outer tube for a silencer does not constitute the making of a new silencer under the NFA when such remaking is: (1) Completed by the original manufacturer of the silencer in question;

and (2) the remade outer tube is marked with the same serial number as the replaced outer tube. ASA asked that ATF allow for the replacement of a silencer's outer tube in these instances and opined that the NPRM's new definition of "frame or receiver" for silencers is a perfect forum for ATF to announce and codify this reconsideration.

#### Department Response

The Department disagrees with comments that silencers should not be marked with serial numbers. Both the GCA and NFA regulate firearm mufflers and silencers as "firearms." 18 U.S.C. 921(a)(3)(C); 26 U.S.C. 5845(a)(7). The GCA and NFA require silencers, like other firearms, to be identified with a serial number, *see* 18 U.S.C. 923(i); 26 U.S.C. 5842(a), and they could not be registered in the NFRTR without a serial number. This rule sets forth when and how silencers must be serialized. It makes it easier for manufacturers, importers, and makers to place serial numbers by requiring only one part of a complete firearm muffler or silencer device (*i.e.*, the frame or receiver, as defined), to be marked and not the other silencer parts when transferred between qualified licensees for further manufacture or repair of complete devices.

With respect to modular silencers like the Q erector, the final rule makes clear that, in the case of a modular firearm muffler or silencer device with more than one part that provides housing or a structure for the primary internal component designed to reduce the sound of a projectile (*i.e.*, baffles, baffling material, or expansion chamber), the term "frame or receiver" means "the principal housing attached to the weapon that expels a projectile, even if an adapter or other attachments are required to connect the part to the weapon."

The Department also does not agree with the comment that the final rule should allow for the replacement of a silencer's outer tube by its SOT manufacturer when the original tube is destroyed, and the replacement is marked with the original serial number. Under the NFA, 26 U.S.C. 5841(b)-(c), each qualified manufacturer must register in the NFRTR *each* firearm it manufactures and notify ATF of such manufacture to effect the registration. ATF has taken the position that the replacement of a serialized outer tube, now defined as the frame or receiver, is such a significant manufacturing activity that it results in the manufacture of a new silencer for which notification is required. *See* ATF,

*National Firearms Act Handbook—Appendix B—Frequently Asked Questions—Silencers* at 175–76, available at <https://www.atf.gov/files/publications/download/p/atf-p-5320-8/atf-p-5320-8.pdf>. Additionally, unlike the return of an NFA firearm conveyed for repair, qualified manufacturers are required to pay transfer tax when a new silencer is transferred to an unlicensed person. *See* 26 U.S.C. 5811. Therefore, allowing manufacturers to create and return new NFA firearms, including silencers, without notification to ATF or payment of transfer tax would be contrary to law.

#### h. Firearms Designed and Configured Before Effective Date of the Rule

##### Comments Received

Numerous commenters expressed concern that the grandfathering provision regarding marking in the NPRM is unclear and that they would not know if the new marking requirements would be triggered without more clarity from ATF. Commenters pointed out that the NPRM says licensed manufacturers and importers may continue to identify the additional firearms (other than PMFs) of the same "design and configuration" as they existed before the effective date. They stated the use of "and" in this phrase indicates that both criteria must be met for the grandfathering clause to apply and thus they were uncertain when changes to a particular firearm model remove it from the grandfathering protection. One manufacturer stated that it routinely introduces new SKUs that differ from existing designs and configurations in minor ways. Likewise, others asked if a change in grip panels, barrel length, or fixed sights versus adjustable or red-dot capable sights would result in a change in design or configuration. Accordingly, they requested that ATF give clarity to the terms "design" and "configuration" as well as ensure that the current definition of frame or receiver is preserved for grandfathered firearms that will continue to follow the old marking requirements so as to avoid creating a third category of firearms that do not fit within either the old or new marking requirements. They also stated that they will face new burdens regarding future firearms designs and configurations without knowing the meaning of those terms.

One trade group that represents importers stated that ATF needs to clarify whether its grandfather provision for marking means that all previously manufactured models and configurations are not required to be

marked under the new requirements. Specifically, the group asked if firearms manufactured overseas before the publication of the rule, but imported afterwards, are exempt from the new requirements. If they are not exempt, the group stated, then an exemption should be drafted that allows the markings to be engraved on the barrel or slide when the receiver is too small to mark conspicuously. The group argued that simply allowing for this result by variances is inefficient.

Another FFL said the rule does not address whether a manufacturer is supposed to mark, or register as acquired, parts already in its physical inventory if those parts now meet the new definition of frame or receiver when those parts are used in the assembly of a complete firearm that is of a new design or configuration. The FFL also stated it is unclear what serialization information should be put on "newly" defined frame or receiver parts that are vendor supplied but already in its inventory. Alternatively, it said, if serialization is not required, then the rule should address whether a licensee would be required to place the unserialized firearms in its A&D records with a serial number of "No Serial Number" ("NSN"). The FFL further pointed to extraneous impacts of the proposed definition and marking requirements, noting that manufacturers use outside, non-licensed vendors to supply numerous firearm components, many of which could fall under the definition of frame or receiver, thus forcing these vendors to become licensees and meet the new marking and recording requirements.

#### Department Response

The Department agrees with commenters that the grandfathering of firearms should be clarified by ensuring that the current definition of frame or receiver is preserved for existing firearms and by clarifying the meaning of "design and configuration" in the proposed rule. In light of these comments, the final rule recognizes ATF's prior classifications identifying a specific component of a given weapon as "the" frame or receiver, including variants thereof, as falling within the new definition of "frame or receiver." Only ATF's prior determinations that a partially complete, disassembled, or nonfunctional frame or receiver, including a parts kit, was not, or did not include, a firearm "frame or receiver" as defined prior to this rule are excluded from the grandfathering clause. Such determinations include those in which ATF had determined that the item or kit had not yet reached a stage of

manufacture to be, or include, a “frame or receiver” under the existing definitions. Because this rule expressly regulates weapon and frame or receiver parts kits, and aggregations of parts with partially complete frames or receivers that are designed to, or may readily be converted to, expel a projectile, these prior ATF classifications (in which the entire kit may not have been presented to ATF at the time of classification) will need to be re-evaluated on a case-by-case basis.

To address confusion concerning the meaning of “new design and configuration,” the final rule retains the marking grandfathering provision, but revises the text to remove “and configuration” and defines “new design” to mean “that the design of the existing frame or receiver has been functionally modified or altered, as distinguished from performing a cosmetic process that adds to or changes the decoration of the frame or receiver (e.g., painting or engraving), or by adding or replacing stocks, barrels, or accessories to the frame or receiver.” The Department considered commenters’ concerns that the potential effect of the new rule to require new configurations of existing models to be marked under the new marking requirements would impose substantial costs (such as the cost of making new molds to conform with the new requirements) on existing product lines that are not otherwise being modified. ATF considered these comments in light of the public safety interest in ensuring appropriate markings. Because ATF has the capacity to successfully trace the many hundreds of thousands of grandfathered firearms and will be able to continue to trace them even if there is a change in configuration, the Department removed “and configuration.” The revised provision therefore allows manufacturers to mark the same information on the same component defined as a “frame or receiver” as they did before the effective date of the rule, which includes the specific component of a weapon or device (and variants thereof) that ATF classified as the frame or receiver before the rule becomes effective.

In regard to the comment on how the rule applies to new designs of firearms already in inventory, the final rule makes clear that the new marking requirements apply only to frames or receivers manufactured after the effective date of the final rule. This change will help accommodate changes in firearms technology while still ensuring that the frames or receivers with new modular designs are marked and can be traced. The new marking

information substantively differs from the current marking requirements for firearms (other than PMFs) only in that the licensee’s name, city and State, or, alternatively, the licensee’s name (or recognized abbreviation) and manufacturer’s or importer’s abbreviated FFL number, must be placed on the frame or receiver in addition to the unique identification number, and cannot be placed on the slide or barrel. The reason for requiring all this information to be placed on the frame or receiver is that the associated licensee information, when marked on the slide or barrel as currently allowed, can be separated from the serialized frame or receiver in limited circumstances, rendering the firearm untraceable. A unique identification number, or traditional serial number, on the frame or receiver alone may not be sufficient because ATF may not know which licensee produced the firearm or the location where the traceable records are located. Manufacturers may, however, seek a marking variance from the Director if they find it difficult to transition to these marking requirements for new frame or receiver designs.

#### i. Voluntary Classifications of Firearms and Armor Piercing Ammunition Comments Received

A few commenters said the way that § 478.92(c) is drafted does not obligate ATF to respond to a classification request, which could allow the agency to ignore a classification request and stall advancement of new products or technologies deemed politically undesirable. Commenters also noted that there is no requirement that the agency notify the submitter that the agency has accepted or rejected the classification request. Therefore, the commenters advocated that there should be a requirement that determinations be rendered within three months or that some other reasonable time-frame be added to the proposed 27 CFR 478.92(c). One commenter suggested adding language deeming the submitted product compliant as proposed by the requestor if ATF fails to respond within a specified time frame. It also recommended deleting, for purposes of flexibility, the prohibition on rendering a determination unless a firearm accessory or attachment is installed on the firearm(s) for which it is designed and intended to be used. Further, it proposed adding a sentence stating that an ATF determination is an opinion and does not have the force of law. Another commenter claimed that the codification of the classification letter process fails to abide by the Attorney General’s

memorandum entitled “Prohibition on Improper Guidance Documents.”

Commenters also said that it is unrealistic to believe that a manufacturer would have the ability to submit marketing or instruction materials with a classification request per the proposed rule, as oftentimes these materials are developed just before a product launches. They also questioned whether a prior determination becomes invalid if instructions or marketing materials change, thereby triggering submission of another request and reverting the product to the proposed rule’s default marking requirements pending a new determination. Other commenters argued that asking manufacturers to submit instructions and manuals is not only a huge administrative burden but also would lead to less production and fewer submissions of instructions, as it seemed possible that ATF could use the guides against the manufacturers. The lengthy waits and delays that manufacturers already face under the current process, according to the commenter, would only be compounded under the NPRM. All this would have the unintended consequence of creating a disincentive for manufacturers to develop new, safer, and more reliable firearms because of a heavy regulatory burden.

Some commenters further opined that ATF’s classification process allows the agency to play favorites, pick technologies, and influence court decisions without going through the APA. They asserted that the proposed rule actually incentivizes technical developments that will create an even worse black market of untraceable firearms.

One commenter suggested altering the last sentence of proposed 27 CFR 478.92(c), to state that ATF classifications of frames or receivers issued after publication of the final rule are not considered authoritative with regard to other samples, designs, models, or configurations of frames or receivers. Adding this language, the commenter said, would allow a licensee to leverage a previous hardware determination and make it more transparent to industry that a previous hardware determination is an acceptable practice if the design was in existence prior to the publication date of the final rule.

#### Department Response

The Department agrees with commenters that the rule, as proposed, would have resulted in more voluntary classification requests to ATF to determine which part of a new design

of a firearm was “the” frame or receiver. This would have increased the burden on both licensees and ATF. The Department agrees with commenters that the statute is best read to focus on a single portion of a weapon as “the” frame or receiver. Accordingly, the Department establishes a new definition of “frame or receiver” as described to focus on a single portion of a weapon for “frames” of handguns; “receivers” for rifles, shotguns, and projectile weapons other than handguns; and “frames” or “receivers” for firearm muffler or silencers. The final rule does not adopt the proposed definitional supplement entitled “Split or Modular Frame or Receiver.” The Department agrees that not finalizing this provision will substantially reduce or eliminate the need for persons to submit classification requests to ATF to help them determine which portion of a weapon is the frame or receiver of a particular model.

With regard to other types of firearm classification requests, ATF has long accepted voluntary requests in furtherance of its mission to assist persons in complying with the requirements of the GCA and NFA as a public service. There is no statutory requirement for a person to submit such requests and likewise no requirement for ATF to act upon any such requests. Alternatively, anyone may seek private counsel to determine the person’s legal obligations under the Federal firearms laws and regulations.

The Department disagrees with the suggestion to eliminate, for flexibility, the provision that states that the Director shall not issue a determination regarding a firearm which may be sold or distributed with an accessory or attachment unless it is installed on the firearm(s) in the configuration for which it is designed and intended to be used. The accessory or attachment itself must be attached to the weapon so that a proper firearm classification can be made under the GCA or NFA.

The Department disagrees with the suggestion to add a sentence to individual ATF firearm classifications saying that the classification is an opinion that does not have the force of law. Firearm classifications are private letter rulings issued to a particular requestor with respect to a specific item. Saying that ATF classification letters do not have the force of law may mislead the requestor into believing that the statutes and regulations referenced therein, or possible administrative actions taken by ATF (e.g., one saying that the firearm cannot be returned because it would place the recipient in violation of law), are not required to be

followed. The GCA and NFA, and their implementing regulations, clearly have the force and effect of law. Should a requestor ignore the classification letter and move forward to produce and sell or import items classified as firearms in violation of the GCA or NFA, the classification letter could be used to prove the willfulness of the violation in a criminal prosecution, administrative licensing or tax collection proceeding, or for seizure and forfeiture of unlawfully produced or possessed weapons.

The Department also disagrees with the comment that codification of the classification letter process fails to abide by the memorandum of the Attorney General entitled “Prohibition on Improper Guidance Documents” (Nov. 16, 2017), not only because classification letters are not “guidance documents,” but also because that memorandum was rescinded by the Attorney General by memorandum dated July 1, 2021, consistent with the President’s Executive Order entitled “Revocation of Certain Executive Orders Concerning Federal Regulations” issued on January 20, 2021.<sup>134</sup>

The Department agrees with the comment that it may be burdensome for requestors to submit instructions, guides, and marketing materials with a classification request if those materials are not available at the time of submission. However, as explained in the rule, these items and materials are important for ATF to determine whether an unfinished, disassembled, or nonfunctional item or kit is a “firearm” subject to regulation under law. When sold or distributed with a partially complete, disassembled, or nonfunctional item or kit, they must be submitted. The final rule mitigates this burden by excluding from this requirement submission of such items and materials with firearm samples that are complete and assembled.

The Department also agrees with the comment that the requestor of a voluntary classification of a specific component as a frame or receiver should be able to rely on that classification for other models and configurations the requestor manufactures. For this reason, the final rule makes clear that: (1)

Determinations made by the Director identifying the specific component of a weapon as the “frame or receiver” as defined are applicable to variants thereof; and (2) an ATF classification of a specific component as the “frame” or “receiver” is applicable to or authoritative with respect to any other sample, design, model, or configuration of the same weapon so that the requestor does not need to submit additional requests for future variants. In addition, defining the term “frame or receiver” in a more limited manner in the final rule will reduce or eliminate the need for industry members to voluntarily request a classification from ATF when deciding which particular component of a weapon is the frame or receiver, thereby reducing manufacturing costs.

#### 5. Concerns With Recordkeeping Requirements

##### a. Acquisition and Disposition Records Comments Received

Several FFLs stated they would have problems with recordkeeping and inventory if there is more than one frame or receiver. They claimed that paperwork and tracking would be very burdensome because parts swapping and replacements would result in multiple inventory entries. Likewise, many industry members asserted that serialization of multiple frames or receiver parts would create recordkeeping “havoc.” One commenter offered a hypothetical: Assume that ATF determines that a receiver has three separate parts, each of which must be serialized, and assume all three parts are made by the same manufacturer. If receiver part A is made on March 1, receiver part B is made on September 5, and receiver part C is made on December 8, the commenter was unsure which date would be the date of manufacture if recorded in a single entry. Or, if the dates were recorded in separate entries, the commenter stated this would be alarming because there would be duplicate serial numbers recorded for one firearm. Finally, the commenter asked whether, when all three parts were finally assembled to make a full receiver, would that action require another record, and if so, what would be that date of manufacture.

Additionally, FFLs asserted it would be impossible to comply with the marking requirements because there is no compatible software they can use for recordkeeping and inventory. A major manufacturer stated that its current electronic business suite, which is responsible for tracking all parts and product inventory and for generating the

<sup>134</sup> See Memorandum for the Heads of All Department Components, *Re: Issuance and Use of Guidance Documents by the Department of Justice* at 1 (July 1, 2021), available at <https://www.justice.gov/opa/page/file/1403606/download> (defining “guidance document” as “a statement of general applicability” that does not include either “adjudicatory or administrative actions” or “rulings”); E.O. 13992, 86 FR 7049 (Jan. 20, 2021); see also *Processes and Procedures for Issuance and Use of Guidance Documents*, 86 FR 37674 (July 16, 2021) (revoking 28 CFR 50.26 and 50.27).

A&D records, is inherently incompatible with multiple serial numbers per firearm (whether matching or non-matching). It further stated it was not aware of a viable solution available to adapt this system in a way that would allow for tracking of multiple serial numbers per serialized item. This sentiment was echoed by several companies that highlighted the logistical problems with trying to keep track of multiple serial numbers on numerous frames or receivers.

Another major manufacturer stated it would take years to test and change its already highly customized software suite to comply with the rulemaking. Its systems, it said, are not equipped to (1) process or manufacture firearms with more than one serialized component; (2) serialize and track more than one component with the same serial number; (3) associate more than one serial number with a complete firearm the company otherwise acquires; (4) generate the required A&D records; or (5) “update” a serial number to reflect marking of a PMF. The company stated it could not comply with the proposed rule and explained how trying to comply would be costly and disruptive to its manufacturing lines. These types of cost estimates provided by various companies are described further below. See Section IV.B.13 of this preamble.

Manufacturers also pointed out an inconsistency between the proposed change to § 478.123(a), which would require manufacturers to record the serial number and other required information “not later than the close of the next business day following the date of manufacture or other acquisition,” and proposed § 478.92(a)(1)(v), which would require manufacturers to “identify a complete weapon . . . no later than seven days following the date of completion of the active manufacturing process, or prior to disposition, or whichever is sooner.” They asked how they can record the serial number and other information on a manufactured firearm by close of the next business day if it is not required to be identified for seven days from completion of its manufacture.

Other industry members raised concerns about recording and reconciling frames or receivers that could be “manufactured or acquired” prior to the time period in which the required markings must be applied. These types of firearms (e.g., a fully machined, unserialized frame or receiver) could be numerous, and it appeared to commenters that ATF expected manufacturers to list these firearms that have no identifying information with an “NSN” serial

number. This, according to commenters, would create difficulties because the manufacturer would have to keep track of unserialized parts in the A&D records and, if any of those firearms were destroyed prior to serialization, the manufacturer would have no way to identify which frame or receiver corresponded to each recorded NSN entry in the manufacturer’s records. Commenters worried that this would result in countless recordkeeping errors and that theft/loss reporting of unserialized parts would be exceedingly difficult if not impossible. One suggested that a clear statement be added in the final rule that frames or receivers need not be “acquired” by manufacturers prior to marking if the parts being used in the manufacturing process could address this concern. Similarly, commenters stated that ATF Ruling 2012–1, which provides a manufacturer seven days following the date of completion of a firearm (or frame or receiver) to be shipped or disposed of separately) to both mark and record the identifying information in its records, should be retained.

Several manufacturers contended that the “commercial record” exception in proposed § 478.123(a), which would exempt manufacturers from recording the manufacture or acquisition of a firearm no later than the close of the next business day so long as they held a commercial record with relevant information, is irrelevant and would never apply. They argued that a “commercial record” is a record of transaction between a transferor and transferee and that internal manufacturer records are not “commercial records.” Therefore, they argued, the exemption from the next day recording requirement and allowance of up to seven days would never apply. They made similar arguments that the “commercial record” exception would also not apply for repair or replacement requests, thus making it impossible to comply with the next day business rule. Accordingly, they requested that the current seven-day deadline be retained.

#### Department Response

Because the Department agrees with commenters that the definition of “firearm” in 18 U.S.C. 921(a)(3)(B) is best read to mean a single part of a weapon as being the frame or receiver, the final rule adopts three subsets of the proposed definitions of “frame or receiver”—“frame” for handguns and variants thereof; “receiver” for rifles, shotguns, and projectile weapons other than handguns and variants thereof; and “frame” or “receiver” for firearm muffler or silencer devices. The more

limited definitions adopted in the final rule should address the costs and software problems that commenters raised.

The Department also agrees with commenters who pointed out the inconsistency between the marking and recordkeeping requirements for manufacturers. The Department agrees that the time period should be the same and has clarified that markings be placed, and firearms be recorded, no later than the seventh day following the date of manufacture or other acquisition for non-NFA weapons and the frames or receivers of such weapons. Likewise, to be consistent with the recordkeeping and ATF Form 2 submission requirements, NFA weapons and parts defined as firearms must be marked and recorded, and Form 2 submitted, no later than close of the next business day after manufacture. The Department also agrees that the commercial record provision is not applicable to most manufacturers and that providing the seven-day grace period to both mark and record makes the commercial record allowance for non-NFA weapons that are manufactured unnecessary. For these reasons, that provision has been amended in the final rule to apply only to NFA weapons that are otherwise acquired commercially.

#### b. Recordkeeping for “Privately Made Firearms”

##### Comments Received

One manufacturer stated that it did not understand how FFLs are to record PMFs that are marked in accordance with State laws (e.g., Connecticut), which have different requirements for assignment and structure of a serial number.

##### Department Response

Under the final rule, the licensee marking the frame or receiver of a PMF must place the licensee’s abbreviated license number (also known as the “RDS Key”) as a prefix before the unique identification number originally placed by the maker of the PMF that will be adopted by the licensee. The adopted markings must otherwise meet the marking requirements. This requirement allows ATF to trace the firearm to a particular licensee. If a State has issued a unique number that must be placed on a firearm, then the licensee’s abbreviated FFL number would be added as a prefix to that number if the licensee is going to accept that firearm into inventory. Again, nothing in this rule requires a licensee to accept a PMF into inventory or to

mark (non-NFA) PMFs on behalf of unlicensed persons.

#### c. Record Retention Burden

##### Comments Received

Generally, commenters opposed the requirement that FFLs retain their records indefinitely until they discontinue their business, arguing that doing so would be burdensome and costly. Some pointed to the cost and burden on gunsmiths if many of them had to become licensees in order to mark PMFs. Those gunsmiths would then be subject to all the recordkeeping requirements imposed upon FFLs. Other commenters also expressed concern that having FFLs retain their records indefinitely would raise privacy concerns and subject FFLs to potential liability. FFLs, they argued, are subject to break-ins, both physical and cyber. Consequently, criminals could access ATF Form 4473s, use them to target unsuspecting firearms owners, and steal their firearms.

##### Department Response

The Department disagrees that the record retention rule is unreasonably burdensome; raises additional privacy concerns; increases the probability of break-ins; or exacerbates the deleterious effects of break-ins that do occur. At present, licensees are required to maintain their records of acquisition and disposition for at least 20 years. The Attorney General in this rule is exercising his authority under 18 U.S.C. 923(g)(1)(A) and (g)(2) to extend the 20-year retention period for licensees so that their records are not destroyed. The rule allows “closed out” paper records that are more than 20 years old to be stored in a separate warehouse, which would be considered part of the business or collection premises for this purpose and would be subject to inspection in accordance with 18 U.S.C. 923(g)(1) and 27 CFR 478.23. Alternatively, those paper records may be turned in to ATF if the licensee voluntarily chooses to discontinue its business or licensed activity for which those records were maintained, pursuant to 18 U.S.C. 923(g)(4) and 27 CFR 478.127, even if it subsequently obtains a new license.

With regard to persons who may become engaged in the business as gunsmiths so they can mark firearms, such persons have always been required by law to be licensed and maintain records of firearms they take into inventory for gunsmithing work, including engraving firearms.<sup>135</sup> This

rule clarifies that licensed gunsmiths do not need to be re-licensed as manufacturers for the sole purpose of engraving or otherwise marking PMFs. Additionally, in response to comments, the final rule reduces costs by clarifying that licensees may have firearms engraved on-the-spot by any person under the direct supervision of the licensee (*i.e.*, without the engraver taking the firearm into an inventory) provided the marking requirements are met.

#### d. Record Retention Impact on Public Safety

##### Comments Received

Some commenters argued that requiring FFLs to maintain their records indefinitely (instead of for the current 20-year period) serves no purpose. They asked ATF to produce evidence that there is a statistically significant number of instances where a crime involved a firearm purchased outside the 20-year window to justify the change; further, they doubted that Form 4473s from over 20 years ago would be helpful in solving crimes. Other commenters stated that sales records rarely help solve cases and claimed that tracing has been known not to work. Many challenged the usefulness in changing the retention of record requirement, stating that the average time-to-crime for recovered firearms is less than 10 years and that ATF and other entities have previously said that a firearm is untraceable after 5 years. At least one commenter opined that the retention period should be shortened to seven years.

##### Department Response

The Department disagrees with commenters who said that the record retention requirement serves no purpose. Firearms are generally durable weapons that last many decades, and their lethality and potential use in crime does not diminish over time. As explained in this rule, firearms have been traced to retailers who destroyed numerous records that were older than 20 years, but those traces could not successfully be completed. The National Tracing Center (“NTC”) conducted an analysis of all trace requests submitted between January 1, 2010, and December 31, 2021, that were closed under a particular code in the tracing system indicating the FFL specifically informed ATF that it did not have records for that firearm because the records were more than 20 years old and had been destroyed. A total of approximately 16,324 traces, or 1,360 on average per

year, could not be completed during this time period because the records had been destroyed. Of these total unsuccessful traces, approximately 182 of the traces were designated as “Urgent,” 1,013 were related to a homicide or attempted homicide (not including suicide), and 4,237 were related to “Violent Crime.” Further, with the advancement of electronic scanning and storage technology, maintaining old records is not as difficult or costly as it was when ATF first allowed records over 20 years old to be destroyed in its 1985 rulemaking. *See* 50 FR at 26702.

#### e. Alternatives to Record Retention Requirement

##### Comments Received

One commenter, who believed the extended recordkeeping to be a burden, stated that ATF needs to be consistent in its use of language. The commenter cited the difference in phrasing between § 478.129(b)—“until business is discontinued”—and § 478.129(e)—“until business or licensed activity is discontinued.” The commenter questioned the meaning of the latter phrase, asking if it refers to the actual closing down or the lapsing of a specific license. This could impact high volume dealers in their decision to either renew a current license or to allow it to lapse and apply for a new license, as a means of relieving the burdensome recordkeeping requirements. If ATF is purposefully using the different phrases, the commenter asked ATF to provide more clarity.

##### Department Response

The Department agrees with the comment that discontinuance of business includes cessation of “licensed activity” or lapse of a specific license, and that the language of proposed § 478.129(b) and proposed § 478.129(d) should have included the same language as paragraph (e). The final regulatory text has been amended accordingly.

#### 6. Clarity on Unlawful Conduct

##### Comments Received

Commenters objecting to the proposed inclusion of “weapon parts kits” in the definition of “firearm” expressed concern about the expansion of conduct that would be considered unlawful. In the NPRM, ATF explained it was clarifying that weapon parts kits are included under the definition of a “firearm” so that FFLs who sell these kits to unlicensed individuals would be required to complete the ATF Form 4473, background check, and recordkeeping requirements. 86 FR at

<sup>135</sup> *See* ATF Rul. 2009–1 (“Any person who is engaged in the business of . . . engraving firearms

. . . must be licensed as a dealer, which includes a gunsmith, under the Gun Control Act.”).

27726. ATF further explained in footnote 45 of the NPRM that persons engaged in the business of selling or distributing weapon parts kits cannot avoid licensing, marking, recordkeeping, or other requirements to which FFLs are subject “by selling or shipping the parts in more than one box or shipment to the same person, or by conspiring with another person to do so.” *Id.* at 27726 n.45.

Commenters claimed that individuals, producers, and retailers will be left guessing what constitutes a weapon parts kit because, in the commenters’ opinion, it was unclear from the proposed definition how many orders could constructively constitute a weapon parts kit over a period of time. They worried that a simple misstep, such as an individual selling components or tools that could be part of a weapon parts kit, could result in prison time if the individuals selling the components or tools could be viewed as having conspired with other dealers or manufacturers to sell a complete weapon parts kit.

#### Department Response

In response to some commenters who expressed confusion concerning footnote 45 of the NPRM, 86 FR at 27726, as to what conduct is acceptable with respect to the sale or distribution of weapons parts kits or aggregations of firearm parts, the Department reiterates that title 18 of the U.S. Code includes Federal felony violations that can apply to circumstances involving the final rule’s requirements. These include criminal prohibitions on: Engaging in the business of importing, manufacturing, or dealing in firearms without a license (18 U.S.C. 922(a)(1)(A)); engaging in the business of importing or manufacturing ammunition without a license (18 U.S.C. 922(a)(1)(B)); aiding and abetting or causing such conduct to occur (18 U.S.C. 2); and conspiring with another to engage in such conduct (18 U.S.C. 371).<sup>136</sup> Additionally, persons who manufacture and sell unassembled weapons or weapon parts kits in “knockdown condition” (*i.e.*, unassembled but complete as to all component parts) cannot structure transactions to avoid paying Firearms

<sup>136</sup> Further, under 18 U.S.C. 1715, except for customary trade shipments between licensees, firearms capable of being concealed on the person, including handgun frames or combinations of parts from which handguns can be assembled, are prohibited from being mailed by the United States Postal Service. 39 CFR 211.2(a)(2), (a)(3); United States Postal Service, *Publication 52—Hazardous, Restricted, and Perishable Mail* at sec. 432.2(d) (Oct. 2021), available at [https://pe.usps.com/text/pub52/pub52c4\\_009.htm](https://pe.usps.com/text/pub52/pub52c4_009.htm) (last visited Mar. 23, 2022).

Excise Tax on their sales price.<sup>137</sup> In sum, persons cannot undermine these requirements and prohibitions by working with others or structuring transactions to avoid the appearance that they are not commercially manufacturing and distributing firearms.<sup>138</sup>

#### 7. Stifles Technological Innovation Comments Received

Several commenters opposed the NPRM because they believed that it would discourage technological innovation and ignored the realities of the design and engineer process. Commenters stated that companies or new entrants to the market will generally manufacture in accordance with the “safe-harbored” products identified within the proposed definitions because they fear the risk of non-compliance and the resulting potential for liability.

#### Department Response

The Department disagrees that the rule will stifle innovation. Because of this rule, licensees will have a better understanding of which portion of a

<sup>137</sup> See 26 U.S.C. 4181 (imposing on the manufacturer, producer, or importer an excise tax of 10 percent (pistols and revolver) or 11 percent (other firearms) on the sale prices of firearms manufactured, produced, or imported, including complete, but unfinished, weapon parts kits); Rev. Rul. 62–169, 1962–2 C.B. 245 (kits that contain all of the necessary component parts for the assembly of shotguns are complete firearms in knockdown condition even though, in assembling the shotguns the purchaser must “final-shape,” sand, and finish the fore-arm and the stock); Internal Revenue Service Technical Advice Memorandum 8709002, 1986 WL 372494, at \*4 (Nov. 13, 1986) (for purposes of imposing Firearms Excise Tax it is irrelevant whether the components of a revolver in an unassembled knockdown condition are sold separately to the same purchaser in various related transactions, rather than sold as a complete kit in a single transaction); *cf.* Rev. Rul. 61–189, 1961–2 C.B. 185 (kits containing unassembled components and tools to complete artificial flies for fisherman were sporting goods subject to excise tax); *Hine v. United States*, 113 F. Supp. 340, 343 (Ct. Cl. 1953) (kits consisting of a fishing rod “blank” and everything necessary to complete a fishing rod were subject to excise tax having “reached the stage of manufacture or development where they became recognizable as . . . rods . . . even though there remained one or more finishing operations to be performed”). The Alcohol and Tobacco Tax and Trade Bureau of the U.S. Department of the Treasury should be consulted with respect to the imposition of Firearms and Ammunition Excise Tax. See U.S. Dep’t of the Treasury, *Manufacturers and Producers* (Apr. 17, 2018), available at <https://www.ttb.gov/firearms/manufacturers> (last visited Mar. 23, 2022).

<sup>138</sup> See, e.g., *United States v. Evans*, 928 F.2d 858, 859–62 (9th Cir. 1991) (affirming convictions for conspiracy to cause, and aiding and abetting, the possession of unregistered machineguns where one defendant sold parts kits containing all component parts of Sten machineguns except receiver tubes and the other sold customers blank receiver tubes along with detailed instructions on how to complete them).

weapon is the frame or receiver with respect to current and new designs and will be able to mark those firearms without seeking guidance from ATF. By providing much needed clarity as to what is a frame or receiver, ATF is encouraging innovation by providing a framework under which new ideas and technology can develop. With the advancement of split and modular firearm designs in which components may become separated, these updates are necessary to identify firearms for inventory control and to allow tracing. To alleviate the cost to add the associated licensee information on existing frames or receivers, the final rule requires only new designs (*i.e.*, those that are functionally modified or altered) to be identified with the associated licensee’s name, city and State, and serial number or, alternatively, the licensee’s name and the serial number beginning with an abbreviated license number as a prefix to the unique identification number. Again, under this final rule, there would be only one frame or receiver of a given weapon.

#### 8. Does Not Enhance Public Safety Comments Received

Thousands of commenters opposed the changes in the NPRM, arguing that the NPRM will not enhance public safety and that adding serial numbers will do nothing to reduce crime. Some commenters stated that ATF presented no evidence that definitively links firearm part serialization with statistically significant violent crime reduction and failed to show evidence that serialized firearms clearly assist in law enforcement investigations that result in the return of stolen or lost firearms.

Commenters opposed to the rule claimed that PMFs or “ghost guns” are not generally used by criminals because they are too expensive to build and that firearms make their way into the hands of criminals through theft or other activity. In the experience of at least one commenter, 3D printing of firearms can be a time intensive process where a single print of a handgun can take anywhere from 48 to 72 hours to finish. Further, it can take several tries to get a print done, which can take a period of several days. This time investment, in the commenter’s opinion, makes it less likely that criminals are using 3D printing to create firearms they intend to use in crimes.

Further, commenters wrote that, even if ATF required markings on PMFs, it is well known that criminals simply obliterate serial numbers. Numerous

commenters also pointed to ATF's Motion to Dismiss in the *California v. ATF* lawsuit, where the State of California asked the Federal court to direct ATF to vacate its determinations that unfinished pistol frames and receivers are not subject to the same regulations as other firearms and to direct ATF to classify so-called "80%" frames and receivers as firearms subject to Federal firearms statutes and regulations. Paraphrasing ATF's arguments from the agency's Motion to Dismiss, commenters stated that ATF argued "eight such crimes out of the 1.1 million violent crimes committed in the relevant six-year-period is a far cry from an overwhelming wave that would cause a State injury sufficient to confer standing . . . . Nor can California plausibly plead that those crimes would not have occurred with traditional, serialized firearms." Likewise, commenters also took issue with the data ATF presented in the NPRM regarding the 23,906 PMFs submitted for tracing from 2016 through 2020. They stated that ATF needed to provide context for the data it presented. They claimed the data presented is not sufficient to demonstrate that PMFs are actually used in crimes and that ATF has been able to argue only that "suspected" PMFs were "reported" to be present in "potential" crime scenes. Further, they opined that the PMFs recovered might actually involve hundreds of factory-made firearms with the serial numbers removed.

Other commenters countered ATF's data by citing a Bureau of Justice Statistics' ("BJS") publication to try to show that criminals do not use PMFs. See BJS, *Source and Use of Firearms Involved in Crimes: Survey of Prison Inmates, 2016* (Jan. 9, 2019), available at <https://bjs.ojp.gov/library/publications/source-and-use-firearms-involved-crimes-survey-prison-inmates-2016>. In that survey, 287,400 surveyed prisoners had possessed a firearm during their offense. Among these, more than half (56 percent) had either stolen it (6 percent), found it at the scene of a crime (7 percent), or obtained it off the street or from the underground market (43 percent). Most of the remainder (25 percent) had obtained it from a family member or friend as a gift. The report said only 7 percent of felons surveyed purchased their firearms legally through an FFL. In sum, commenters claimed that the NPRM is a solution in search of a problem and is not addressing an actual problem.

#### Department Response

As discussed in the Section II.A of this preamble, the submission of PMFs

reported for tracing by law enforcement is increasing at an exponential rate, especially over the last three years, which is more recent than the 2016 BJS data relied on by commenters. Further, unlike commercially produced firearms, it is difficult for licensees to account for PMFs in their inventories and to report thefts or losses of those weapons to law enforcement and insurance companies. The current technology for privately making firearms, including 3D printing, is continually improving, and the Department and ATF have the authority and obligation to promulgate regulations to implement the GCA in light of the public safety goals of that statute.

The Department disagrees that PMFs can statistically be compared to firearms that have undergone background checks, or with firearms recovered that have been marked with serial numbers and other identifying information. As explained in this rule, PMFs are being assembled from parts without background checks. They are not yet being acquired through the primary market in quantities like commercially produced firearms. But they are easily acquired by persons prohibited by law from receiving or possessing firearms, and they therefore pose a significant threat to public safety. Moreover, unlike other firearms recovered by law enforcement, PMFs are far more difficult for law enforcement to trace when recovered at a crime scene because they lack serial numbers and other identifying markings. With the advancement of firearms technology, PMFs will, over time, eventually make their way into the primary market as they become more reliable, and where they can be marketed broadly, pawned, or repaired.

#### 9. Tracing Efforts Hindered

##### Comments Received

Commenters asserted that the NPRM will not enhance public safety because the new requirements will only make it more confusing for law enforcement officers when tracing firearms. Commenters stated that criminals could simply acquire two copies of the same model and interchange or swap parts, which would send law enforcement on a wild goose chase. Other commenters stated that individuals typically swap out upper and lower assemblies to alternate calibers or to use different barrels, which would lead to more than one serial number on the firearm. In these cases, an officer may find two or three different serial numbers and submit all the numbers to ATF for tracing, which would require ATF to contact multiple manufacturers,

distributors, and retailers, and possibly multiple transferees who purchased firearms.

#### Department Response

The Department agrees with commenters who said that, under the proposed rule, law enforcement may find it more difficult to trace firearms with more than one serial number. For this reason, the final rule accepts commenters' suggestions asserting that the term "frame or receiver" should be defined to mean only a single housing with one unique serial number that is not duplicated on any other firearm. The Department agrees with commenters that doing so will be less costly for licensees to mark and record, and for law enforcement to trace firearms involved in crime. Therefore, the Department has defined the term "frame or receiver" to focus on only one part that is marked on a particular weapon or firearm muffler or silencer. In the case of a multi-piece frame or receiver, however, the final rule makes clear that, if there are two or more similar subparts that make up a multi-piece frame or receiver, then those subparts would be marked with the same serial number and associated licensee information. Thus, there should be very few circumstances in which there are more than one unique serial numbers placed on a weapon (*e.g.*, a remanufactured or imported firearm where the manufacturer or importer chooses to mark its own serial number rather than adopting an existing serial number).

#### 10. Punishes Law-Abiding Citizens

##### Comments Received

Numerous commenters objected to the NPRM because they believed it could turn law-abiding citizens into felons and would only serve to punish hobbyists who build their own firearms. Concerned that firearms in their possession would have more than one frame or receiver and therefore would need more than one part marked, commenters opposed to the rule expressed concern that they would be automatic felons once the regulation becomes effective. For instance, commenters stated that, if the upper for an AR-15 is considered a receiver under the rule, then thousands of law-abiding citizens who own these items would become felons overnight. Other commenters similarly questioned whether they will have violated the NFA or GCA if they sell or purchase an unmarked partially completed weapon parts kit after the final rule is enacted.



## Department Response

The Department disagrees that this rule turns law-abiding citizens into felons and only serves to punish hobbyists who build their own firearms. Nothing in this rule prevents unlicensed law-abiding citizens and hobbyists from making their own firearms by using commercially produced parts or by using 3D printers; or from transferring PMFs to others as long as they are not engaged in a business or activity requiring a license. If such persons wish to engage in the business of manufacturing, importing, or dealing in firearms, they must obtain a license like any other manufacturer, importer, or dealer. Of course, private makers must abide by the Undetectable Firearms Act, 18 U.S.C. 922(p); NFA requirements; and any applicable State and local laws that govern privately made firearms. With regard to commenters' assertion that there would be more than one "frame or receiver" on a given weapon, this final rule does not define that term in a manner that would result in more than one on a particular weapon.

## 11. Impacts on Underserved and Minority Communities

### Comments Received

Numerous commenters asserted that the NPRM is racist and would negatively impact the poor and minority communities. They requested that the rule either be rescinded or that a "racial equity analysis" be conducted to prevent any racially discriminatory outcomes. These types of commenters stated, for example, that the requirements for serial numbers will disproportionately impact the poor, elderly, and minorities and will place the nation's citizens at increased risk from criminals. Other commenters stated their belief that the rule will result in more Black Americans being arrested, prosecuted, and incarcerated and thus will harm already vulnerable communities. Another commenter contended the proposed rule is at odds with the President's equity initiatives in that, although the Administration is considering equity in pursuing policy changes to education, employment, and housing, this policy of promoting equity should also include "firearms equity." The commenter indicated that increased costs to gun manufacturers under this proposal would not only affect small businesses but also would have a disparate impact on low-income citizens, who are disproportionately persons of color, according to the commenter. Accordingly, the commenter stated that ATF must provide data and a comprehensive

analysis to prove that the NPRM does not unfairly and inequitably penalize any racial or ethnic group, nor harm any protected civil rights class. Further, the commenter argued that ATF should seek to increase gun affordability for low-income citizens and increase gun ownership among disadvantaged people.

### Department Response

The Department disagrees that additional racial equity analysis needs to be conducted on the rule or that this rule is inconsistent with equity initiatives of the Administration. This final rule implements the GCA, which regulates commerce in firearms. The GCA, in part, requires that all firearms manufactured, imported, and sold by FFLs, or transferred through FFLs, be marked with serial numbers in order to be traceable wherever those firearms are recovered by law enforcement nationally or internationally. A firearms trace provides an investigative lead to law enforcement regarding the identity of the unlicensed person who first purchased the firearm from a firearms retailer (or at retail from a manufacturer, importer, or wholesaler); the identification of that person does not automatically indicate that the person is a criminal. The GCA does not distinguish between communities in the United States; further, ATF is prohibited under Federal law from maintaining a registry of firearms or firearms owners, *see* 18 U.S.C. 926, with the exception of weapons subject to the NFA, and therefore ATF does not know who owns firearms, nor does it keep track of who builds their own PMFs. Accordingly, there is no way for ATF to anticipate or measure now or in the future how the rule would impact particular communities based on racial or socioeconomic distinctions. Lastly, it is not within the scope of the GCA, or the Department's or ATF's purview, to increase gun affordability for low-income citizens and increase gun ownership among any particular group of people. For additional information, *see* Section IV.A.5.h of this preamble.

## 12. Other Priorities and Efficiencies

### Comments Received

Many commenters stated that the Department and ATF should not attack law-abiding citizens but should instead focus on real criminals and enforce the existing firearms laws. They stated that ATF should expand resources in the investigation and assistance of prosecution of weapons charges and more fully advise the courts on such technical issues. Other commenters

stated that the government should devote resources to solving mental health issues or combating drugs on the street. Other commenters suggested that the government propose new sentencing guidelines for individuals who steal or utilize firearms in criminal activities rather than enact new rules that impact only law-abiding citizens.

### Department Response

The Department agrees with commenters that mental health and drugs are important issues for the government to address, but disagrees that this rule improperly diverts ATF resources. To the contrary, the rule is absolutely necessary to allow ATF to focus its resources. The rule accomplishes this goal by helping to ensure that firearms recovered from crimes can be traced through licensee records using the information marked on the frame or receiver of each firearm. Not only do more traceable firearms lead to increased discovery and prosecutions of criminals, but they also provide ATF with key crime gun intelligence, such as firearm trafficking patterns through multiple sales reports, demand letters of licensees with a short "time-to-crime," and theft/loss reports.<sup>139</sup>

## 13. Concerns With the Economic Analysis

### a. Addressing an Externality

#### Comments Received

In the NPRM, ATF stated that this rule would address externalities. 86 FR at 27738. Commenters stated that externalities result from inefficiencies in market transactions. Commenters stated that ATF failed to address how criminals produce a negative externality by using an unmarked weapon when committing a crime. In addition, commenters stated that commercial activity should not be held responsible for any difficulties ATF experiences in enforcing Federal law.

#### Department Response

ATF concurs that this rule would not address externalities due to market inefficiencies; therefore, to avoid any confusion, the language in the NPRM that suggested that this rule would address a market inefficiency has been removed in the final rule. Regardless of this change, publication of this rule remains necessary to enforce the GCA and NFA.

<sup>139</sup> *See* footnotes 33 and 39, *supra*.

## b. Overall Costs

## Comments Received

Many commenters stated that the costs that ATF attributed to the rule did not account for the full number of PMFs currently in circulation. They stated that there are as many as 20 million individuals or PMFs that would be affected by this rule. In addition, one commenter suggested that the overall cost estimate in the NPRM (which the commenter calculated to be seven cents per firearm for all firearms currently in circulation) was not a realistic cost estimate given the comprehensive changes being made to the industry as a whole. One commenter suggested that a low estimate of \$45 to mark each firearm should make the overall cost estimate over \$100 million. Another commenter believed that the increased cost to the consumer of five dollars per firearm is too low because this cost includes engraving, paperwork retention, legal services, and engineering, all of which would be necessary to achieve compliance with the new regulations. Several commenters stated that the 20-year estimate of \$1.1 million is too low. One commenter stated that, if an “80%” receiver or frame sells for \$100, the \$1.1 million estimate would mean that only 550 receivers or frames were sold per year—a number the commenter believed was “impossibly low.” Commenters asserted that companies would suffer substantial losses or go out of business altogether. One commenter asked if businesses would be compensated if their actual costs were above the costs estimated in the rule.

Some commenters suggested that requiring multiple serial numbers would also be cost prohibitive for manufacturers and make the rule economically significant. A commenter suggested that the manufacturing costs alone would be at least \$400 million. Many commenters stated that ATF failed to compile data on unfinished receivers and kit sales and that ATF does not know how commerce would be affected by the rule change. One commenter stated that, to comply with new regulations, companies would need to seek legal advice and train employees on the regulations and form changes, which would exceed the cost estimate of \$10 per company.

One commenter wanted to know if ATF had considered how higher demand for determinations would affect the agency and the manufacturers awaiting these determinations. Additionally, this commenter wanted to know if ATF had considered the costs to Federal, State, and local agencies to

train law enforcement to recognize items now classified as firearms and the increased workload on ATF to regulate firearms with multiple frames or receivers.

One commenter stated that some individuals must drive long distances to reach an FFL. These trips are expensive and time consuming. Another commenter stated that the cost estimate for individuals was too low because it failed to consider the time and transportation costs of travel to an FFL to transfer parts, such as upper receivers or pistol slides, which the commenter believed would be required to be serialized under the rule.

## Department Response

ATF agrees that the costs of the rule did not account for PMFs currently owned by law-abiding individuals, but this is because the rule does not affect individuals in possession of PMFs unless the individual tries to sell or otherwise dispose of the PMF through an FFL. ATF cannot agree with the commenter that there may be up to 20 million PMFs in private circulation because ATF does not maintain any data that would allow for an estimate of the number of PMFs. In any event, PMFs, by definition, are not serialized by FFLs and would only need to be serialized if the individual with the PMF transfers it to an FFL. Nonetheless, ATF significantly revised its economic analysis in preparing the final rule to better reflect the rule’s impact on these affected populations.

Where feasible, the Department has reduced some of the burdens on the regulated community. Rather than requiring multiple serial numbers, the final rule amends the proposed definition of “frame or receiver” to identify one part of a firearm to be the “frame” or “receiver” that requires a serial number (with the exception of multi-piece frames or receivers that are composed of multiple modular subparts, which require placement of the same serial number and associated licensee information on those parts). Because there will almost always be one serial number per firearm under the final rule, no Federal, State, or local costs were considered for law enforcement to review firearms with multiple serial numbers.

ATF concurs with the comment that entities will need to provide training to employees to ensure compliance when any new regulations are published. However, ATF disagrees that these costs should be considered under the rule. Activities such as training employees and obtaining legal opinions in response to a new regulation of this type are

usual activities for complying with the regulatory requirements in this industry and are not treated as new costs associated with the rule. Where manufacturers have been granted determination letters for their firearm designs, these designs have been grandfathered to be excluded from the final rule, except for those determinations that a frame or receiver had not reached a stage of manufacture to be classified as a frame or receiver. Due to these changes and the revised definitions under the final rule, ATF does not anticipate that manufacturers and retailers of currently regulated firearms will incur significant costs from the publication of this final rule.

## c. Affected Populations

## Comments Received

One commenter suggested that ATF underestimated the overall number of the affected populations because the number of public comments received on the proposed rule was more than the number of affected entities listed in the NPRM. One commenter stated that the total affected population should include all businesses that sell firearms components, not just makers of unfinished frames or receivers. One commenter stated that ATF failed to include “micro-scale” businesses that specialize in firearms customization for marksmanship competitions, and that many small businesses that sell semiautomatic pistol slides and accessories, which they believed would be reclassified as firearms by the final rule, would need to become licensed as dealers or manufacturers.

Many commenters stated that the Regulatory Impact Analysis (“RIA”) did not account for the costs incurred by individuals. Many commenters estimated a total number of PMFs already in circulation and estimated that the cost for those currently in circulation would be millions of dollars. Some commenters stated that the NPRM should have included an estimate of the number of PMFs and unfinished receivers that would be reclassified as firearms. Multiple commenters stated that there were millions of firearms produced prior to 1968 that are not serialized and that requiring application of a serial number to these firearms would lower their value.

Commenters estimated that approximately 300 million firearms would need to be serialized under the rule and that the time frame to serialize these firearms under the proposed rule would be unreasonably short. Other commenters estimated approximately 3 million PMFs would need to be marked

under the rule. For these PMFs, they estimated the costs for associated marking and transfer fees to be \$180 million dollars.

#### Department Response

ATF disagrees that the number of entities affected by the rule is the same or similar to the number of individuals who have commented on the proposed rule. The Small Business Administration considers small entities to be businesses, non-governmental organizations, or small governmental jurisdictions—not individuals. The estimated number of entities affected by the rule will be significantly smaller than the number of individuals who commented on the rule or who currently possess PMFs. Under the final rule, PMFs owned by individuals do not have to be serialized unless the PMF is transferred to an FFL and the FFL voluntarily accepts the PMF into inventory. At the time of the NPRM, ATF assumed that individuals who own PMFs would likely choose to avoid going through an FFL when disposing of their firearms to avoid serializing their PMFs. However, for the final rule, ATF outlines the individual populations and costs if individuals choose to take their PMFs to an FFL, and if that PMF is accepted into inventory. In addition, neither the NPRM nor this final rule define “privately made firearm” as including firearms manufactured or made prior to October 22, 1968, and this rule does not affect pre-October 22, 1968, firearms that were not serialized unless remanufactured after that date.

ATF did not account for the costs to entities that specialize in firearms customization for marksmanship competitions because the changes to the final rule’s definition of “frame or receiver” would not change the ability of these “micro-sale businesses” to customize firearms by replacing pistol slides and accessories. Under the final rule, these items would not be considered “frames or receivers.” Therefore, those businesses would not be required to be licensed as manufacturers if they customize firearms by replacing pistol slides and accessories for individual unlicensed customers.

#### d. Definition of “Frame or Receiver”

##### Comments Received

Many commenters stated that having firearms with multiple serial numbers would be cost prohibitive. Some commenters suggested that, should manufacturers have to mark multiple serial numbers, retooling designs would cost a significant amount of money and

investment. They also asserted manufactures would have to spend time and money to match up the firearm pieces into one firearm. Some commenters suggested that this would increase the cost of firearms for purchasers. Other commenters stated that the industry would need to change how it marks, sells, and advertises unfinished receivers that would be considered “firearms” under the final rule.

Commenters stated that the new regulations requiring multiple parts to be serialized would harm both citizens and the firearms industry by limiting growth and innovation in the industry. One commenter stated that the industry would be forced to seek determinations from ATF because manufacturers would be unable to determine which part of the firearm is the frame or receiver. Other commenters stated that firearms manufacturers would be forced to mark multiple parts of a firearm because they might not have requested a determination or received a response to a determination request submitted to ATF. One commenter stated that restricting the parts of a firearm that a company can sell would cause a shift in supply and demand.

One commenter asserted that the cost estimates did not align with how the manufacturing process works. The commenter claimed that, to comply with the rule, manufacturers would have to totally rework their manufacturing processes and recordkeeping systems. Another commenter stated that companies that produce raw forgings and castings would be required to become FFLs. The commenter claimed that this would increase the cost of these items or cause manufacturers to change their production to include machining of the raw materials.

Some commenters suggested that it would cost more to purchase individual pieces because they would now have to go through FFLs to purchase their firearm kits and pay a transfer fee for each frame or receiver they purchase. One commenter asked if there would be enough FFLs to serialize firearms in the required time period, asked how individuals with disabilities or without transportation would visit an FFL to have their firearms serialized, and asked if individuals would be reimbursed for unserialized firearms seized by the government.

##### Department Response

Based on the public comments received, the final rule changes the proposed definition of firearm “frame or receiver” to identify only one part of a

firearm that will need to be marked. However, if a company were to sell a firearm parts kit with a partially complete “frame or receiver,” or a multi-piece frame or receiver where there is more than one modular subpart, the frames or receivers of these items will now need to be serialized in accordance with this rule, increasing the cost of these items.

ATF acknowledges that the proposed regulation would have posed some compliance issues for manufacturers and that some companies that were not FFLs would have needed to become FFLs under the proposed rule. ATF modified the rule to alleviate those concerns by expressly excluding raw materials, by further clarifying certain terms, and by allowing manufacturers to adopt existing marks of identification in several circumstances. Further, retailers were required under the NPRM—and are required under the final rule—to mark only unserialized firearms that they currently have in inventory and any PMFs they take into inventory after the implementation of the final rule. In this regard, licensees will continue to have 60 days until after the effective date of the final rule to serialize firearm parts kits with partially complete “frames or receivers” that they currently have in inventory.

ATF concurs that individuals will now need to visit an FFL to purchase those firearm parts kits with a partially complete “frame or receiver” that may readily be completed, like other firearms. However, because there will only be one frame or receiver per kit, there will be no additional transfer fees.

#### e. Firearm Kits With “Partially Complete Frames or Receivers”

##### Comments Received

ATF received various comments regarding the methodology used for determining populations and costs for non-FFL manufacturers of partially complete frames or receivers and firearm kits. Several commenters treated the manufacturers and retailers of these items as one group and stated that the population estimated by ATF was too low. One commenter claimed that ATF misstated the number (36) of non-FFLs selling firearm parts kits with a partially complete “frame or receiver” because an internet search the commenter conducted on “80 lower” returned more than 75 websites selling these items.

Many commenters asserted that ATF could not properly determine how much of an effect on commerce this rule will have for manufacturers. Some commenters stated that ATF did not account for non-FFL manufacturers

becoming licensed. Other commenters claimed that the new regulations would ruin non-FFL businesses that sell unregulated parts. One commenter opined that non-FFL manufacturers are not likely to become licensed and that, because most of these companies are small, this final rule will force these companies to go out of business. One commenter stated that ATF did not account for lost revenue and increased expenses for gunsmiths, companies producing firearm parts kits, and individuals. Some public commenters stated that non-FFLs would be unable to become licensed either due to the costs associated with becoming licensed or zoning restrictions, and that ATF did not account for companies going out of business.

Commenters stated that ATF did not estimate the impact on revenue this rule will have on the public and that ATF's assumptions were unsupported. One commenter stated that ATF made a flawed assumption that there would be no cost because non-FFL manufacturers would choose not to become licensed because of the "primary marketing scheme of some of these non-FFL manufacturers." The commenter claimed that, even if only a few of these manufacturers choose to become licensed, the costs could be in the millions. Another commenter similarly stated that there was no analysis or evidence presented on non-FFLs choosing to become licensed or forgoing selling newly regulated items. One commenter stated that ATF failed to estimate the number of parts kits and PMFs and that it did not quantify the total costs for destroying or turning in such items. Additionally, the commenter stated that ATF failed to explain how it arrived at the conclusion that all non-FFL retailers would choose to destroy their inventory of unmarked parts kits and PMFs.

One commenter stated that, according to the RIA, parts kits and some unfinished receivers currently available will no longer be sold. This commenter asked if the RIA assumed that non-licensed manufacturers will produce kits with "unformed blocks of metal." The commenter believed that sales of such kits would be lower than sales of existing kits because it would take more skill and additional tools to transform the new kits into frames or receivers. One commenter stated that ATF failed to provide an analysis of the exact amount of revenue per business that non-FFL retailers would lose if they chose to sell part kits without unfinished receivers. One commenter stated that the assumption in the RIA was that kits without a frame or receiver

would not be regulated, but that the text of the proposed rule did not make this clear.

A couple of commenters stated that ATF's assumptions that 10 percent of Type 01 and Type 02 FFLs currently deal in firearm parts kits with a partially complete "frame or receiver" and that all dealers would have only two such items in inventory lacked any supporting evidence or data and cited only unknown subject matter experts.

Several commenters suggested that the populations, cost assumptions, and descriptions for in-house engraving were inaccurate. One commenter stated that engraving equipment is not common at FFLs. One commenter suggested that the only viable means of engraving is with a laser engraver, associated equipment and safety supplies, and a specialized worker. Several commenters suggested the labor and equipment needed to engrave existing inventory is significantly higher than the stamping method discussed in the NPRM. Another commenter stated that the costs in the ATF's analysis were underestimated and questioned how ATF came to the conclusions about the number of FFLs that have parts kits, who would mark the kits, how they would be marked, and why kits that do not need to be serialized would have an embedded metal plate on which to mark a serial number. The commenter also noted that ATF did not include the cost estimate for the 36 non-FFL dealers to have their parts kits marked by a licensee. One commenter stated that ATF's estimate of a one-time cost for contracting out gunsmithing services in order to mark inventory that would need to be serialized was unsupported by evidence or data.

#### Department Response

ATF partially concurs that the population of affected dealers of firearm parts kits with partially complete frames or receivers was underestimated. In the NPRM, ATF found 71 companies selling such kits. Because the requirements for manufacturers and retailers are different, ATF accounts for them separately in different chapters of the RIA, which makes the numbers per chapter lower than the population estimates suggested by commenters. Although all 71 companies sell firearm parts kits with a partially complete frame or receiver, ATF broke up the number of companies between manufacturers and dealers of kits. After receiving comments, ATF performed a second internet search of companies and found an additional 58 companies, but broke up the total number of companies into four groups: FFL and

non-FFL manufacturers, and FFL and non-FFL dealers. By categorizing the companies this way, the population numbers appear to be relatively low in each chapter of the RIA, but the overall number of companies affected is similar to the estimated total number of companies suggested by the commenter.

For the final RIA, ATF revised the methodology and costs associated with this final rule to incorporate the costs that commenters suggested will arise. ATF concurs that lost revenue was not accounted for in the proposed rule, and the final rule now incorporates both the loss in revenue for companies and additional expenses for individuals. Under the final rule, firearm parts kits with partially complete frames or receivers will no longer be able to be sold without a serial number. The RIA revised the estimates to assume that firearm parts kits with partially complete frames or receivers will be regulated. As a result, ATF revised its estimates to reflect companies that could dissolve their businesses and provided a more precise estimate as to how much revenue non-FFL retailers would lose due to the requirements of the final rule.

In response to commenters that stated ATF's assumptions were lacking a detailed methodology or were otherwise unsupported, ATF reiterates that the agency does not maintain consolidated or aggregated records on companies' inventory, regardless of whether the item in question is regulated, nor can ATF interview all manufacturers to determine their intended future actions upon publication of the final rule. Moreover, most of the items in companies' inventories are not currently regulated. ATF has made reasonable estimates based on information provided by commenters, willing participants in informational surveys, and ATF subject matter experts. In the NPRM, ATF relied on subject matter experts from the Firearms Industry Programs Branch to provide an estimated population, *i.e.*, the number of firearm parts kits with a partially complete frame or receiver in inventory. However, because such parts kits are not viewed by industry members as regulated, and because ATF does not have the inventory data that FFLs maintain, ATF is unable to obtain estimates at the level of accuracy requested by public commenters. However, to improve on these estimates for the final rule, ATF relied on general observations from its field divisions to estimate population and inventory. This was determined to be the best information available for the analysis.

Next, ATF concurs with commenters that the costs associated with the in-house engraving methods outlined in the NPRM were inaccurate, and ATF has changed its assumptions that considered only FFLs that currently have gunsmiths on staff. ATF estimates a one-time contracting cost for gunsmithing services to account for FFLs that have firearm parts kits with a partially complete frame or receiver currently in inventory but do not have gunsmithing capabilities. ATF made this assumption because, based on anecdotal commentary from various ATF field division offices, as well as comments on the NPRM, most FFLs do not have gunsmiths on staff; therefore, it is unlikely that they will purchase engraving equipment if the staff and equipment are not already part of their normal operations. It is not clear that only FFLs with gunsmithing capabilities will carry firearm parts kits with a partially complete frame or receiver; therefore, ATF assumed that a portion of the population will need to contract for gunsmithing services.

As for purchasing a laser engraver, associated equipment and safety supplies, and labor, ATF used information about such costs to illustrate engraving expenses for manufacturers. ATF disagrees that a licensed dealer will need to purchase such equipment or hire more employees with the requisite engraving skills because future firearm parts kits with a partially complete frame or receiver will be serialized by a licensed manufacturer and not the licensed dealer. ATF concurs that it did not account for costs from serializing such parts kits made from polymer materials. In order to account for these costs, ATF has now included the costs for disposing of such items if they cannot be serialized. ATF also concurs that the cost for non-FFL dealers to serialize was omitted from the analysis and therefore has incorporated such costs into its revised RIA.

#### f. Gunsmithing

##### Comments Received

ATF received numerous comments on gunsmiths. Commenters, including a licensed manufacturer that operates as a small business, stated the rule will have a major impact on the business by increasing the cost of gunsmithing services and recordkeeping requirements. The licensee claimed that the resulting decrease in profitability will affect the company's ability to expand and asserted that the new regulations would complicate the process of performing a quick activity, such as bore sighting or adjustments,

because the firearm must be recorded in the A&D records and the firearm must be marked with a serial number. This licensee also stated that many gunsmiths perform services that do not involve engraving and that these FFLs would need to expand their services or lose business.

One commenter stated that persons should not have to be licensed to provide marking on firearms for nonlicensees because it is the responsibility of the FFL to ensure the firearm has been marked per regulation. The commenter also argued that licensing would increase costs without adding any benefits. Additionally, this commenter believed that ATF used the incorrect occupational code for salary and wages in the RIA and that the more precise code has a higher labor rate. One commenter described the significant burden and expense a gunsmith in training would endure to acquire the parts necessary to build 30 different firearms. The commenter explained that parts purchased online would need to be transferred through an FFL, which involves fees for completion of the Form 4473, and a second trip to the FFL after the required 10-day waiting period in his location.

One commenter asked for an explanation regarding the "one-time cost for contract gunsmithing estimated to be \$180,849" and the \$45,212 listed in chapter 4.3 of the RIA. This commenter asserted that ATF underestimated the number of A&D Record entries that gunsmiths would need to make and the cost of making these entries. The commenter argued that the hourly wage used for the calculation is out of date because the cost of labor has increased. One commenter suggested there was a discrepancy regarding contract gunsmithing. Another commenter worried that ATF significantly underestimated the activities for gunsmithing and did not understand why the number of items needing to be serialized was so low. One commenter did not agree with ATF's assessment in chapter 4 of the RIA that "3,359 FFLs would outsource their firearms to another FFL for gunsmithing work."

##### Department Response

ATF affirms that the current A&D Record requirements need to be maintained whenever firearms are acquired in inventory. The final rule clarifies that Type 01 and Type 02 FFLs that do gunsmithing work that includes marking services for nonlicensees are not required to apply for a Type 07 manufacturer's license. ATF reiterates that PMFs for personal use are not

required by the GCA or this rule to be serialized (unless required by State or local law); instead, serialization is required only for those that are taken into inventory, which—as the final rule clarifies, based on ATF's longstanding view—does not include same-day adjustments or repairs. Because repairs are performed by gunsmiths, ATF assumes that only FFLs that are gunsmiths or hire gunsmiths will be performing repairs or customizations of PMFs, so ATF incorporated the annual costs for these FFLs.

As stated by various public commenters and reinforced by ATF subject matter experts, not all FFL dealers are capable of engraving; therefore, there may be FFLs that outsource their existing inventory of firearm parts kits with a partially complete frame or receiver to another FFL or a non-FFL that has engraving services available under the FFL's direct supervision. Existing PMFs currently in inventory are not required to be marked under the FFL's direct supervision so long as the marking occurs within 60 days from the effective date of the rule, or prior to final disposition, whichever is sooner. As for the affected populations, because such parts kits are not currently viewed by their manufacturers or members of the public as regulated, ATF is not able to definitively determine the number of affected items that would need to be serialized with the specificity that commenters requested.

#### g. Silencers

##### Comments Received

One commenter stated that ATF underestimated the cost to serialize all parts of a silencer while another commenter stated that the benefits of adding additional serialized parts of a silencer do not outweigh the costs. One commenter asked if ATF would pay for replacement of parts. One commenter believed that multiple parts of a silencer would be classified as the frame or receiver; the commenter also claimed that every silencer manufacture would need to request a variance and that ATF did not include the cost of processing the variances. One commenter asked if ATF would be covering the cost of a silencer part if it is damaged while the serial number is being marked. Additionally, the commenter wanted to know who would pay to have the silencer parts marked if all parts need to be marked.

##### Department Response

In both the proposed and final rule, ATF required or requires only that the

“frame” or “receiver” of a firearm muffler or silencer device be marked, and the final rule makes clear which part is the frame or receiver of a modular silencer. Additionally, the final rule makes clear that the end cap of a silencer or a sound suppressor cannot be a “frame” or “receiver.” Based on public comments received in the ANPRM for silencers and mufflers, *see* 81 FR at 26764, the final rule will not significantly change the way the industry currently marks silencers. In most cases, the “frame” or “receiver” would be the outer tube.

Under Federal law, 26 U.S.C. 5842(a), and 27 CFR 479.102, each person manufacturing or making each “firearm”—including a “muffler or silencer,” *see* 26 U.S.C. 5845(a)—is required to mark the “firearm” in accordance with the regulations and register it in the NFRTR. This rule as proposed and finalized eliminates the substantial cost of marking each and every individual internal part defined as a muffler or silencer, as well as the end cap of an outer tube. Additionally, under this rule, individual internal muffler or silencer parts may be transferred by NFA-qualified manufacturers to other qualified licensees for further manufacture or repair of complete devices without immediate registration or payment of NFA transfer tax, and complete devices that are registered may be temporarily conveyed for replacement of these internal parts. However, the term “repair” does not include replacement of the outer tube. The outer tube is the largest single part of the silencer, the main structural component of the silencer, and the part to which all other component parts are attached. ATF has, therefore, taken the position that the replacement of the outer tube is so significant an event that it amounts to the “making” of a new silencer. Hence, the new silencer must be marked, registered, and transferred after payment of transfer tax in accordance with the NFA and GCA.<sup>140</sup> By law, this transfer

<sup>140</sup> Under this rule, the frame or receiver of a muffler or silencer is the part that provides housing or a structure for the primary internal component designed to reduce the sound of a projectile. Typically, this is the largest external part, or outer tube, without which the device would have no structure to hold the primary internal sound reduction component(s) and that is marked with a serial number, registered in the NFRTR, and for which excise tax must be paid. ATF has long taken the position that the creation of the outer tube results in the making of a new silencer, *see* 26 U.S.C. 5845(i) (definition of “make”), and the fact that a tube is used to replace a damaged outer tube is of no consequence because a functional device cannot be made without it. For this reason, the new regulatory text expressly excludes muffler or silencer frames or receivers from being transferred

tax is owed by the transferor, not the government. *See* 26 U.S.C. 5811(b).

#### h. Markings on “Privately Made Firearms”

##### Comments Received

One commenter worried that requiring firearms made from parts kits to be marked would destroy their value as collector’s items. One commenter stated that the loss of tax revenue due to acquisition of marking equipment was not calculated in the costs described in ATF’s RIA. Many commenters feared that FFLs would lose business because they do not have engraving machines and cannot work on PMFs. Several commenters stated that the cost of serializing a PMF ranges between \$35 and \$405 based on whether the services include serializing alone or related services such as cleaning, oiling, bluing, polishing, or refinishing the firearm. One commenter stated that the per-individual costs in the RIA were underestimated because individuals tend to own more than one firearm and that the per individual cost should include several handguns and at least one rifle. Another commenter claimed that the assumption that individuals will not be charged for serialization is inaccurate.

One commenter stated that the type of “low cost, hand-embossing tools” used for estimates of marking costs were not appropriate for marking steel or aluminum frames or receivers because the depth requirement may not be met, making the markings less durable. Many commenters asserted that a laser engraving machine would be needed to meet the marking requirements. One commenter stated that these machines cost at least \$10,000 and that this type of machine is not available at most firearms retail stores. Many commenters were concerned that the estimated engraving cost of \$25 is too low and suggested that the actual cost of engraving is between \$45 and \$65. One commenter was also skeptical of the low number of PMFs that ATF stated were in dealers’ inventories because the agency provided no evidence as to how this number was determined.

One commenter stated that the rule would “reduce consumer value” by reducing the number of available parts kits because it would hurt hobbyists who enjoy building their own firearms and take away the privacy of owning an unmarked firearm. One commenter stated that not all FFLs have the equipment to mark firearms and that

for replacement purposes without marking, recording, and registering them in accordance with 27 CFR parts 478 and 479.

Type 07 manufacturers that do have the equipment may not want to mark PMFs. This commenter did not believe there are enough FFLs with the proper equipment for the number of firearms that will need to be marked. One commenter stated that chapter 6 of the RIA did not address the costs associated with recordkeeping for PMFs.

##### Department Response

ATF disagrees that it needed to calculate the loss of tax revenue due to acquiring serializing equipment. Estimating tax revenue is beyond the scope of the rule and is speculative, especially since companies are not required to purchase equipment, much less become FFLs. ATF also disagrees that it did not properly estimate the total number of PMFs affected by the rule or that it underestimated the number of firearms affected per individual. Neither the proposed nor final rule requires the serialization of all PMFs in circulation. This aspect of the rule affects only firearm parts kits with a partially complete frame or receiver held by FFLs and PMFs that are transferred through an FFL; therefore, ATF account for only kits and PMFs held by FFLs or that may go through FFLs. However, in the final analysis, ATF provides an estimate of the total number of PMFs in circulation, along with potential costs to individuals who go through an FFL for services associated with marking their PMFs.

FFLs are not required to acquire equipment to serialize firearms. Should they choose to receive a PMF from a non-FFL, the FFL could either require the individual to serialize the PMF prior to acceptance or directly oversee the engraving by another FFL or even a non-FFL. PMFs that may have been accepted into inventory prior to the effective date of this rule may also be outsourced for marking to a licensed manufacturer or gunsmith within the 60-day grace period. ATF revised the estimated costs to assume those with existing gunsmithing capabilities will perform engraving services in-house. FFLs without marking capabilities will either dispose of their inventory, outsource the inventory to another FFL that has marking capabilities, or directly oversee the engraving by a non-FFL. Furthermore, in the NPRM, ATF assumed that individuals with PMFs would not choose to undertake repairs or customization of their PMFs so as to avoid marking requirements; therefore, it did not anticipate those costs to individuals. Based on gunsmithing experience from subject matter experts from the Firearms Ammunition Technology Division, most individuals

seeking repairs or customization typically do not seek bluing or other services at the same time they are seeking engraving services. ATF concurs that the analysis in the NPRM regarding engraving was inaccurate. ATF agrees that a more likely scenario is that there may be some FFLs that sell firearm parts kits with a partially complete frame or receiver that also offer gunsmithing services. These FFLs will not need to purchase embossing equipment; rather, they can use their existing staff and equipment to serialize their existing inventory of kits. For FFLs that do not employ gunsmiths or have existing gunsmithing equipment, ATF estimates that these FFLs will contract out engraving services to another FFL, supervise the engraving services from a non-FFL, or dispose of their inventory. In order to simplify costs, ATF estimated only serialization from FFLs and not non-FFLs being supervised by the contracting FFL.

ATF concurs with commenters that there would be an additional cost for hobbyists and has updated the economic analysis accordingly. ATF revisited its estimate of the cost to have multiple serial numbers on a firearm because, under the final rule, the definitions identify only one frame or receiver per firearm and therefore the vast majority of firearms will only have one serial number per firearm. Because only one regulated part will be defined as a “frame or receiver,” ATF anticipates the cost would not be prohibitive for hobbyists.

Although FFLs are regulated, ATF does not have any records or data reflecting the number of weapon or frame or receiver kits with a partially complete frame or receiver that FFLs may have in their inventories. Furthermore, the Paperwork Reduction Act prevents ATF from surveying more than nine companies for information without going through the formal procedures to collect information from the public. *See* 44 U.S.C. 3502(3)(A)(i). As stated above, ATF revised the methodology to ascertain the number of FFLs affected and the number of firearm parts kit with a partially complete frame or receiver by relying on information from ATF’s field divisions to estimate this population, which was determined to be the best available information available for the analysis.

#### i. Records Retention

##### 1. Population

##### Comments Received

ATF received various comments regarding the population affected by the cost of record retention. Some

commenters stated that the cost of shipping all firearm records to ATF was not accounted for or that ATF’s estimated shipping cost was too low to account for shipments from all FFLs. Another commenter suggested that, regardless of whether an FFL ships records to ATF voluntarily, all FFLs should be accounted for, not only the ones that currently destroy their records that are over 20 years old. One commenter stated that ATF should have done an advanced notice of proposed rulemaking to find out the number of FFLs that retain their records for more than 20 years instead of relying on subject matter expert estimates. The commenter also believed that ATF’s estimate that less than 10 percent (or 5,407) of dealers and collectors are not retaining their records beyond 20 years is too low because the RIA lists the number of FFLs at 113,204, and 10 percent of this number is 11,320, which is twice what is listed in the RIA.

##### Department Response

The Department disagrees with commenters who said the agency underestimated the cost per FFL and that it should have taken into account the costs borne by all FFLs. Federal law, *see* 18 U.S.C. 923(g)(4); 27 CFR 478.127, already requires FFLs to send all of their out-of-business records to ATF. ATF does not consider these costs as attributable to the rule because the duty to send out-of-business records to ATF is an existing statutory and regulatory requirement. In the NPRM, ATF estimated that most FFLs currently store records beyond 20 years and will not be affected by the indefinite records retention requirement. As described below, the cost burden for extending the record retention requirement will affect only a subset of the total number of FFLs. Furthermore, the Office of Management and Budget (“OMB”) explains that the baseline for measuring a rule’s costs should be “what the world will be like if the proposed rule is not adopted.”<sup>141</sup> Prior to the publication of the NPRM, the majority of FFLs maintained records until discontinuance of business or licensed activity regardless of whether they remained in business for 20 years or not. Because any alternative, including the proposed rule, would be a comparison against this baseline, only the incremental cost above this baseline is attributed to this rule.

<sup>141</sup>OMB, *Circular A-4* at 2 (Sept. 17, 2003), available at [https://www.whitehouse.gov/wp-content/uploads/legacy\\_drupal\\_files/omb/circulars/A4/a-4.pdf](https://www.whitehouse.gov/wp-content/uploads/legacy_drupal_files/omb/circulars/A4/a-4.pdf) (last visited Mar. 23, 2022).

The 113,204 total number of FFLs is for all types of FFLs at the time of the analysis. Records retention affects a subset of all FFLs, in particular, Type 01 and Type 02 FFLs, because licensed manufacturers (Types 06, 07, and 10) and importers (Types 08 and 11) generally maintain permanent consolidated production, acquisition, and disposition records in accordance with 27 CFR 478.129(d) and ATF Rulings 2011–1 and 2016–3. Additionally, ATF estimates that licensed collectors (Type 03) generally maintain their curio or relic collection records until discontinuance of licensed activity. At the time of the NPRM, there were only 60,079 Type 01 and 02 FFLs, and of those, fewer than 10 percent were estimated to be destroying their records that were more than 20 years old. In the RIA for the final rule, ATF reiterates that records retention primarily affects Types 01 and 02 FFLs, and thus not all FFLs are listed in the overview of the analysis.

#### 2. Costs

##### Comments Received

Various commenters suggested that the new reporting requirements alone should have made the rule economically significant. Commenters suggested that ATF did not account for the influx of transactions records for multiple “frames” or “receivers” or the influx of transaction records from purchases of firearm parts kit with a partially complete “frame or receiver” that would be disposed of as a “firearm” under the rule. Similarly, one commenter suggested ATF should use NICS checks and population growth models to account for the increased number of transactions and number of records in the future.

One commenter suggested that, in 2018, nine million firearms were manufactured. Accounting only for nine million firearms, the cost burden per record was estimated to be \$0.02 per record. One commenter argued that the NPRM’s cost estimate of \$68,939 does not realistically encompass the recordkeeping requirements for all 79,869 FFLs because the number of records retained and therefore submitted will grow over time. This commenter further suggested that, based on the NPRM estimate of \$68,939 for the entire industry, the per shipment cost for all records over 20 years would be \$0.86 per FFL, which the commenter asserted was too low. Other commenters stated that the RIA estimated only additional storage costs for ATF but not the costs to FFLs.

Several commenters suggested that the NPRM did not account for the increase in the number of records FFLs will have to maintain due to the increased number of transactions likely to happen if a firearm has multiple serial numbers. One estimated that the recordkeeping burden for ATF Forms 4473 would increase by 437 million.

One commenter stated FFLs that have voluntarily retained records beyond 20 years will have a greater cost of storing records indefinitely than FFLs that destroyed or surrendered records older than 20 years because the FFLs that retained their records will overall have more records that will need to be stored. This commenter believed that the rule change will encourage FFLs to destroy records beyond 20 years prior to the change, which will hurt ATF's ability to trace firearms.

One commenter estimated that it would cost the firearms industry \$8.1 billion to develop and secure electronic records and that it would cost ATF \$546 million annually to maintain and support electronic storage of records. Several commenters suggested that the low records retention cost described in the RIA was due to an over-reliance on savings from converting paper records to electronic storage. One commenter suggested that the cost for electronic storage should include a team of employees to create and maintain electronic storage for the FFL.

One commenter suggested that ATF relied too heavily on subject matter experts for assumptions used in the RIA and noted that the experts' methodologies were unknown to the public. Furthermore, this commenter questioned the assumption that all FFLs would send their records older than 20 years to ATF. One commenter suggested that ATF consider an alternative to this requirement with a time frame between 20 years and indefinite.

#### Department Response

The Department did not account for the potential increase in the number of records stored due to an increase in transactions recorded for multiple "frames" or "receivers;" however, this cost no longer needs to be accounted for as a result of changes to the definition of firearm frame or receiver. Nonetheless, the Department concurs that there will be an increase in firearms records because there could be more firearms transactions; this could increase the overall record retention cost. There were 14 million NICS checks in 2010 and almost 40 million NICS checks in 2021. In the cost section of chapter 7 of the RIA, ATF forecasts the estimated increase in Form 4473

applications based on the number of reported NICS checks and NFA applications by year and estimates the increase in shipping costs for FFLs to send their records to ATF when their business or licensed activity is discontinued.

Under the initial RIA, the \$68,939 cost to retain records beyond the existing 20-year requirement was not distributed among the total 113,204 FFLs. ATF subject matter experts report that most FFLs already retain records indefinitely beyond the existing 20-year requirement until discontinuance of business or licensed activity. For most FFLs, this practice is already an industry standard and thus the cost of this practice is not attributable to this rule. Therefore, as stated in the NPRM and the final rule, not all FFLs will incur recordkeeping costs as a result of this rule's implementation. However, ATF agrees that there may be some FFLs that do not maintain records indefinitely or that transfer their records to a successor FFL. These FFLs may now incur additional recordkeeping costs to comply with this rule. Costs were estimated for these FFLs and ATF has revised the final analysis.

Because FFLs are required by 18 U.S.C. 923(g)(4) and 27 CFR 478.127 to send all of their records to ATF upon absolute discontinuance of their business or licensed activity, ATF does not consider costs for FFLs to ship their records to ATF upon such a discontinuance to be a cost of this rule; instead, it is a cost of the existing requirement in 18 U.S.C. 923(g)(4) and 27 CFR 478.127. ATF did not receive comments that would otherwise contradict the recordkeeping analysis; therefore, the NPRM cost analysis remains the same.

Most FFLs have and will continue to retain records, and this rule will not affect these FFLs. As stated above, most FFLs retain records for more than 20 years. This existing activity pre-dates the final rule, and costs of this activity thus are not attributable to the rule. However, the small number of FFLs that currently destroy records older than 20 years could incur some costs. For purposes of the final RIA, ATF estimates that, in an effort to reduce their costs, these FFLs may utilize electronic storage. Furthermore, most FFLs that use electronic formats of A&D records or electronic Forms 4473 outsource these software applications to a third party rather than hiring staff and building the program in-house; therefore, ATF is not incorporating the cost for an FFL to create and maintain electronic storage of their records.

ATF uses subject matter experts as the best available information when it lacks data because there is no requirement to regulate or track certain activities or items. However, ATF was able to use trace data and out-of-business records as a proxy to estimate the number of FFLs that do not retain records older than 20 years and that therefore could be affected by this rule. For this final rule, ATF determined this to be the best available information. Also, in its final analysis, ATF revised the costs for FFLs that currently voluntarily ship records older than 20 years. Upon promulgation of this rule, these FFLs will no longer be able to ship their records to ATF that are older than 20 years without discontinuing business or licensed activity. However, shipping out-of-business records remains an option should these FFLs choose to discontinue their current licensed business or activity and apply for a new license for a business that maintains an electronic recordkeeping system so that they may dispose of their paper records to ATF.

#### 3. Benefits

##### Comments Received

Some commenters stated that ATF did not quantify or monetize benefits for the record retention requirement. One commenter suggested that the benefits do not outweigh the costs. One commenter asserted that ATF did not demonstrate how many crimes would be solved through tracing firearms over 20 years old. Some commenters believed that, with records older than 20 years, ATF would be unable to identify the most recent owner of the firearm because too much time would have passed, and this would lead to increased failures in tracing. One commenter believed ATF failed to meet the requirements of the APA because it did not explain how electronic records would lower the cost of storing records, nor did ATF explain why it did not include this information.

##### Department Response

Tracing a firearm that was involved in a criminal activity is an existing requirement and not a new requirement attributable to this rule. Based on the amount of records previously received by the NTC, ATF anticipates the cost burden for this requirement will be small. Commenters are incorrect in their assumption that the rule would lead to an increased rate of failed traces because the records are too old. To the contrary, being able to trace a firearm to the first unlicensed transferee of the firearm from a firearms licensee, no matter how



long ago, provides useful investigative leads to law enforcement. Furthermore, this final rule now includes, in Section IV.B.5.d of this preamble, information on the number of traces submitted over the past 12 years that could not be successfully completed because the licensee informed ATF it did not have the record for that firearm because the record was more than 20 years old and had been destroyed.

ATF disagrees with respect to putting forth additional analysis regarding electronic storage. The option for electronic storage is an existing option and this rule only expressly codifies and expands that option for licensees in an alternate method approved by the Director. *See* ATF Rul. 2016–1; ATF Rul. 2016–2. Specifically, it is anticipated that the option for maintaining electronic storage of ATF Forms 4473 will be updated via an ATF Ruling issued contemporaneously with this final rule.

#### j. Form Updates

##### Comments Received

Commenters asserted that the cost to update software for electronic recordkeeping was understated. Some commenters feared that it would cost a significant amount of money to update existing software to track multiple serial numbers because current systems allow for only a single serial number. Other commenters stated that some FFLs would need to acquire new software systems because the existing systems may no longer be supported by the original developer to make updates. Some commenters suggested that ATF did not account for extra time needed to enter multiple serial numbers into records.

##### Department Response

ATF concurs that, based on public comments, it would likely cost a significant amount of money to revamp software programs to account for multiple serial numbers. For this and other reasons, ATF has revised the definition of “frame or receiver” so that it describes a single part of a weapon as the frame or receiver, meaning that generally only one serial number would need to be recorded per firearm in the same manner as under current regulations. The rare exceptions would be if a manufacturer or importer chooses not to adopt an existing serial number on a firearm that is remanufactured or imported, or if a multi-piece frame or receiver had been assembled from modular subparts with different serial numbers marked on the same frame or

receiver. Therefore, no cost was attributed to this requirement.

#### k. Government Costs

##### Comments Received

Many commenters stated that the government would incur additional costs associated with lawsuits filed against the rule. Some commenters worried that States will lose sales and tax revenue because companies will go out of business. Other commenters expressed concern that the government would spend more money arresting and incarcerating law-abiding people who they believed would become criminals under this rule. One commenter stated that the rule would lead to increased cost to the government because the government would need additional personnel, equipment, and training to enforce the rule.

##### Department Response

The Department did not account for the cost of lawsuits because costs due to potential lawsuits would be speculative. Although ATF estimated there could be a number of businesses that go out of business, there is no guarantee of accuracy in the number of businesses that would go out of business due to implementation of the rule; therefore, ATF deemed it too speculative to estimate a loss in tax revenue. Furthermore, ATF is not spending more money to arrest people who make and possess PMFs as a result of this rule. As stated earlier, nothing in this rule prevents unlicensed law-abiding citizens and hobbyists from making their own firearms by using commercially produced parts or by using 3D printers; or from transferring PMFs to others as long as they are not engaged in a business or activity requiring a license. If such persons wish to engage in the business of manufacturing, importing, or dealing in firearms, they must obtain a license like any other manufacturer, importer, or dealer.

#### l. Lack of Benefits

##### Comments Received

Many commenters claimed that the assertion that PMFs are used in crimes is not supported by the BJS survey on how criminals acquire firearms (referenced earlier in Section IV.B.8 of this preamble), and that the rule’s asserted benefits are not supported by the FBI’s Uniform Crime Statistics. Many commenters stated that firearms are used in a small percentage of crimes. They claimed that the number of firearms recovered at crime scenes is low and not all perpetrators are arrested

and convicted. One commenter stated that the RIA failed to show why the lack of serial numbers is important to criminals and did not consider other methods that the criminal may use (removing a serial number or using a different type of weapon) to circumvent the new requirements. Another commenter asserted that there is no evidence that PMFs are the weapon of choice for criminals.

Many commenters argued that ATF did not show how the proposed rule would reduce crime. Some commenters stated the NPRM did not indicate the number of traces that identified the perpetrator, resulted in an arrest, or substantially affected the prosecution of the criminal. Nor did it provide the percentage of unserialized firearms used in crimes or show how many crimes could be solved if PMFs could be traced. A commenter asserted that, if the data is available, the public should be able to comment on it. Another commenter pointed to studies that suggest that firearms restrictions do not have an impact on gun violence. One commenter argued that the tracing of serialized firearms has failed to reduce deaths caused by these weapons.

Another commenter stated that the majority of firearms traces are for weapon offenses, not violent crimes such as homicides, assaults, or robberies. “Mere weapon offenses,” according to the commenter, “cause no immediate harm,” and “thus the vast majority of traces do not involve the remediation of many violent uses of guns.” The commenter also argued that the “costs of failing to obtain a conviction on a weapon offense [are] minuscule,” especially because “the perpetrator will likely be convicted of some other associated crime.” This commenter also stated that ATF failed to show how an increase in traces would lead to increased arrests and convictions and that ATF did not provide a monetary benefit of this supposed increase. Because only a small number of firearms required to be marked under this rule will ever be traced, according to the commenter, the “external costs” of failed tracing are low and do not support the burden of the rulemaking. Another commenter argued that homicides committed with PMFs would be a very small portion of cases that would be addressed by this rule, while another commenter claimed that it would take 30 years of homicides committed with PMFs to equal one year of homicides committed with serialized firearms.

One commenter stated that, although ATF reported the number of traces that include suspected PMFs and the

number of homicides related to the usage of PMFs, ATF did not attempt to monetize these deaths and injuries. Another commenter stated that ATF failed to show the value or benefits, either individually or on the whole, of regulating firearms kits with a partially complete frame or receiver or unassembled frames and receivers and related parts kits. One commenter stated that ATF failed to explain why it cannot monetize or quantify the purported benefit of consistent marking requirements. The commenter stated that the agency failed to explain who benefits and how large the benefits are, thus not meeting its burden under the APA. The commenter argued that ATF could have provided the benefit of easing marking requirements without additional marking requirements.

One commenter stated that there is no need for regulation because PMF owners can voluntarily mark their firearms. If they choose not to, the commenter said, it is because they do not find a benefit in it and only hurt themselves if the firearm is lost or stolen. The commenter also stated that ATF failed to provide information on the number of lost or stolen PMFs or parts kits and the number of these firearms or kits that could not be returned to the legal owner due to the lack of a serial number. Additionally, the commenter said ATF failed to show how often criminals receive PMFs using a straw purchaser. Another commenter argued that the rule will not deter straw purchasers.

#### Department Response

The Uniform Crime Statistics referenced by commenters are compiled through the FBI's Uniform Crime Reporting ("UCR") Program. The UCR Program, however, does not collect crime information on PMFs. As a result, ATF did not rely upon UCR Program data to explain the rise in suspected PMFs that are recovered and traced from crime scenes. FBI Uniform Crime Statistics were not considered pertinent for present purposes and were not used in analyzing the costs and benefits of this rule.

Furthermore, based on tracing and National Integrated Ballistics Information Network data, many law enforcement agencies may not be reporting PMFs accurately, and therefore, ATF believes that the number of PMFs reported as being used in crimes is significantly smaller than the actual number. Aware of these potential reporting errors, the number of PMFs ATF has presented in the RIAs accompanying the NPRM and this final rule is likely to be much lower than the

actual number recovered. ATF did, however, provide more quantifiable benefits in the final RIA based on an increased ability to trace all firearms, and particularly, PMFs. ATF reiterates that the primary benefit of the final rule is promoting public safety and restricting felons and other prohibited persons' access to firearms.

#### m. Proposed Alternatives

##### Comments Received

Thousands of commenters claimed that ATF did not mention any one of the regulatory alternatives proposed by the wider firearms industry that several commenters believe were raised with ATF during an early 2021 meeting reported by the Wall Street Journal. See Zusha Elinson, *Ghost-Gun Concerns Prompt Feds to Meet With Firearms Makers*, Wall St. J. (Mar. 26, 2021), available at <https://www.wsj.com/articles/ghost-gun-concerns-prompt-feds-to-meet-with-firearms-makers-11616756403> (last visited Mar. 23, 2022). Other commenters asserted that ATF failed to adequately consider or explain why it was not considering the regulatory alternatives provided in the NPRM. For example, one industry member stated that, of its four regulatory alternatives, ATF did not explain regulatory alternative number one, which was no change, and regulatory alternative number three, which was to grandfather all existing firearms. For instance, the commenter stated that ATF did not explain for alternative number three why it would be difficult to bring enforcement actions against the continued manufacturing of noncompliant receivers or explain why the burden of doing so would not be justified by the alleged fact that there are "no costs" associated with the third option's implementation.

Numerous commenters opposed to the NPRM stated that ATF should grandfather in all personally owned items to preserve citizens' civil liberties and to avoid criminal entrapment. Some commenters suggested that ATF allow non-FFLs to continue selling unfinished lower receivers while placing the burden on the consumer to register the firearm with an FFL once the consumer completes the process of privately manufacturing a lower receiver. The commenter argued that it is illogical to require manufacturers and retailers of unfinished lower receivers to adhere to a regulatory system that is a "veiled scheme of forced compliance against gun owners." In the commenter's opinion, only when an unfinished lower receiver is finished by the end user can the final owner be identified and the

markings be completed and known (e.g., gauge or caliber).

One commenter suggested that ATF consider non-regulatory alternatives such as corrective taxes and subsidies, aid from non-governmental organizations, tort law, public service advocacy, and private contracting. Another commenter suggested that ATF consider other alternatives, such as requiring that records be retained for longer than 20 years (but less than indefinitely) or allowing anyone to mark weapons.

#### Department Response

The Department disagrees with commenters who stated that ATF did not consider regulatory alternatives proposed by the wider firearms industry during an early 2021 meeting reported by the Wall Street Journal because ATF was not presented with any regulatory alternatives other than keeping the current limited and outdated definitions.

The "no change" alternative has no costs or benefits because it would involve maintaining the status quo. This alternative was considered but not implemented because the GCA requires that all firearms be regulated. Currently, the vast majority of firearms fall outside the scope of the existing regulatory definition of "frame or receiver." Due to recent court rulings, it would be difficult for the Department to continue to successfully prosecute criminal activity relying on the existing regulatory definition of "frame or receiver" because that definition does not capture the vast majority of firearm designs.

With respect to grandfathering all existing firearms, the proposed rule sought to allow manufacturers and importers to mark firearms of the same design and configuration in the same manner as before the effective date of the final rule. The final rule makes clear that almost all firearms ATF previously classified as falling within the definition of "frame or receiver" prior to issuance of the final rule are grandfathered and may continue to be marked in the same manner as before the effective date of the final rule. The only exceptions are certain ATF classifications of partially complete, disassembled, or nonfunctional frames or receivers because, at the time of classification of those articles, ATF may not have been provided with, or did not examine, a full and complete parts kit containing those items along with any associated templates, jigs, molds, equipment, tools, instructions, guides, or marketing materials that were made available by the seller or distributor of the item or kit

to the purchaser or recipient of the item or kit. As explained in this final rule, these items and materials are necessary for ATF and others to make a proper firearm classification under the GCA and NFA (if applicable).

To clarify, existing firearm parts kits with a partially complete frame or receiver, and PMFs owned by or serviced by FFLs that were determined not to be “frames or receivers” as defined prior to this rule, will not be grandfathered in, meaning that FFLs may be required to mark these firearms in accordance with the new regulations if the FFLs wish to maintain them in their inventories. This rule does not require unlicensed PMF owners to do anything to their firearms maintained solely for personal use.

ATF has determined that the “non-regulatory alternative” of imposing a higher tax on firearms that are currently being regulated would only make the cost of regulated firearms more expensive to the public and would not affect the PMFs or firearm parts kits that currently fall outside of the regulatory regime. Subjecting firearms to higher taxes would not ensure that all firearms, whether commercially or privately made, are treated the same under the regulations when they enter interstate commerce. This in turn would not achieve ATF’s objectives of ensuring that felons and prohibited persons are not able to obtain firearms and that firearms can be traced. The objective of this rule is not to make firearms more expensive or more difficult for the public to obtain; rather, the objectives of the rule are to ensure that all firearms, as defined by the GCA, are regulated similarly; to remove the current regulatory definitions of “frame or receiver” and replace them with definitions that capture the vast majority of firearm designs and advancements in firearms technology; to allow law enforcement to trace firearms, including PMFs; and to prevent felons and other prohibited persons from easily acquiring firearms. It is not clear how implementing corrective taxes would prevent criminals from obtaining firearms or help law enforcement officers solve crimes.

It is not clear how the commenter’s suggested alternative scenarios using non-regulatory alternatives (*e.g.*, tort or public advocacy) would be carried out. However, these alternatives are out of ATF’s purview and beyond the scope of this regulation; therefore, these alternatives were not considered.

Although the alternative of requiring record retention for longer than 20 years, but less than indefinitely, was considered, ATF determined that this

alternative was not the best course of action. Because firearms are durable items that can be in circulation for many decades or even beyond 100 years, an alternative specifying a specific time frame for record retention requirements would not align with the shelf life of most firearms. Thus, without the indefinite retention requirement imposed by this rule, ATF would continue to encounter the problem of not being able to successfully trace older firearms that are used in the commission of a crime. As a result, ATF does not believe such alternatives would achieve the intended benefits of this final rule.

#### n. Final Regulatory Flexibility Analysis Comments Received

Many commenters asserted that the rule will have a significant impact on small businesses. Other commenters argued that a robust small business analysis was not performed. Some commenters stated that the rule will have a negative impact on many small businesses, including those owned by veterans and families. They further stated the rule would impact businesses that sell firearms parts as well as those that specialize in firearms customization.

A major distributor of firearms parts pointed out that ATF failed to explain how there can be a significant financial impact on individual businesses but not all the businesses in the same industry. One commenter listed multiple reasons the Initial Regulatory Flexibility Act (“IRFA”) was, in the commenter’s opinion, not done according to law. The reasons included a lack of a statement of objectives and legal basis for the proposed rule; a lack of evidence that the 132,023 affected entities would experience minimal or no cost; a failure to accurately estimate the affected population of non-FFL retailers; a lack of sufficient analysis on the impact on non-FFL retailers; and a failure to provide sufficient analysis of the impact on the unfinished lower receiver market. The commenter stated that there was no analysis addressing the cost of becoming licensed or providing options that would have the same result as regulation. Additionally, the commenter believed the market for unfinished receivers would be quickly diminished. One commenter stated that the IFRA analysis contained errors, such as ATF’s failure to monetize or quantify benefits or explain why it did not do so and ATF’s dismissal or underestimation of costs.

One commenter asserted that the rule has “net negative benefits” so it should

not move forward. The commenter believed that the change in record retention requirements would result in fewer successful firearm traces because of the increased number of documents retained. Several commenters stated that ATF failed to provide the actual number of small businesses that would be affected and the estimated costs that the affected entities would incur.

Some commenters stated that manufacturers of unfinished receivers and firearm parts kits with an unfinished frame or receiver would choose not to obtain an FFL and instead go out of business. This would hurt firearms manufacturers because they purchase these items as part of their production process. Several commenters suggested that this rule will result in significant job losses in manufacturing. One commenter stated that this rule would affect his ability to expand his business and another commenter stated that it had put off business expansion and new hiring because of the rule. Another commenter stated that, because of the anticipated increase in the price of unfinished receivers as a result of the rule, he would no longer be able to provide classes in firearms safety, maintenance, and marksmanship.

One commenter stated that the real cost of the proposed rule is not the lost revenue of the affected companies but the loss in the value of these companies, which hurts the companies’ owners. The commenter also stated that ATF failed to show the anticipated number of jobs lost and the value associated with the loss.

Many commenters asserted that ATF underestimated the cost to the industry. One commenter stated that small businesses would need to acquire engraving equipment and inventory tracking systems. Those businesses that could not afford this expense, according to the commenter, would be forced to destroy inventory. One commenter stated that both large and small entities would need to spend time and money to ensure compliance with the new regulations. One commenter argued that ATF did not consider the true cost to non-manufacturing FFLs for equipment purchases and training, and for the volume of PMFs needing serialization to recoup the return on the investment.

#### Department Response

ATF agrees that different entities will experience a range of costs as outlined by the different chapters of the RIA, and ATF revised the regulatory flexibility analysis to describe the largest impact on small businesses, which is that some businesses will no longer continue

operations. The IRFA has been updated to reflect these costs.

ATF concurs that large and small entities may require time to research and understand regulations. However, this is already an existing cost of regulations in this industry in general and is not a new requirement specific to this rule. Therefore, it is not considered a cost of this rule. In accordance with the Small Business Regulatory Enforcement Fairness Act (“SBREFA”), a small business compliance guide will be published because this final rule will impact a significant number of small businesses.

#### o. APA Requirements

##### Comments Received

One commenter suggested that this rule should be considered both a regulatory and economically significant rule because of its impact on a substantial number of small businesses, as indicated in the RIA. Another commenter believed that the rule violated Executive Order 12866.

##### Department Response

As stated in the NPRM, this rule is a “significant regulatory action” under section 3(f)(4) of Executive Order 12866; however, this rule is not “economically significant,” as that term is defined in the Executive Order. An “economically significant” rule is one estimated to cost \$100 million or more in one given year. This rule is not expected to reach that threshold. As discussed in the Final Regulatory Flexibility Analysis (“FRFA”), ATF agrees that this rule could potentially affect small businesses that only manufacture or deal in firearm kits with a partially complete frame or receiver, but notes that whether a rule has significant impacts on small businesses does not determine if the rule is economically significant under Executive Order 12866. Nevertheless, because this rule has the potential to significantly affect small businesses, ATF has performed an IRFA and a FRFA.

#### p. Congressional Review Act

##### Comments Received

One commenter disagreed with the Department’s claim in the NPRM that this rulemaking is not a “major rule,” which is defined in 5 U.S.C. 804(2), in part, as a rule that “resulted in or is likely to result in . . . an annual effect on the economy of \$100,000,000 or more” or; “significant adverse effects on . . . innovation.”

##### Department Response

ATF disagrees that this is a “major rule” as defined under 5 U.S.C. 804(2). This rule is estimated to cost less than \$100 million in any given year, as outlined in the standalone RIA. Further, the Department disagrees this rule stifles or impacts innovation. To the contrary, the regulations are being updated to accommodate changes in firearms technology and terminology, and the industry may develop new innovations to comply with the updated regulations.

#### q. Unfunded Mandate

One commenter believed that the rule would exceed the one-year allowable threshold of \$177 million (adjusted for inflation since 1995) set by the Unfunded Mandates Reform Act. *See* 2 U.S.C. 658c.

##### Department Response

ATF disagrees that the rule will be a major rule under the Unfunded Mandates Reform Act. The rule is estimated to cost less than \$100 million in any given year, as outlined in the standalone RIA.

#### 14. Other Concerns With the Rule

##### a. Comment Process

##### Comments Received

At least one commenter claimed that there were concerns in online groups and boards that a number of comments meeting the guidelines for being publicly posted were “subsequently deleted,” thus “forcing people to issue new comments for the rule,” or that comments were moderated prior to publishing, raising a free speech concern. The commenter stated that, although these comments might have contained offensive language or have included threats, or may have been similar to other comments indicating spam, those comments should still have been considered as either supporting or opposing the proposed rule. Another commenter stated that the agency’s instructions that commenters self-identify and provide contact information “severely limit the degree and amount of public participation.” They also argued that these instructions chilled speech protected by the First Amendment and discouraged members of the public from commenting. Because of this, the commenter stated that ATF should re-open the comment period.

##### Department Response

ATF received just over 290,000 comments during the 90-day comment period. The vast majority of comments were received through the online

Federal portal ([www.regulations.gov](http://www.regulations.gov)) with the balance coming through mail and fax. The NPRM’s Public Participation section informed the public that there may be a significant delay between the time a person submits a comment through one of the three methods before it becomes visible online due to the volume of comments received on any given day. The Federal Docket Management System (“FDMS”), the portal through which Federal agencies manage their rulemaking dockets, requires the agency to review comments before making them visible to the public on [regulations.gov](http://regulations.gov). With the exception of a limited ability to redact, FDMS does not allow agency users of the system to alter or change the substance of a comment. ATF posted and reviewed comments, even numerous duplicate comments (*i.e.*, comments from the same submitter with the same content) that were generally consistent with the posting guidelines, *i.e.*, comments that did not contain excessive profanity or contain inappropriate or sensitive content. No comments were deleted or removed, unless upon request of a submitter.

The Department disagrees that ATF’s instructions that commenters self-identify “severely limit the degree and amount of public participation,” chill speech, or discourage the public from commenting, as evidenced by the volume of comments received on the NPRM, as well as the content of some comments that expressly declared that they will not comply with any regulation. ATF has historically requested persons to self-identify and include contact information largely in the event that a person makes a comment that the agency would like to follow up on to gain further information or perspective from the commenter. There were recent updates to the online Federal portal that allowed the public to submit comments under an “Anonymous” feature; ATF accepted, posted, and considered these comments. Accordingly, the Department disagrees that ATF should re-open the comment period.

#### b. No Federalism Impact Statement

##### Comments Received

At least one commenter asserted that ATF should have prepared a federalism summary for the NPRM pursuant to Executive Order 13132, entitled “Federalism.” This Executive Order is a directive meant to “guarantee the division of governmental responsibilities between the national government and the States” and “further the policies of the Unfunded

Mandates Reform Act.”<sup>142</sup> Under Section 6 of the Executive Order, agencies are not permitted, to the extent practicable and permitted by law, to issue any regulation that has “federalism implications”<sup>143</sup> if the regulation imposes substantial direct compliance costs on State and local governments and is not required by statute, or if the regulation preempts State laws, unless the agency consults with State and local officials and prepares a federalism impact summary.

The commenter argued that, although the NPRM acknowledged that States have chosen different policymaking paths to regulate or not regulate PMFs or kits, the Department and ATF failed to engage in a federalism analysis of its “constitutional and statutory authority for [its] action” in accordance with section 3(b) of the Executive Order. That section requires such analysis and consultation with State or local officials if the agency’s action limits the policymaking discretion of the States and if “there are significant uncertainties as to whether national action is authorized or appropriate.” The commenter further argued that, pursuant to section 4(a) of the Executive Order, the NPRM failed to acknowledge that the Federal re-definition of “firearm” and mandated marking requirements would preempt State laws, such as State laws on the storage and transportation of firearms and on the marking or registration of PMFs. Finally, the commenter observed that State laws often rely on Federal classifications. For all these reasons, according to the commenter, States might be directly affected by the NPRM.

#### Department Response

The Department disagrees that a federalism impact statement is needed for this rulemaking under Executive Order 13132. This rule, which implements the GCA, does not preempt State laws or impose a substantive compliance cost on States. Under the GCA, 18 U.S.C. 927, State and local jurisdictions may enact their own requirements and restrictions on firearms unless there is a direct and positive conflict such that the two cannot be reconciled or consistently stand together. State and local jurisdictions are therefore free to create their own definitions of terms such as

“firearm” and “frame or receiver” to be applied for purposes of State or local law within their respective jurisdictions. They are free to mandate their own requirements concerning the marking, storage, sale, and transportation of firearms.<sup>144</sup> This rule points out that numerous State and local jurisdictions have, in fact, enacted their own restrictions on unmarked, unserialized, 3D-printed, or undetectable firearms, and firearms with obliterated, removed, or altered serial numbers, and have adopted requirements to report or record the serial number marked on pawned firearms.<sup>145</sup> This rule as proposed and finalized does not purport to impose any costs upon or otherwise limit the authority of State and local governments. To the contrary, the GCA and NFA implementing regulations at 27 CFR 478.58 and 479.52, which are not being amended, expressly state that holders of Federal firearms licenses and NFA taxpayers are not conferred any right or privilege to conduct business or activity contrary to State or other law, and that they are not immune from punishment for conducting a firearm or ammunition business or activity in violation of State or other law.

#### V. Final Rule

##### A. Definition of “Firearm”

The rule finalizes, with minor changes, the amendments proposed in the NPRM to the definition of “firearm” in part 478, which clarify that this term includes a weapon parts kit that is designed to or may readily be completed, assembled, restored, or otherwise converted to expel a projectile by the action of an explosive.

##### B. Definition of “Frame or Receiver”

The final rule accepts the recommendations of numerous commenters and provides a new definition to remove and replace the terms “firearm frame or receiver” and “frame or receiver” in §§ 478.11 and 479.11 (referencing § 478.12). The new definition, set forth in a new § 478.12, separately defines “frame” for handguns, and “receiver” for rifles, shotguns, and other weapons that expel a projectile other than handguns. Rather

than a definition that describes any housing for any fire control component, these definitions now describe only a single housing or structural component for one specific fire control component of a given weapon including “variants thereof,” a term that is also defined. For handguns, or variants thereof, it is the housing or structure for the primary energized component designed to hold back the hammer, striker, bolt, or similar component prior to initiation of the firing sequence (*i.e.*, sear or equivalent), even if pins or other attachments are required to connect such component to the housing or structure. For rifles, shotguns, and projectile weapons other than handguns, or variants thereof, it is the housing or structure for the primary component designed to block or seal the breech prior to initiation of the firing sequence (*i.e.*, bolt, breechblock, or equivalent), even if pins or other attachments are required to connect such component to the housing or structure.

The final rule amends the definitional supplement to “frame or receiver” entitled “firearm muffler or silencer frame or receiver” to define a single component of a complete firearm muffler or silencer device as the frame or receiver, and clarifies how the definition applies to a modular device with more than one housing or structure for the primary internal sound reduction components. Specifically, the terms “frame” and “receiver” mean the housing or structure for the primary internal component designed to reduce the sound of a projectile (*i.e.*, baffles, baffling material, expansion chamber, or equivalent) (formerly, “essential internal components”). Additionally, the terms “frame” and “receiver” now exclude “a removable end cap of an outer tube or modular piece.”

The final rule does not adopt the definitional supplement of “split or modular frame or receiver,” though a definition was added to define the term “multi-piece frame or receiver” and text was added to explain how and when such a frame or receiver must be marked. In this regard, the rebuttable presumption in the definition of “frame or receiver” was amended in the final rule to explain that the marked subpart(s) of a multi-piece frame or receiver must be presumed to be part of the frame or receiver of a weapon or device absent an ATF classification or other reliable evidence to the contrary.

The final rule amends the supplement to the proposed definition of “frame or receiver” entitled “partially complete, disassembled, or inoperable frame or receiver” by: (1) Replacing the term

<sup>142</sup> 64 FR 43225 (Aug. 10, 1999).

<sup>143</sup> “Policies that have federalism implications” are defined as “regulations . . . that have substantial direct effects on States, on the relationship between the national government and the States, or on the distribution of power and responsibilities among the various levels of government.” E.O. 13132, sec. 1(a).

<sup>144</sup> See 18 U.S.C. 922(b)(2) (making it unlawful for a licensee to sell or deliver any firearm to any person in any State where the purchase or possession by such person would violate any State law or published ordinance); 18 U.S.C. 923(d)(1)(F) (requiring license applicants to certify compliance with State and local law).

<sup>145</sup> See footnotes 24, 35, and 121, *supra*; see also 86 FR at 27730 n.62. However, State and local jurisdictions are not entitled to redefine, amend, or exempt persons from the provisions of Federal law.

“inoperable” with the more accurate term “nonfunctional”; (2) clarifying that this supplement also addresses frame or receiver parts kits; (3) explaining what it means for a frame or receiver to function as a frame or receiver;

(4) removing the definition “partially complete,” and, instead, expressly excluding from the definition of “frame or receiver” forgings, castings, printings, extrusions, unmachined bodies, or similar articles that have not yet reached a stage of manufacture where they are clearly identifiable as an unfinished component part of a weapon (e.g., unformed blocks of metal, liquid polymers, and other raw materials); (5) clarifying the items that the Director may consider when classifying a partially complete, disassembled, or nonfunctional frame or receiver; and (6) providing detailed examples of what would and would not be a “frame or receiver” that may readily be completed, assembled, restored, or otherwise “converted” to a functional state.

The final rule makes minor changes to the proposed supplement to the definition of “frame or receiver” entitled “destroyed frame or receiver.” For example, the final rule removes examples of specific ATF approved methods of destruction in the regulatory text in favor of general terminology. Additionally, the final rule clarifies that the term “frame or receiver” includes the specific component of a complete weapon or complete firearm muffler or silencer device, including variants thereof, determined (classified) by the Director to be defined as a firearm “frame or receiver” prior to publication of the final rule, except for determinations concluding that a partially complete, disassembled, or nonfunctional frame or receiver (including a weapon or frame or receiver parts kit) was not, or did not include, a firearm “frame or receiver” as previously defined. This “grandfather” provision also includes nonexclusive examples and diagrams of previously classified weapons.

#### C. Definition of “Readily”

The final rule makes minor changes to the proposed definition of “readily” in Parts 478 and 479 to make clear that it applies to any process, action, or physical state, and that the listed factors are only relevant to firearm classifications.

#### D. Definitions of “Complete Weapon” and “Complete Muffler or Silencer Device”

The final rule makes minor amendments to the proposed definitions

of “complete weapon” and “complete muffler or silencer device” in Parts 478 and 479 by deleting “as designed” as it modified the phrase “necessary to function.” This change was necessary to ensure that firearms are not designed to avoid marking time limits by eliminating a nonessential component in the manufacturing process.

#### E. Definition of “Privately Made Firearm”

The final rule makes minor changes to the proposed definition of “privately made firearm” in part 478 to make it consistent with the changes to the definitions of “frame or receiver” and “importer’s or manufacturer’s serial number,” and for clarity regarding the exclusion for pre-October 22, 1968 manufactured firearms.

#### F. Definition of “Importer’s or Manufacturer’s Serial Number”

The final rule modifies the proposed definition of “Importer’s or manufacturer’s serial number” in part 478. The term means the serial number placed by a licensee on a firearm, including any full or abbreviated license number, any such identification on a privately made firearm, or a serial number issued by the Director. It also specifies that for purposes of 18 U.S.C. 922(k) and § 478.34, the term shall include any associated licensee name, or licensee city or State placed on a firearm. These changes ensure that these markings are considered a part of the “importer’s or manufacturer’s serial number” because a firearm is difficult to trace without this information.

#### G. Definition of “Gunsmith”

This rule finalizes with clarifying changes the proposed definition of “engaged in the business” as it applies to a “gunsmith” in part 478. Most significantly, the final rule makes clear that licensed dealer-gunsmiths are not required to be licensed as manufacturers if they only perform gunsmithing services on existing firearms for their customers, or for another licensee’s customers, because the work is not being performed to create firearms for sale or distribution. These services may include customizing a customer’s complete weapon by changing its appearance through painting, camouflaging, or engraving, applying protective coatings, or by replacing the original barrel, stock, or trigger mechanism with drop-in replacement parts.

Licensed dealer-gunsmiths may also purchase complete weapons, make repairs (e.g., by replacing worn or broken parts), and resell them without

being licensed as manufacturers. Likewise, under the final rule, licensed dealer-gunsmiths may make such repairs for other licensees who plan to resell them without being licensed as a manufacturer. They may also place marks of identification on PMFs they may purchase and sell, or under the direct supervision of another licensee in accordance with this rule. Persons performing these activities are distinguished from persons who engage in the business of completing or assembling parts or parts kits, applying coatings, or otherwise producing new or remanufactured firearms (frames or receivers or complete weapons) for sale or distribution. Such persons must be licensed as manufacturers.

#### H. Marking Requirements for Firearms

The final rule makes a number of amendments to the proposed marking requirements in parts 478 and 479. In addition to minor changes to conform the marking requirements to the new definition of “frame or receiver” that describes a single component, the final rule amends the text to explain how and by when multi-piece frames or receivers are to be identified, and that an identified modular subpart thereof may only be removed and replaced under certain limited conditions. With regard to the size and depth of markings, a minor change was made to clarify that only the serial number and associated license number need be marked in a print size no smaller than 1/16 inch. In the section addressing the meaning of marking terms, the final rule also defines the term “identify” to mean placement of identifying markings, clarifies that the term “legibly” means that the unique identification number within a serial number may include non-numeric characters, and also clarifies that the term “conspicuous” means that the markings must be capable of being easily seen with the naked eye.

As to the time period for manufacturers to identify the firearms they produce, the term “from completion of the active manufacturing process” was not adopted in favor of the clearer statement “the entire manufacturing process has ended.” The exclusion from the time period for firearms “actively awaiting materials” was replaced with a rebuttable presumption that firearms awaiting materials, parts, or equipment repair to be completed are presumed, absent reliable evidence to the contrary, to be in the manufacturing process. Also, the time limits to mark firearms differentiate in the final rule between non-NFA complete weapons and frames

or receivers disposed of separately, which must be marked within seven days after completion of the manufacturing process, and NFA firearms and parts defined as firearms, which must be marked by close of the next business day. This provides a reasonable grace period in which to mark firearms manufactured and makes them consistent with their respective recordkeeping requirements under the GCA and NFA. The final rule does not adopt the proposed seven-day alternative for manufacturers to record acquisitions of non-NFA firearms if commercial records are maintained, as it was not necessary in light of the seven-day grace period to mark non-NFA weapons. NFA weapons and parts must be marked and recorded by close of the next business day after manufacture. Furthermore, the final rule does not adopt the provision allowing licensees to obtain a variance for the period of time in which to mark their firearms because the grace periods being codified in the final rule are reasonable and well known to the industry.

The final rule makes minor conforming amendments to the proposed requirement to mark PMFs. Additionally, unlike the proposed rule, the final rule allows licensed or unlicensed engravers to mark firearms on licensees' behalf (with the requesting licensee's information) provided: (1) The identification takes place under the direct supervision of the requesting licensee without the engraver taking the firearm into inventory; and (2) the markings otherwise meet the identification requirements. Also, the final rule text incorporates guidance from the NPRM's preamble that an acceptable method of identifying a PMF is by placing the serial number on a metal serial number plate permanently embedded into a polymer frame or receiver, or other method approved by the Director.

With regard to the marking exceptions, the final rule expands the rules allowing licensees to adopt (and not mark) the serial number or other identifying markings under certain conditions. Specifically, in light of comments received, the final rule allows licensed manufacturers to adopt (and not mark) the serial number and other markings previously placed on a firearm that has not been sold, shipped, or otherwise disposed of to a person other than a licensee (*i.e.*, newly manufactured firearms). This change would supersede ATF Ruling 2009–5, which requires ATF to be notified when marks are adopted as an alternative to marking. The final rule also provides more specificity than the proposed rule

on how licensees who remanufacture or import firearms may adopt (and not mark) the markings on firearms that were sold, shipped, or disposed of to a nonlicensee. The final rule allows licensed manufacturers to adopt the serial number and other identifying markings previously placed on a firearm by another licensee provided the manufacturer is performing services as a gunsmith (as defined in § 478.11) on existing firearms that are not for sale or distribution by a licensee. Further, the final rule allows licensees to adopt the unique identification number placed on a PMF by its unlicensed maker so long as the number is not duplicated on another firearm of the licensee, the number otherwise meets the identification requirements, and the licensee adds their abbreviated FFL number as a prefix to the existing identification number so that the firearm can be traced to the licensee who identified the firearm.

The final rule also differs from the proposed rule in that it does not require firearm muffler or silencer parts that are transferred for further manufacture or repair to be “actively” in the manufacturing or repair process if those parts are being transferred for those purposes. In this regard, the definition of “transfer” in part 479 has been finalized as proposed to exclude temporary conveyances solely for repair, identification, evaluation, research, testing, or calibration.

The final rule retains the marking grandfathering provision, but revises the text to remove “and configuration” and defines “new design” to explain when a frame or receiver is eligible for this exception. Notably, the more limited final definition of “new design” only applies to changes in the design of the existing frame or receiver to the extent it has been functionally modified or altered, as distinguished from performing a cosmetic process that adds to or changes the decoration of the frame or receiver (*e.g.*, painting or engraving), or by adding or replacing stocks, barrels, or accessories to the frame or receiver.

With respect to the voluntary process for seeking an ATF classification of firearms, the final rule clarifies that a firearm sample submitted to ATF must include all accessories and attachments relevant to such classification, and that each request for classification of a partially complete, disassembled, or nonfunctional item or kit must contain any associated templates, jigs, molds, equipment, or tools that are made available by the seller or distributor of the item or kit to the purchaser or recipient of the item or kit, and any

instructions, guides, or marketing materials if they will be made available by the seller or distributor with the item or kit. Further, submissions of armor piercing ammunition with a projectile or projectile core constructed entirely from one or a combination of tungsten steel alloys, steel, iron, brass, bronze, beryllium copper, or depleted uranium must include a list of known handguns in which the ammunition may be used. These changes will help to ensure that ATF can make a proper classification of firearms and armor piercing ammunition. The final rule also clarifies that ATF classifications of a specific component as a frame or receiver, as distinguished from other firearms determinations, may be considered applicable to or authoritative with respect to other firearms produced by the requestor that are similar so that a separate classification does not need to be submitted to know which portion of a similar weapon to mark.<sup>146</sup>

#### *I. Recordkeeping*

Because firearms would not have more than one frame or receiver, the final rule does not finalize the proposed changes to Parts 447, 478, and 479 to refer to in the plural form the manufacturer or importer name, country of manufacture, or serial number in required records. However, in the unlikely event there is more than one manufacturer or importer, country of manufacture, or serial number marked on a firearm, licensees must still record more than one name, country, or serial number in accordance with the existing regulatory requirements.<sup>147</sup> In addition, the final rule substitutes “transaction number” for “serial number” in part 478 with respect to the manner in which ATF Forms 4473 must be maintained to avoid confusion with the “importer's or manufacturer's serial number” placed

<sup>146</sup> ATF Rulings are different from private letter firearms classifications. ATF issues formal public rulings (as distinguished from “private letter firearm classifications” to individual industry members) to promote uniform understanding and application of the laws and regulations it administers. ATF Rulings apply the law and regulations to a specific set of facts, and apply retroactively unless otherwise indicated, whereas private letter firearm classifications are in response to a private inquiry for a determination regarding a specific item or parts kit by ATF. Rulings do not have the force and effect of ATF regulations, but may be cited and relied upon as precedents in the disposition of similar cases. *See* 27 CFR 70.701(d) (as in effect on January 23, 2003, and continued by 28 CFR 0.133(a)(2), (3)).

<sup>147</sup> *See* 27 CFR 478.11 and 479.11 (“Words in the plural form shall include the singular, and vice versa . . . .”); FFL Newsletter, May 2012, at 5 (“If a firearm is marked with two manufacturer's names, or multiple manufacturer and importer names, FFLs should record each manufacturers' and importers' [sic] name in the A&D record.”).

on a firearm. Further, the proposed recordkeeping requirement in part 478 to record a “serial number” is amended to clarify that any license number either as a prefix, or if remanufactured or imported, separated by a semicolon, must be recorded in the serial number column for accurate tracing. The final rule also amends the proposed recordkeeping requirement for manufacturers in part 478 to make clear that production and acquisition records for non-NFA firearms manufactured or otherwise acquired must be recorded within seven days, not by close of the next business day as stated in the proposed rule, though NFA firearms must be recorded by close of the next business day unless there is a sufficient commercial record of acquisition, in which case the grace period to record would be extended until the seventh day.

With regard to the licensee’s acquisition of PMFs into inventory, the final rule clarifies in part 478 that the serial number need not be immediately recorded if the firearm is being identified by the licensee, or marked under the licensee’s direct supervision, in accordance with § 478.92(a)(2). Once marked, the acquisition entry must be updated. Further, unlike the proposed rule, the final rule expressly allows licensed dealer-gunsmiths, manufacturers, and importers to conduct same-day adjustments or repairs of unmarked PMFs without marking them so long as they do not accept them into inventory overnight and they are returned to the person from whom they were received. If, however, the licensee has possession of the firearm from one day to another or longer, the firearm must be recorded as an “acquisition,” and then as a “disposition” in the A&D records upon return to the same customer. PMFs are thereby treated similarly to commercially produced firearms when same-day adjustments or repairs are conducted. Additionally, the final rule clarifies that a PMF must be recorded as an acquisition whenever it is marked for identification, including same-day or on-the-spot. The only exception is when another licensee places markings for, and under the direct supervision of, the licensee who recorded the acquisition. In that circumstance, the licensee marking the firearm need not enter the PMF as an acquisition or mark the PMF with their own information.

The rule also finalizes with minor changes the proposed amendment to § 479.103 that allows manufacturers to delay submission of an ATF Form 2, Notice of Firearms Manufactured or Imported, if firearm muffler or silencer

parts are transferred between qualified licensees for further manufacture or to complete new devices that are registered upon completion of the device, or to repair existing, registered devices.

#### *J. Record Retention*

This rule finalizes with few changes the proposed requirement in part 478 that all licensees retain their records until business or licensed activity is discontinued, either on paper or in an electronic alternate method approved by the Director, at the business or collection premises readily accessible for inspection. The final rule made changes to § 478.50(a) to make clear that the warehouse for storage of firearms or ammunition inventory may also be used for the storage of records over 20 years of age. The warehouse may not be used to conduct other business activities, which would require a separate license and fee. 18 U.S.C. 923(a).

#### *K. Effect on Prior ATF Rulings and Procedures*

ATF publishes formal rulings and procedures to promote uniform understanding and application of the laws and regulations it administers, and to provide uniform methods for performing operations in compliance with the requirements of the law and regulations. ATF Rulings represent ATF’s guidance as to the application of the law and regulations to the entire state of facts involved, and apply retroactively unless otherwise indicated.<sup>148</sup> Certain ATF Rulings and one ATF Procedure are impacted by this final rule, as follows:

The following rulings are hereby superseded: ATF Ruling 2009–1 (Firearms Manufacturing Activities—Camouflaging or Engraving Firearms); ATF Ruling 2009–5 (Firearms Manufacturing Activities, Identification Markings of Firearms); ATF Ruling 2010–10 (Manufacturing Operations May be Performed by Licensed Gunsmiths Under Certain Conditions); ATF Ruling 2011–1 (Importers Consolidated Records); ATF Ruling 2012–1 (Time Period for Marking Firearms Manufactured); ATF Ruling 2013–3 (Adopting Identification of Firearms); and ATF Ruling 2016–3 (Consolidation of Records Required for Manufacturers).

The following rulings are hereby amplified:<sup>149</sup> ATF Ruling 2002–6

<sup>148</sup> See 27 CFR 70.701(d)(2) (as in effect on January 23, 2003, and continued by 28 CFR 0.133(a)(2), (3)); Rulings, ATF (Oct. 20, 2021), available at <https://www.atf.gov/rules-and-regulations/rulings>.

<sup>149</sup> The term “amplified” is used to describe a situation where no change is being made in a prior

(Identification of Firearms, Armor Piercing Ammunition, and Large Capacity Ammunition Feeding Devices); ATF Ruling 2016–1 (Requirements to Keep Firearms Records Electronically) and ATF Ruling 2016–2 (Electronic ATF Form 4473).

The following rulings and procedure are hereby clarified:<sup>150</sup> Revenue Ruling 55–342 (FFLs Assembling Firearms from Component Parts); ATF Ruling 77–1 (Gunsmithing at Shooting Events); ATF Ruling 2009–2 (Installation of Drop In Replacement Parts); ATF Ruling 2010–3 (Identification of Maxim Side-Plate Receivers); ATF Ruling 2015–1 (Manufacturing and Gunsmithing), and ATF Procedure 2020–1 (Recordkeeping Procedure for Non-Over-the-Counter Firearm Sales By Licensees to Unlicensed In-State Residents That Are NICS Exempt).

#### *L. Severability*

Based on the comments received in opposition to this rule, there is a reasonable possibility that this rule will be subject to litigation challenges. The Department has determined that this rule implements and is fully consistent with governing law. However, in the event any provision of this rule, an amendment or revision made by this rule, or the application of such provision or amendment or revision to any person or circumstance is held to be invalid or unenforceable by its terms, the remainder of this rule, the amendments or revisions made by this rule, and the application of the provisions of such rule to any person or circumstance shall not be affected and shall be construed so as to give them the maximum effect permitted by law.

## **VI. Statutory and Executive Order Review**

### *A. Executive Orders 12866 and 13563*

Executive Orders 13563 (Improving Regulation and Regulatory Review) and 12866 (Regulatory Planning and Review) direct agencies to assess the costs and benefits of available regulatory alternatives and, if regulation is necessary, to select regulatory

published position, but the prior position is being extended to apply to a variation of the fact situation set forth in the new ruling. Thus, if an earlier ruling held that a principle applied to (A), and the new ruling holds that the same principle also applies to (B), the earlier ruling is amplified. See Rulings, ATF (Oct. 20, 2021), available at <https://www.atf.gov/rules-and-regulations/rulings>.

<sup>150</sup> The term “clarified” is used to describe a situation where the language in a prior ruling is being made clear because the language has caused, or may cause, some confusion. It is not used where a position in a prior ruling is being changed. See Rulings, ATF (Oct. 20, 2021), available at <https://www.atf.gov/rules-and-regulations/rulings>.



approaches that maximize net benefits (including potential economic benefits, environmental benefits, public health and safety effects, distributive impacts, and equity). Executive Order 13563 emphasizes the importance of quantifying both costs and benefits, reducing costs, harmonizing rules, and promoting flexibility.

The Office of Information and Regulatory Affairs at OMB has determined that while this final rule is not economically significant, it is a “significant regulatory action” under section 3(f)(4) of Executive Order 12866 because this final rule raises novel legal or policy issues arising out of legal mandates. Accordingly, the rule has been reviewed by OMB.

1. Need for Federal Regulatory Action

In the NPRM, ATF stated that this rule would address externalities. Public comments stated that externalities deal with inefficiencies from market transactions, not actions dealing with the government. ATF concurs that this rule would not address externalities due to market inefficiencies; therefore, to avoid any confusion, ATF has removed language that suggested this rule would address a market inefficiency. Regardless, the publication of this final rule remains necessary to enforce the GCA and NFA.

Agencies take regulatory action for various reasons. One of the reasons is to carry out Congress’s policy decisions, as expressed in statutes. Here, this rulemaking aims to implement Congress’s policy decision to require licensing, marking, recordkeeping, and background checks so that firearms can

be traced if used in crime, and to prevent prohibited persons from acquiring them.

This final rule is necessary to address recent court cases, which have narrowly construed ATF’s current regulatory definition of “frame or receiver.” Such a narrow construction of the regulatory term creates the possibility that future courts may hold that the majority of regulated firearm frames or receivers do not meet the existing definition. Furthermore, administrative inspections, criminal investigations, and prosecutions are hindered when PMFs, which are untraceable, are accepted into and disposed of from a licensee’s inventory, and when firearms records are destroyed after 20 years despite the need of these records to combat criminal activities.

This final rule updates the existing definition of “frame or receiver” to account for technological advances in the industry and ensure that firearms continue to remain under the regulatory regime as intended by the enactment of the GCA, including accounting for manufacturing of firearm parts kits and PMFs made from those kits. The narrow interpretation of what constitutes a “frame or receiver” by some courts may potentially allow persons to avoid: (1) Having to obtain a license to engage in the business of manufacturing or importing frames or receivers; (2) identifying frames or receivers with a serial number and other traceable markings; (3) maintaining records of frames or receivers produced or imported through which they can be

traced; and (4) running NICS checks on potential transferees to determine if they are legally prohibited from receiving or possessing firearms when they acquire frames or receivers. In turn, this would allow otherwise prohibited persons to acquire frames or receivers that can quickly be assembled into semiautomatic weapons easily and without a background check.

If no portion of split or multi-piece frames or receivers were subject to any existing regulations, such as marking, recordkeeping, or background checks, law enforcement’s ability to trace semiautomatic firearms used in the commission of a crime would be severely impeded. This final rule makes consistent the marking requirements for firearms to facilitate tracing in the event a firearm is used in the commission of a crime. In order to accommodate the additional PMF marking requirements, this final rule clarifies and expands the definition of “gunsmithing.” In addition, this final rule requires FFLs to retain all firearms records, either in hard copy or electronically, until the Federal firearms licensed business or licensed activity is discontinued. For more specific details regarding the need for regulation, please refer to the specific chapters of the standalone RIA pertaining to each provision of this final rule.

2. Summary of Affected Population, Costs, and Benefits

Table 2 provides a summary of the affected population and anticipated costs and benefits of promulgating this rule.

TABLE 2—SUMMARY OF AFFECTED POPULATION, COSTS, AND BENEFITS

Category	Final rule
Applicability .....	<ul style="list-style-type: none"> <li>• Definition of Frame or Receiver.</li> <li>• Updates Marking Requirements.</li> <li>• New Gunsmith Definition.</li> <li>• Updates Record Retention.</li> </ul>
Affected Population .....	<ul style="list-style-type: none"> <li>• 113,204 FFLs.</li> <li>• 19,449 FFL Type 07 manufacturers.</li> <li>• 43 Non-FFL manufacturers.</li> <li>• 114,001 FFL dealers, pawnbrokers, and collectors.</li> <li>• 24 Non-FFL dealers.</li> <li>• Approximately 1 million individual owners.</li> </ul>
Total Costs to Industry, Public, and Government (7 percent Discount Rate).	\$14.3 million annualized.
Benefits (7 percent Discount Rate) .....	Not estimated.
Benefits (Qualitative) .....	<ul style="list-style-type: none"> <li>• Provides clarity to courts on what constitutes a firearm frame or receiver.</li> <li>• Adapts to new technology/terminology.</li> <li>• Makes consistent marking requirements.</li> <li>• Eases certain marking requirements.</li> <li>• Increases tracing of crime scene firearms to prosecute criminals.</li> <li>• Restricts felons and other prohibited persons from acquiring PMFs.</li> </ul>

### 3. Changes From the NPRM to FR

Section V of this preamble describes the regulatory text of the final rule and the changes from the proposed rule. The following is a list of substantive changes:

#### (1) Definition of “Frame or Receiver”

- The final rule describes one part of a projectile weapon that will be either the “frame” or “receiver” with examples and pictures still provided.

- The final rule defines “variant” and more clearly grandfathers existing classifications (*e.g.*, AR–15/M–16 variants).

- The final rule clarifies the one part of a firearm muffler or silencer device that is the frame or receiver and addresses how modular silencers are marked.

- The final rule defines “multi-piece frame or receiver” and specifically addresses how such parts must be marked.

- The final rule clarifies the supplement titled “partially complete, disassembled, or inoperable [now ‘nonfunctional’] frame or receiver” and provides examples.

- The final rule clarifies the materials that need to be submitted when voluntarily seeking a firearm or armor piercing ammunition classification from ATF.

#### (2) PMFs

- The final rule requires FFLs to mark and record PMFs only when they are received or otherwise acquired into inventory, but allows PMFs to be adjusted or repaired and returned on the same day without marking.

- The final rule allows FFLs to directly supervise a nonlicensee who may mark the PMF for the licensee in accordance with the regulations.

- The final rule clarifies who is required to be licensed as a gunsmith eligible to mark PMFs without a manufacturer’s license.

#### (3) Marking

- The final rule defines “new design” to inform manufacturers as to when they are required to mark firearms they manufacture in accordance with the new marking requirements (*i.e.*, either FFL name, city, and State; or FFL name and abbreviated FFL number placed on the frame or receiver).

- The final rule expands adoption of marking allowances and addresses an additional three circumstances where markings can be adopted. These include newly manufactured firearms, manufacturers performing gunsmithing services, and PMFs marked by nonlicensees.

- The final rule provides that an acceptable way for PMFs to be marked is by placing the serial number on a metal plate that is permanently embedded into a polymer frame or receiver, or other method approved by the Director.

#### (4) Recordkeeping

- The final rule clarifies that manufacturers have seven days to enter non-NFA firearms into their records, and by close of the next business day for manufactured NFA firearms.

- The final rule clarifies that licensed dealers (including gunsmiths), manufacturers, and importers may conduct adjustments or repairs of all firearms without recording them as acquisitions or dispositions provided they are returned to the person from whom they were received on the same day.

- The final rule clarifies that PMFs must be recorded as an acquisition when a licensee places marks of identification, and as a disposition upon return (unless the licensee is marking under the direct supervision of another licensee who recorded the acquisition).

#### (5) Record Retention

- The final rule clarifies that FFLs are required to maintain their records until licensed activity is discontinued.

#### B. Executive Order 13132

This regulation will not have substantial direct effects on the States, the relationship between the Federal Government and the States, or the distribution of power and responsibilities among the various levels of government. Therefore, in accordance with section 6 of Executive Order 13132 (Federalism), the Attorney General has determined that this regulation does not have sufficient federalism implications to warrant the preparation of a federalism summary impact statement.

#### C. Executive Order 12988

This regulation meets the applicable standards set forth in sections 3(a) and 3(b)(2) of Executive Order 12988 (Civil Justice Reform).

#### D. Regulatory Flexibility Act (“RFA”)

The RFA establishes “as a principle of regulatory issuance that agencies shall endeavor, consistent with the objectives of the rule and of applicable statutes, to fit regulatory and informational requirements to the scale of the businesses, organizations, and governmental jurisdictions subject to regulation. To achieve this principle, agencies are required to solicit and

consider flexible regulatory proposals and to explain the rationale for their actions to assure that such proposals are given serious consideration.” Public Law 96–354, sec. 2(b), 94 Stat. 1164, 1165 (1980).

Under the RFA, the agency is required to consider if this rule will have a significant economic impact on a substantial number of small entities. Agencies must perform a review to determine whether a rule will have such an impact. If the agency determines that it will, the agency must prepare a regulatory flexibility analysis as described in the RFA.

Under the RFA (5 U.S.C. 604(a)), the final regulatory flexibility analysis (“FRFA”) must contain:

- A statement of the need for, and objectives of, the rule;

- a statement of the significant issues raised by the public comments in response to the initial regulatory flexibility analysis, a statement of the assessment of the agency of such issues, and a statement of any changes made in the proposed rule as a result of such comments;

- the response of the agency to any comments filed by the Chief Counsel for Advocacy of the Small Business Administration in response to the proposed rule, and a detailed statement of any change made to the proposed rule in the final rule as a result of the comments;

- a description of and an estimate of the number of small entities to which the rule will apply or an explanation of why no such estimate is available;

- a description of the projected reporting, recordkeeping, and other compliance requirements of the rule, including an estimate of the classes of small entities which will be subject to the requirement and the type of professional skills necessary for preparation of the report or record; and

- a description of the steps the agency has taken to minimize the significant economic impact on small entities consistent with the stated objectives of applicable statutes, including a statement of the factual, policy, and legal reasons for selecting the alternative adopted in the final rule and why each one of the other significant alternatives to the rule considered by the agency that affect the impact on small entities was rejected.

ATF estimates that this final rule will have a significant impact on a substantial number of small businesses. Therefore, ATF has prepared an FRFA. For more details regarding the impacts to small businesses, please refer to the standalone RIA located on the docket.

*E. Small Business Regulatory Enforcement Fairness Act of 1996*

This rule is likely to have a significant economic impact on a substantial number of small entities under the Small Business Regulatory Enforcement Fairness Act of 1996 (“SBREFA”), 5 U.S.C. 601 *et seq.* Accordingly, the Department prepared an initial regulatory flexibility analysis (IRFA) for the proposed rule and prepared an FRFA for the final rule. 5 U.S.C. 603–04. Furthermore, a small business compliance guide will be published as required by SBREFA.

*F. Congressional Review Act*

Pursuant to the Congressional Review Act, 5 U.S.C. 801 *et seq.*, OMB’s Office of Information and Regulatory Affairs has determined this rule is not a “major rule,” as defined by 5 U.S.C. 804(2). This rule will not result in an annual effect on the economy of \$100 million or more; a major increase in costs or prices; or significant adverse effects on competition, employment, investment, productivity, innovation, or on the ability of United States-based enterprises to compete with foreign-based enterprises in domestic and export markets. While there may be impacts on employment, investment, productivity, or innovation, these impacts will not have a significant impact on the overall economy.

*G. Unfunded Mandates Reform Act of 1995*

This rule will not result in the expenditure by State, local, and Tribal governments, in the aggregate, or by the private sector, of \$100 million or more in any one year (adjusted for inflation), and it will not significantly or uniquely affect small governments. Therefore, no actions were deemed necessary under the provisions of the Unfunded Mandates Reform Act of 1995, Public Law 104–4, 109 Stat. 48.

*H. Paperwork Reduction Act of 1995*

This rule would call for collections of information under the Paperwork Reduction Act of 1995, 44 U.S.C. 3501 *et seq.* As defined in 5 CFR 1320.3(c), “collection of information” comprises reporting, recordkeeping, monitoring, posting, labeling, and other similar actions. The title and description of the information collection, a description of those who must collect the information, and an estimate of the total annual burden follow. The estimate covers the time for reviewing instructions, searching existing sources of data, gathering and maintaining the data needed, and completing and reviewing the collection.

Under the provisions of this proposed rule, there is a one-time increase in paperwork burdens of identification markings placed on firearms as well as additional transaction records. This requirement would be added to an existing approved collection covered by OMB control numbers 1140–0018, 1140–0032, 1140–0050, and 1140–0067.

*Title:* Application for a Federal Firearms License.

*OMB Control Number:* OMB 1140–0018.

*Proposed Use of Information:* This collection of information is necessary to ensure that anyone who wishes to be licensed as required by 18 U.S.C. 923 meets the requirements to obtain the desired license.

*Description and Number of Respondents:* Currently there are 13,000 applications for a license. This final rule will effect a one-time increase in one respondent.

*Frequency of Response:* There will be a recurring response for all currently existing FFLs. This final rule would affect a one-time number of one response (13,001 respondents \* 1 response).

*Burden of Response:* This includes recurring time burden of one hour. ATF anticipates a one-time hourly burden of one hour per respondent.

*Estimate of Total Annual Burden:* The current burden listed in this collection of information is 13,000 hours. The new burden, as a result of this final rule, is a one-time hourly burden of 13,001 (13,001 respondents \* 1 time response \* 1 hourly burden per respondent).

*Title:* Records of Acquisition and Disposition, Type 01/02 Dealer of Firearms.

*OMB Control Number:* OMB 1140–0032.

*Proposed Use of Information:* The recordkeeping requirements as contemplated by 18 U.S.C. 923, as amended, are for the primary purpose of facilitating ATF’s authority to inquire into the disposition of any firearm in the course of a criminal investigation, and conduct compliance inspections. Because the regulations require uniform formats for recordkeeping, the records serve a major secondary purpose: Granting ATF Officers the ability to examine records for firearms traces or compliance inspections, per 18 U.S.C. 923(g)(1)(B), (C).

*Description and Number of Respondents:* Currently there are 60,790 respondents. The final rule will not increase the number of respondents, though we anticipate that 116 current respondents will have firearm parts kits and will therefore have an additional burden under this final rule.

*Frequency of Response:* There will be a recurring response for all currently existing Type 01 and Type 02 FFLs. The frequency of response will be dependent on the inventory and sales of FFLs.

*Burden of Response:* The burden of response was estimated at 60,790 hours for inspections. No burden was attributed to entries in records.

*Estimate of Total Annual Burden:* The current burden listed in this collection of information is 60,790 hours. The new burden, as a result of the final rule, is an hourly burden of 116 hours (116 respondents \* 10 items \* 2 responses \* 0.05 hourly burden per entry).

*Title:* Identification Markings Placed on Firearms.

*OMB Control Number:* OMB 1140–0050.

*Proposed Use of Information:* ATF would use this information in fighting crime by facilitating the tracing of firearms used in criminal activities. The systematic tracing of firearms from the manufacturer or U.S. importer to the retail purchaser also enables law enforcement agencies to identify suspects involved in criminal violations, determine if a firearm is stolen, and provide other information relevant to a criminal investigation.

*Description and Number of Respondents:* Currently there are 12,252 licensed manufacturers of firearms and 1,343 licensed importers. Of the potential number of licensed dealers and licensed pawnbrokers, ATF estimates that those directly affected would be a one-time surge of 42 licensed dealers and 74 licensed pawnbrokers. The final rule would affect a one-time surge of 116 respondents.

*Frequency of Response:* There will be a recurring response for all currently existing 13,595 licensed manufacturers and licensed importers. The final rule would affect a one-time number of 1,160 responses (116 one-time respondents \* 10 responses). There will be an annual increase of 101,136 responses (42 respondents \* 2,408 responses).

*Burden of Response:* This includes a recurring time burden of one minute.

*Estimate of Total Annual Burden:* The current burden listed in this collection of information is 85,630 hours. The new burden, as a result of the final rule, is a one-time hourly burden of 19 (116 one-time respondents \* 10 responses \* 0.016667 hourly burden per respondent). The new recurring burden as a result of the final rule is 1,686 hours (42 existing respondents \* 2,408 responses \* 0.016667 hourly burden).

*Title:* Licensed Firearms Manufacturers Records of Production, Disposition, and Supporting Data.

OMB Control Number: OMB 1140–0067.

**Proposed Use of Information:** ATF would use this information for criminal investigation or regulatory compliance with the Gun Control Act of 1968. The Attorney General may inspect or examine the inventory and records of a licensed importer, licensed manufacturer, or licensed dealer, without such reasonable cause or warrant, and during the course of a criminal investigation of a person or persons other than the licensee, in order to ensure compliance with the recordkeeping requirements of 18 U.S.C. 923(g)(1)(A). The Attorney General may also inspect or examine any records relating to firearms involved in a criminal investigation that are traced to the licensee, or firearms that may have been disposed of during the course of a bona fide criminal investigation. 18 U.S.C. 923(g)(1)(B), (C).

**Description and Number of Respondents:** The current number of respondents is 9,056 firearm manufacturers. The final rule will affect a subset of existing respondents (42 respondents).

**Frequency of Response:** There will be a recurring response for all 9,056 licensed manufacturers. The final rule will effect an increase in records of 202,272 responses.

**Burden of Response:** This includes a recurring time burden of 1 minute. The burden resulting from the final rule is 3,371 hours annually.

**Estimate of Total Annual Burden:** The current burden listed in this collection of information is 201,205 hours. The new burden, as a result of the final rule, is 3,371 hours (42 respondents \* 0.016667 hours \* 4,816 responses).

**Disclosure**

Copies of the final rule, proposed rule, and comments received in response to the proposed rule will be available for public inspection through the Federal eRulemaking portal, <http://regulations.gov>, or by appointment during normal business hours at: ATF Reading Room, Room 1E–063, 99 New York Ave. NE, Washington, DC 20226; telephone: (202) 648–8740.

**List of Subjects**

27 CFR Part 447

Administrative practice and procedure, Arms and munitions, Chemicals, Customs duties and inspection, Imports, Penalties, Reporting and recordkeeping requirements, Scientific equipment, Seizures and forfeitures.

27 CFR Part 478

Administrative practice and procedure, Arms and munitions, Exports, Freight, Imports, Intergovernmental relations, Law enforcement officers, Military personnel, Penalties, Reporting and recordkeeping requirements, Research, Seizures and forfeitures, Transportation.

27 CFR Part 479

Administrative practice and procedure, Arms and munitions, Excise taxes, Exports, Imports, Military personnel, Penalties, Reporting and recordkeeping requirements, Seizures and forfeitures, Transportation.

**Authority and Issuance**

Accordingly, for the reasons discussed in the preamble, 27 CFR parts 447, 478, and 479 are amended as follows:

**PART 447—IMPORTATION OF ARMS, AMMUNITION AND IMPLEMENTS OF WAR**

■ 1. The authority citation for 27 CFR part 447 continues to read as follows:

**Authority:** 22 U.S.C. 2778; E.O. 13637, 78 FR 16129 (Mar. 8, 2013).

■ 2. Amend § 447.11 by adding, in alphabetical order, definitions for “Frame or receiver”, and “Privately made firearm”, to read as follows:

**§ 447.11 Meaning of terms.**

\* \* \* \* \*

*Frame or receiver.* The term “frame or receiver” shall have the same meaning as in 27 CFR 478.12.

\* \* \* \* \*

*Privately made firearm.* The term “privately made firearm” shall have the same meaning as in 27 CFR 478.11.

\* \* \* \* \*

**§ 447.42 [Amended]**

■ 3. In § 447.42 amend paragraph (a)(1)(iv)(A) by adding the phrase “of the defense article, or “privately made firearm” (if a firearm privately made in the United States)” after the word “manufacturer”.

**§ 447.45 [Amended]**

■ 4. In § 447.45 amend paragraph (a)(2)(ii) by adding the phrase “, or “privately made firearm” (if a firearm privately made in the United States)” after “defense article”.

**PART 478—COMMERCE IN FIREARMS AND AMMUNITION**

■ 5. The authority citation for 27 CFR part 478 continues to read as follows:

**Authority:** 5 U.S.C. 552(a); 18 U.S.C. 847, 921–931; 44 U.S.C. 3504(h).

■ 6. Amend § 478.11 by:

■ a. In the introductory text, removing the word “section” and adding, in its place, the word “subpart”;

■ b. Adding, in alphabetical order, definitions for “Complete muffler or silencer device” and “Complete weapon”;

■ c. In the definition of “Engaged in the business” revising paragraph (d);

■ d. Revising the definition of “Firearm”;

■ d. Removing the definition of “Firearm frame or receiver”;

■ e. Adding, in alphabetical order, definitions for “Frame or receiver”, “Importer’s or manufacturer’s serial number”, “Privately made firearm (PMF)”, and “Readily”; and

The revisions and additions read as follows:

**§ 478.11 Meaning of terms.**

\* \* \* \* \*

*Complete muffler or silencer device.* A firearm muffler or firearm silencer that contains all component parts necessary to function, whether or not assembled or operable.

*Complete weapon.* A firearm other than a firearm muffler or firearm silencer that contains all component parts necessary to function, whether or not assembled or operable.

\* \* \* \* \*

*Engaged in the business—* \* \* \*

(d) *Gunsmith.* A person who, as a service performed on existing firearms not for sale or distribution, devotes time, attention, and labor to repairing or customizing firearms, making or fitting special barrels, stocks, or trigger mechanisms to firearms, or placing marks of identification on privately made firearms in accordance with this part, as a regular course of trade or business with the principal objective of livelihood and profit, but such term shall not include a person who occasionally repairs or customizes firearms (including identification), or occasionally makes or fits special barrels, stocks, or trigger mechanisms to firearms. In the case of firearms for purposes of sale or distribution, such term shall include a person who performs repairs (e.g., by replacing worn or broken parts) on complete weapons, or places marks of identification on privately made firearms, but shall not include a person who manufactures firearms (i.e., frames or receivers or complete weapons) by completion, assembly, or applying coatings, or otherwise making them suitable for use, requiring a license as a manufacturer;

\* \* \* \* \*

*Firearm.* Any weapon, including a starter gun, which will or is designed to or may readily be converted to expel a projectile by the action of an explosive; the frame or receiver of any such weapon; any firearm muffler or firearm silencer; or any destructive device; but the term shall not include an antique firearm. In the case of a licensed collector, the term shall mean only curios and relics. The term shall include a weapon parts kit that is designed to or may readily be completed, assembled, restored, or otherwise converted to expel a projectile by the action of an explosive. The term shall not include a weapon, including a weapon parts kit, in which the frame or receiver of such weapon is destroyed as described in the definition “frame or receiver”.

\* \* \* \* \*

*Frame or receiver.* The term “frame or receiver” shall have the same meaning as in § 478.12.

\* \* \* \* \*

*Importer’s or manufacturer’s serial number.* The serial number placed by a licensee on a firearm, including any full or abbreviated license number, any such identification on a privately made firearm, or a serial number issued by the Director. For purposes of 18 U.S.C. 922(k) and § 478.34, the term shall include any associated licensee name, or licensee city or State placed on a firearm.

\* \* \* \* \*

*Privately made firearm (PMF).* A firearm, including a frame or receiver, completed, assembled, or otherwise produced by a person other than a licensed manufacturer, and without a serial number placed by a licensed manufacturer at the time the firearm was produced. The term shall not

include a firearm identified and registered in the National Firearms Registration and Transfer Record pursuant to chapter 53, title 26, United States Code, or any firearm manufactured or made before October 22, 1968 (unless remanufactured after that date).

\* \* \* \* \*

*Readily.* A process, action, or physical state that is fairly or reasonably efficient, quick, and easy, but not necessarily the most efficient, speediest, or easiest process, action, or physical state. With respect to the classification of firearms, factors relevant in making this determination include the following:

- (1) Time, *i.e.*, how long it takes to finish the process;
- (2) Ease, *i.e.*, how difficult it is to do so;
- (3) Expertise, *i.e.*, what knowledge and skills are required;
- (4) Equipment, *i.e.*, what tools are required;
- (5) Parts availability, *i.e.*, whether additional parts are required, and how easily they can be obtained;
- (6) Expense, *i.e.*, how much it costs;
- (7) Scope, *i.e.*, the extent to which the subject of the process must be changed to finish it; and
- (8) Feasibility, *i.e.*, whether the process would damage or destroy the subject of the process, or cause it to malfunction.

\* \* \* \* \*

■ 7. Add § 478.12 to subpart B to read as follows:

**§ 478.12 Definition of Frame or Receiver.**

(a) Except as otherwise provided in this section, the term “frame or receiver” means the following—

(1) The term “frame” means the part of a handgun, or variants thereof, that provides housing or a structure for the primary energized component designed to hold back the hammer, striker, bolt, or similar component prior to initiation of the firing sequence (*i.e.*, sear or equivalent), even if pins or other attachments are required to connect such component to the housing or structure.

(2) The term “receiver” means the part of a rifle, shotgun, or projectile weapon other than a handgun, or variants thereof, that provides housing or a structure for the primary component designed to block or seal the breech prior to initiation of the firing sequence (*i.e.*, bolt, breechblock, or equivalent), even if pins or other attachments are required to connect such component to the housing or structure.

(3) The terms “variant” and “variants thereof” mean a weapon utilizing a similar frame or receiver design irrespective of new or different model designations or configurations, characteristics, features, components, accessories, or attachments. For example, an AK-type firearm with a short stock and a pistol grip is a pistol variant of an AK-type rifle, an AR-type firearm with a short stock and a pistol grip is a pistol variant of an AR-type rifle, and a revolving cylinder shotgun is a shotgun variant of a revolver.

(4) The following are nonexclusive examples that illustrate the above definitions:

(i) *Hinged or single framed revolvers:* The frame is the part of the revolver that provides a structure designed to hold the sear.

Figure 1 to paragraph (a)(4)(i)

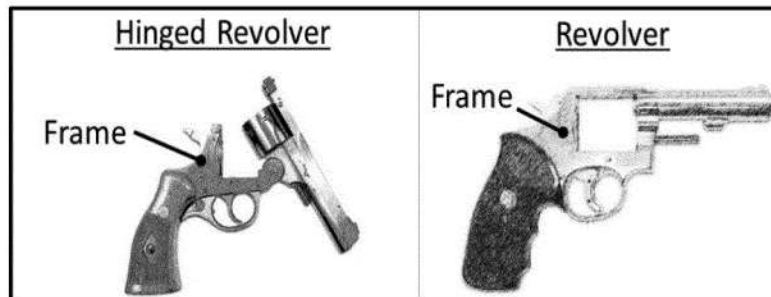

(ii) *Colt 1911, Beretta/Browning/FN Herstal/Heckler & Koch/Ruger/Sig Sauer/Smith & Wesson/Taurus*

*hammer-fired semiautomatic pistols:* The frame is the lower portion of the

pistol, or grip, that provides housing for the sear.

Figure 2 to paragraph (a)(4)(ii)

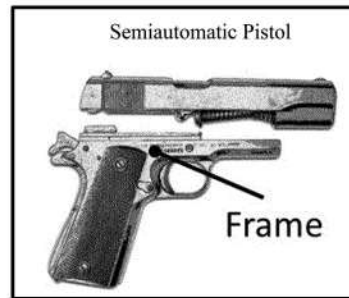

(iii) *Glock variant striker-fired semiautomatic pistols*: The frame is the lower portion of the pistol, or grip, that provides housing for the sear.

Figure 3 to paragraph (a)(4)(iii)

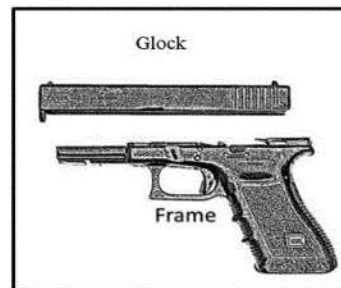

(iv) *Sig Sauer P250/P320 variant semiautomatic pistols*: The frame is the internal removable chassis of the pistol that provides housing for the energized component (*i.e.*, sear or equivalent).

Figure 4 to paragraph (a)(4)(iv)



(v) *Bolt action rifles*: The receiver is the part of the rifle that provides a structure for the bolt.

Figure 5 to paragraph (a)(4)(v)

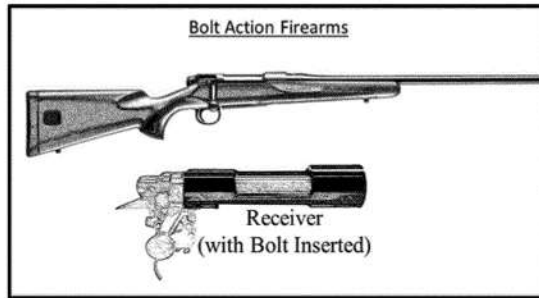

(vi) *Break action, lever action, or pump action rifles and shotguns:* The receiver is the part of the rifle or

shotgun that provides housing for the bolt, breechblock, or equivalent.

Figure 6 to paragraph (a)(4)(vi)

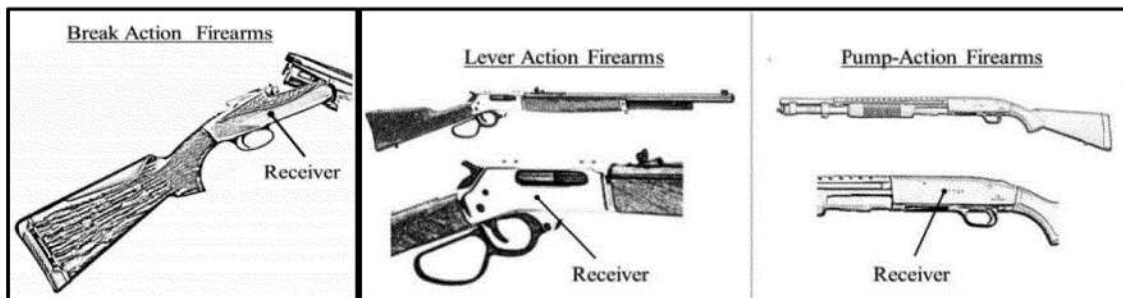

(vii) *AK variant firearms:* The receiver is the part of the weapon that provides housing for the bolt.

Figure 7 to paragraph (a)(4)(vii)

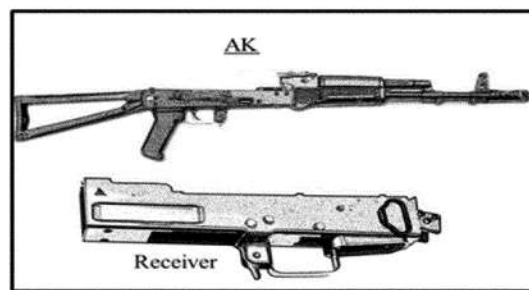

(viii) *Steyr AUG variant firearms:* The receiver is the central part of the

weapon that provides housing for the bolt.

Figure 8 to paragraph (a)(4)(viii)

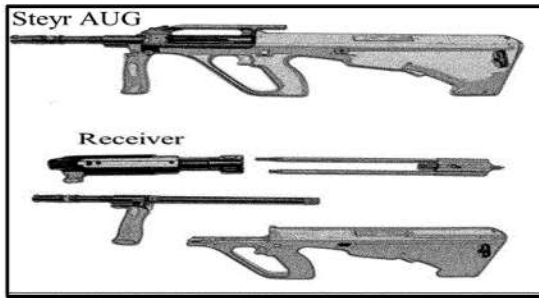

(ix) Thompson machineguns and semiautomatic variants, and L1A1, FN FAL, FN FNC, MP38, MP40, and SIG

550 firearms, and HK machineguns and semiautomatic variants: The receiver is

the upper part of the weapon that provides housing for the bolt.

Figure 9 to paragraph (a)(4)(ix)

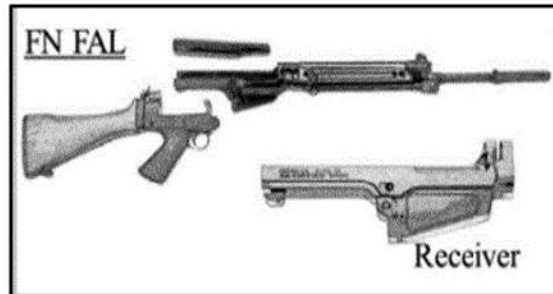
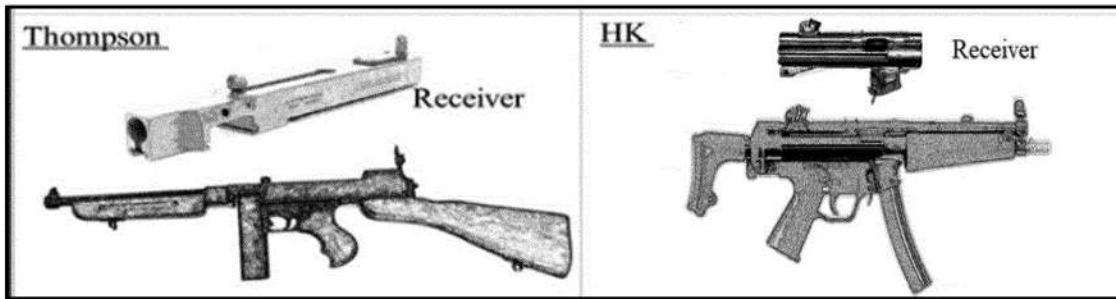

(x) Sten, Sterling, and Kel-Tec SUB-2000 firearms: The receiver is the

central part of the weapon, or tube, that provides housing for the bolt.

Figure 10 to paragraph (a)(4)(x)

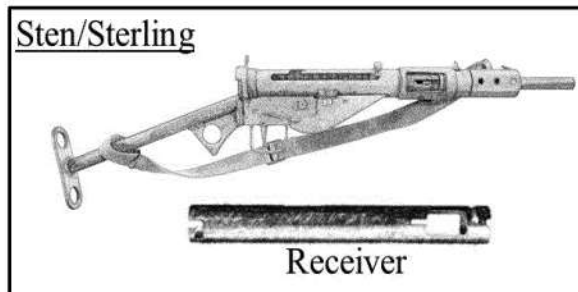



(b) *Firearm muffler or silencer frame or receiver.* The terms “frame” and “receiver” shall mean, in the case of a firearm muffler or firearm silencer, the part of the firearm, such as an outer tube or modular piece, that provides housing or a structure for the primary internal component designed to reduce the sound of a projectile (*i.e.*, baffles, baffling material, expansion chamber, or equivalent). In the case of a modular firearm muffler or firearm silencer device with more than one such part, the terms shall mean the principal housing attached to the weapon that expels a projectile, even if an adapter or other attachments are required to connect the part to the weapon. The terms shall not include a removable end cap of an outer tube or modular piece.

(c) *Partially complete, disassembled, or nonfunctional frame or receiver.* The terms “frame” and “receiver” shall include a partially complete, disassembled, or nonfunctional frame or receiver, including a frame or receiver parts kit, that is designed to or may readily be completed, assembled, restored, or otherwise converted to function as a frame or receiver, *i.e.*, to house or provide a structure for the primary energized component of a handgun, breech blocking or sealing component of a projectile weapon other than a handgun, or internal sound reduction component of a firearm muffler or firearm silencer, as the case may be. The terms shall not include a forging, casting, printing, extrusion, unmachined body, or similar article that has not yet reached a stage of manufacture where it is clearly identifiable as an unfinished component part of a weapon (*e.g.*, unformed block of metal, liquid polymer, or other raw material). When issuing a classification, the Director may consider any associated templates, jigs, molds, equipment, tools, instructions, guides, or marketing materials that are sold, distributed, or possessed with the item or kit, or otherwise made available by the seller or distributor of the item or kit to the purchaser or recipient of the item

or kit. The following are nonexclusive examples that illustrate the definitions:

*Example 1 to paragraph (c)—Frame or receiver:* A frame or receiver parts kit containing a partially complete or disassembled billet or blank of a frame or receiver that is sold, distributed, or possessed with a compatible jig or template is a frame or receiver, as a person with online instructions and common hand tools may readily complete or assemble the frame or receiver parts to function as a frame or receiver.

*Example 2 to paragraph (c)—Frame or receiver:* A partially complete billet or blank of a frame or receiver with one or more template holes drilled or indexed in the correct location is a frame or receiver, as a person with common hand tools may readily complete the billet or blank to function as a frame or receiver.

*Example 3 to paragraph (c)—Frame or receiver:* A complete frame or receiver of a weapon that has been disassembled, damaged, split, or cut into pieces, but not destroyed in accordance with paragraph (e), is a frame or receiver.

*Example 4 to paragraph (c)—Not a receiver:* A billet or blank of an AR-15 variant receiver without critical interior areas having been indexed, machined, or formed that is not sold, distributed, or possessed with instructions, jigs, templates, equipment, or tools such that it may readily be completed is not a receiver.

*Example 5 to paragraph (c)—Not a receiver:* A flat blank of an AK variant receiver without laser cuts or indexing that is not sold, distributed, or possessed with instructions, jigs, templates, equipment, or tools is not a receiver, as a person cannot readily fold the flat to provide housing or a structure for the primary component designed to block or seal the breech prior to initiation of the firing sequence.

(d) *Multi-piece frame or receiver.* The term “multi-piece frame or receiver” shall mean a frame or receiver that may be disassembled into multiple modular subparts, *i.e.*, standardized units that may be replaced or exchanged. The term shall not include the internal frame of

a pistol that is a complete removable chassis that provides housing for the energized component, unless the chassis itself may be disassembled. The modular subpart(s) identified in accordance with § 478.92 with an importer’s or manufacturer’s serial number shall be presumed, absent an official determination by the Director or other reliable evidence to the contrary, to be part of the frame or receiver of a weapon or device.

(e) *Destroyed frame or receiver.* The terms “frame” and “receiver” shall not include a frame or receiver that is destroyed. For purposes of these definitions, the term “destroyed” means that the frame or receiver has been permanently altered such that it may not readily be completed, assembled, restored, or otherwise converted to function as a frame or receiver. Acceptable methods of destruction include completely melting, crushing, or shredding the frame or receiver, or other method approved by the Director.

(f)(1) *Frame or receiver classifications based on which part of the weapon was classified as such before April 26, 2022.* Except as provided in paragraph (f)(2) of this section, the terms “frame” and “receiver” shall include the specific part of a complete weapon, including variants thereof, determined (classified) by the Director to be defined as a firearm frame or receiver prior to April 26, 2022. Any such part that is identified with an importer’s or manufacturer’s serial number shall be presumed, absent an official determination by the Director or other reliable evidence to the contrary, to be the frame or receiver of the weapon. The following is a nonexclusive list of such weapons and the specific part determined by the Director to be the firearm frame or receiver as they existed on that date:

(i) *AR-15/M-16 variant firearms:* The receiver is the lower part of the weapon that provides housing for the trigger mechanism and hammer (*i.e.*, lower receiver).

Figure 11 to paragraph (f)(1)(i)

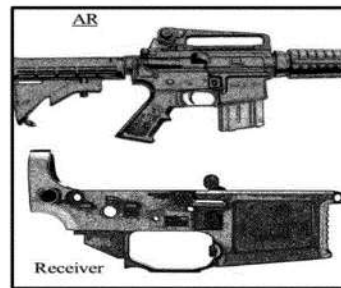

(ii) *Ruger Mark IV pistol*: The frame is the upper part of the weapon that provides housing for the bolt or breechblock.

Figure 12 to paragraph (f)(1)(ii)

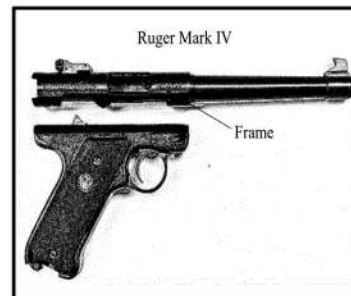

(iii) *Benelli 121 M1 Shotgun*: The receiver is the lower part of the weapon that provides housing for the trigger mechanism.

Figure 13 to paragraph (f)(1)(iii)

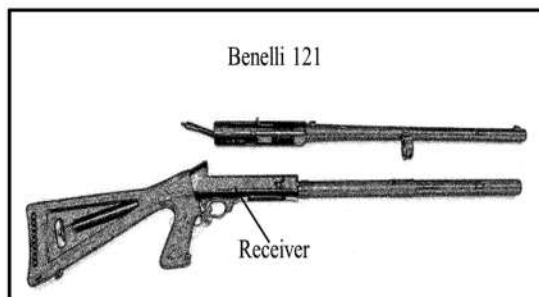

(iv) *Vickers/Maxim, Browning 1919, M2, and box-type machineguns and semiautomatic variants*: The receiver is the side plate of the weapon that is designed to hold the charging handle.

Figure 14 to paragraph (f)(1)(iv)

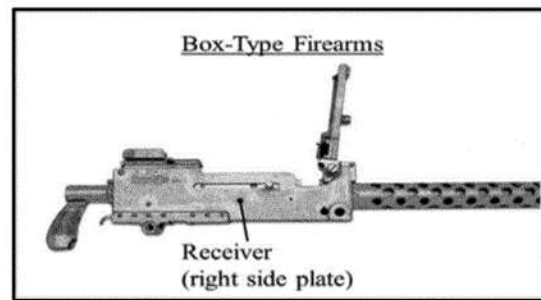

(2) *Frame or receiver classifications of partially complete, disassembled, or nonfunctional frames or receivers before April 26, 2022.* Prior determinations by the Director that a partially complete, disassembled, or nonfunctional frame or receiver, including a parts kit, was not, or did not include, a “firearm frame or receiver” under § 478.11, or “frame or receiver” under § 479.11 of this subchapter, as those terms were defined prior to April 26, 2022, shall not continue to be valid or authoritative after that date. Such determinations shall include those in which the Director determined that the item or parts kit had not yet reached a stage of manufacture to be, or include, a “firearm frame or receiver” under § 478.11, or “frame or receiver” under § 479.11 of this subchapter, as those terms were defined prior to [date of publication of the rule].

**§ 478.47 [Amended]**

■ 8. In § 478.47 amend paragraph (a) by removing the words “serial number” and adding in its place “unique license number”.

**§ 478.50 [Amended]**

■ 9. In § 478.50 amend paragraph (a) by adding the phrase “, or if such warehouse is used by the licensee for the storage of records as provided in § 478.129” after the phrase “at the licensed premises served by such warehouse”.

**§ 478.92 [Amended]**

■ 10. Amend § 478.92 by revising paragraph (a) and adding paragraph (c) to read as follows:

**§ 478.92 Identification of firearms and armor piercing ammunition.**

(a)(1) *Firearms manufactured or imported by licensees.* Except as otherwise provided in this section, licensed manufacturers and licensed importers of firearms must legibly identify each firearm they manufacture or import as follows:

(i) *Serial number, name, place of business.* By engraving, casting, stamping (impressing), or otherwise conspicuously placing or causing to be engraved, cast, stamped (impressed) or otherwise placed on the frame or receiver thereof, an individual serial number, in a manner not susceptible of being readily obliterated, altered, or removed. The serial number must not duplicate any serial number placed by the licensee on any other firearm. The frame or receiver must also be marked with either: their name (or recognized abbreviation), and city and State (or recognized abbreviation) where they maintain their place of business; or their name (or recognized abbreviation) and the serial number beginning with their abbreviated Federal firearms license number, which is the first three and last five digits, as a prefix to the unique identification number, followed by a hyphen, *e.g.*, “12345678-[unique identification number]”; and

(ii) *Model, caliber or gauge, foreign manufacturer, country of manufacture.* By engraving, casting, stamping (impressing), or otherwise conspicuously placing or causing to be engraved, cast, stamped (impressed) or placed on the frame or receiver, or barrel or pistol slide (if applicable) thereof, certain additional information. This information must be placed in a manner not susceptible of being readily obliterated, altered, or removed. The additional information shall include:

(A) The model, if such designation has been made;

(B) The caliber or gauge;

(C) When applicable, the name of the foreign manufacturer; and

(D) In the case of an imported firearm, the name of the country in which it was manufactured. For additional requirements relating to imported firearms, see Customs regulations at 19 CFR part 134.

(iii) *Multi-piece frame or receiver.* In the case of a multi-piece frame or receiver, the modular subpart that is the outermost housing or structure designed

to house, hold, or contain either the primary energized component of a handgun, breech blocking or sealing component of a projectile weapon other than a handgun, or internal sound reduction component of a firearm muffler or firearm silencer, as the case may be, shall be the subpart of the multi-piece frame or receiver identified in accordance with this section. If more than one subpart is similarly designed to house, hold, or contain such primary component (*e.g.*, left and right halves), each of those subparts must be identified with the same serial number and associated licensee information not duplicated on any other frame or receiver. The identified subpart(s) of a complete (assembled or unassembled) multi-piece frame or receiver shall not be removed and replaced (*see* § 478.34, 18 U.S.C. 922(k), and 26 U.S.C. 5861(g) and (h)), unless—

(A) The subpart replacement is not a firearm under 26 U.S.C. 5845;

(B) The subpart replacement is identified by the licensed manufacturer of the original subpart with the same serial number and associated licensee information in the manner prescribed by this section; and

(C) The original subpart is destroyed under the licensed manufacturer's control or direct supervision prior to such placement.

(iv) *Frame or receiver, machinegun conversion part, or muffler or silencer part disposed of separately.* Each part defined as a frame or receiver or modular subpart thereof described in paragraph (a)(1)(iii) of this section, machinegun, or firearm muffler or firearm silencer that is not a component part of a complete weapon or complete muffler or silencer device at the time it is sold, shipped, or otherwise disposed of by the licensee must be identified as required by this section with an individual serial number not duplicated on any other firearm and all additional identifying information, except that the model designation and caliber or gauge may be omitted if that information is

unknown at the time the part is identified.

(v) *Size and depth of markings.* The engraving, casting, or stamping (impressing) of the serial number and additional information must be to a minimum depth of .003 inch, and the serial number and any associated license number in a print size no smaller than  $\frac{1}{16}$  inch. The size of the serial and license number is measured as the distance between the latitudinal ends of the character impression bottoms (bases). The depth of all markings required by this section is measured from the flat surface of the metal and not the peaks or ridges.

(vi) *Period of time to identify firearms.* Licensed manufacturers shall identify firearms they manufacture within the period of time set forth in the following subparagraphs (A) and (B), and licensed importers must identify firearms they import within the period prescribed in § 478.112. For purposes of these subparagraphs, firearms awaiting materials, parts, or equipment repair to be completed are presumed, absent reliable evidence to the contrary, to be in the manufacturing process.

(A) *Complete non-National Firearms Act weapons, and frames or receivers of such weapons.* Complete weapons not defined as firearms under 26 U.S.C. 5845 shall be identified not later than the seventh day following the date the entire manufacturing process has ended for the weapon, or prior to disposition, whichever is sooner. Each part, including a replacement part, defined as a frame or receiver or modular subpart thereof described in paragraph (a)(1)(iii) of this section (other than a machinegun or firearm muffler or firearm silencer) that is not a component part of a complete weapon at the time it is sold, shipped, or otherwise disposed of shall be identified not later than the seventh day following the date the entire manufacturing process has ended for the frame or receiver or modular subpart, or prior to disposition, whichever is sooner.

(B) *Complete National Firearms Act weapons and devices, and machinegun and muffler or silencer parts.* Complete weapons defined as firearms under 26 U.S.C. 5845, and complete muffler or silencer devices, shall be identified not later than close of the next business day following the date the entire manufacturing process has ended for the weapon or device, or prior to disposition, whichever is sooner. Each part or modular subpart defined as a machinegun (*i.e.*, frame or receiver or conversion part), or firearm muffler or firearm silencer, that is not a component part of a complete weapon or complete

firearm muffler or silencer device at the time it is sold, shipped, or otherwise disposed of shall be identified not later than close of the next business day following the date the entire manufacturing process has ended for the part, or prior to disposition, whichever is sooner.

(2) *Privately made firearms (PMFs).* Unless previously identified by another licensee in accordance with, and except as otherwise provided by, this section, licensees must legibly and conspicuously identify each privately made firearm or “PMF” received or otherwise acquired (including from a personal collection) not later than the seventh day following the date of receipt or other acquisition, or before the date of disposition (including to a personal collection), whichever is sooner. PMFs must be identified by placing, or causing to be placed under the licensee’s direct supervision, an individual serial number on the frame or receiver, which must not duplicate any serial number placed by the licensee on any other firearm. The serial number must begin with the licensee’s abbreviated Federal firearms license number, which is the first three and last five digits, as a prefix to a unique identification number, followed by a hyphen, *e.g.*, “12345678-[unique identification number]”. The serial number must be placed in a manner otherwise in accordance with this section, including the requirements that the serial number be at the minimum size and depth, and not susceptible of being readily obliterated, altered, or removed. An acceptable method of identifying a PMF is by placing the serial number on a metal plate that is permanently embedded into a polymer frame or receiver, or other method approved by the Director.

(3) *Meaning of marking terms.* For purposes of this section, the term “identify” means placing marks of identification, the terms “legible” and “legibly” mean that the identification markings (including a unique identification number) use exclusively Roman letters (*e.g.*, A, a, B, b, C, c) and Arabic numerals (*e.g.*, 1, 2, 3), or solely Arabic numerals, and may include a hyphen, and the terms “conspicuous” and “conspicuously” mean that the identification markings are capable of being easily seen with the naked eye during normal handling of the firearm, and are unobstructed by other markings when the complete weapon or device is assembled.

(4) *Exceptions—(i) Alternate means of identification.* The Director may authorize other means of identification to identify firearms upon receipt of a

letter application or prescribed form from the licensee showing that such other identification is reasonable and will not hinder the effective administration of this part.

(ii) *Destructive devices.* In the case of a destructive device, the Director may authorize other means of identification to identify that weapon upon receipt of a letter application or prescribed form from the licensee. The application shall show that engraving, casting, or stamping (impressing) such a weapon as required by this section would be dangerous or impracticable and that the alternate means of identification proposed will not hinder the effective administration of this part.

(iii) *Adoption of identifying markings.* Licensees may adopt existing markings previously placed on a firearm and are not required to mark a serial number or other identifying markings in accordance with this section, as follows:

(A) *Newly manufactured firearms:* Licensed manufacturers may adopt the serial number and other identifying markings previously placed on a firearm by another licensed manufacturer provided the firearm has not been sold, shipped, or otherwise disposed of to a person other than a licensee, and the serial number adopted is not duplicated on any other firearm.

(B) *Remanufactured or imported firearms.* Licensed manufacturers and licensed importers may adopt the serial number or other identifying markings previously placed on a firearm that otherwise meets the requirements of this section that has been sold, shipped, or otherwise disposed of to a person other than a licensee provided that, within the period and in the manner herein prescribed, the licensee legibly and conspicuously places, or causes to be placed, on the frame or receiver either: Their name (or recognized abbreviation), and city and State (or recognized abbreviation) where they maintain their place of business; or their name (or recognized abbreviation) and abbreviated Federal firearms license number, which is the first three and last five digits, individually (*i.e.*, not as a prefix to the serial number adopted) after the letters “FFL”, in the following format: “FFL12345678”. The serial number adopted must not duplicate any serial number adopted or placed on any other firearm, except that if a licensed importer receives two or more firearms with the same foreign manufacturer’s serial number, the importer may adopt the serial number by adding letters or numbers to that serial number, and may include a hyphen.

(C) *Manufacturers performing gunsmithing services.* Licensed

manufacturers may adopt the serial number or other identifying markings previously placed on a firearm by another licensee provided the manufacturer is performing services for a nonlicensee as a gunsmith (as defined in § 478.11) on existing firearms not for sale or distribution.

(D) *Privately made firearms marked by nonlicensees.* Unless previously identified by another licensee in accordance with this section, licensees may adopt a unique identification number previously placed on a privately made firearm by an unlicensed person, but not duplicated on any other firearm of the licensee, that otherwise meets the identification requirements of this section provided that, within the period and in the manner herein prescribed, the licensee legibly and conspicuously places, or causes to be placed, on the frame or receiver thereof a serial number beginning with their abbreviated Federal firearms license number, which is the first three and last five digits, followed by a hyphen, before the existing unique identification number, e.g., “12345678-[unique identification number]”.

(iv)(A) *Firearm muffler or silencer parts transferred between qualified manufacturers for further manufacture or to complete new devices.* Licensed manufacturers qualified under 27 CFR part 479 may transfer a part defined as a firearm muffler or firearm silencer to another qualified manufacturer without immediately identifying or registering such part provided that it is for further manufacture (i.e., machining, coating, etc.) or manufacturing a complete muffler or silencer device. Once the new device with such part is completed, the manufacturer who completes the device shall identify, record, and register it in the manner and within the period specified in this part for a complete muffler or silencer device.

(B) *Firearm muffler or silencer replacement parts transferred to qualified manufacturers or dealers to repair existing devices.* Licensed manufacturers qualified under part 479 may transfer a replacement part defined as a firearm muffler or firearm silencer other than a frame or receiver to a qualified manufacturer or dealer without identifying or registering such part provided that it is for repairing a complete muffler or silencer device that was previously identified, recorded, and registered in accordance with this part and part 479.

(v) *Frames or receivers designed before August 24, 2022.* Licensed manufacturers and licensed importers may continue to identify the same component of a firearm (other than a

PMF) defined as a frame or receiver as it existed before August 24, 2022 with the same information required to be marked by paragraphs (a)(1)(i) and (a)(1)(ii) of this section that were in effect prior to that date, and any rules necessary to ensure such identification shall remain effective for that purpose. Any frame or receiver with a new design manufactured after August 24, 2022 must be marked with the identifying information and within the period prescribed by this section. For purposes of this paragraph, the term “new design” means that the design of the existing frame or receiver has been functionally modified or altered, as distinguished from performing a cosmetic process that adds to or changes the decoration of the frame or receiver (e.g., painting or engraving), or by adding or replacing stocks, barrels, or accessories to the frame or receiver.

(vi) *Privately made firearms acquired before August 24, 2022.* Licensees shall identify in the manner prescribed by this section, or cause another person to so identify, each privately made firearm received or otherwise acquired (including from a personal collection) by the licensee before August 24, 2022 within sixty (60) days from that date, or prior to the date of final disposition (including to a personal collection), whichever is sooner.

\* \* \* \* \*

(c) *Voluntary classification of firearms and armor piercing ammunition.* The Director may issue a determination (classification) to a person whether an item, including a kit, is a firearm or armor piercing ammunition as defined in this part upon receipt of a written request or form prescribed by the Director. Each such voluntary request or form submitted shall be executed under the penalties of perjury with a complete and accurate description of the item or kit, the name and address of the manufacturer or importer thereof, and a sample of such item or kit for examination. A firearm sample must include all accessories and attachments relevant to such classification as each classification is limited to the firearm in the configuration submitted. Each request for classification of a partially complete, disassembled, or nonfunctional item or kit must contain any associated templates, jigs, molds, equipment, or tools that are made available by the seller or distributor of the item or kit to the purchaser or recipient of the item or kit, and any instructions, guides, or marketing materials if they will be made available by the seller or distributor with the item or kit. Upon completion of the

examination, the Director may return the sample to the person who made the request unless a determination is made that return of the sample would be or place the person in violation of law. Submissions of armor piercing ammunition with a projectile or projectile core constructed entirely from one or a combination of tungsten steel alloys, steel, iron, brass, bronze, beryllium copper, or depleted uranium must include a list of known handguns in which the ammunition may be used. Except for the classification of a specific component as the frame or receiver of a particular weapon, a determination made by the Director under this paragraph shall not be deemed by any person to be applicable to or authoritative with respect to any other sample, design, model, or configuration.

■ 11. Revise § 478.122 to read as follows:

**§ 478.122 Records maintained by importers.**

(a) Except for adjustment or repair of a firearm that is returned to the person from whom it was received on the same day, each licensed importer shall record the name of the importer and manufacturer, type, model, caliber or gauge, country or countries of manufacture (if imported), and serial number (including any associated license number either as a prefix, or if remanufactured or imported, separated by a semicolon) of each firearm imported or otherwise acquired (including a frame or receiver to be disposed of separately), the date of such importation or other acquisition, and if otherwise acquired, the name and address, or the name and license number of the person from whom it was received. Privately made firearms shall be recorded in accordance with § 478.125(i). The information required by this paragraph shall be recorded not later than 15 days following the date of importation or other acquisition in a format containing the applicable columns set forth in paragraph (b) of this section.

(b) A record of each firearm disposed of by an importer and a separate record of armor piercing ammunition dispositions to governmental entities, for exportation, or for testing or experimentation authorized under the provisions of § 478.149 shall be maintained by the licensed importer on the licensed premises. The record shall show the date of such sale or other disposition, and the name and license number of the licensee to whom the firearm was transferred, or if disposed of to a nonlicensee, the name and address of the person, or the transaction number

of the Firearms Transaction Record, Form 4473, if the licensee transferring the firearm sequentially numbers the Forms 4473 and files them numerically. In the event the licensee records a duplicate entry with the same firearm and acquisition information, whether to close out an old record book or for any

other reason, the licensee shall record a reference to the date and location of the subsequent entry (e.g., date of new entry, book name/number, page number, and line number) as the disposition. The information required by this paragraph (b) shall be entered in the proper record book not later than the seventh day

following the date of the transaction. Such information shall be recorded in formats containing the applicable columns below, except that for armor piercing ammunition, the information and format shall also include the quantity of projectiles:

TABLE 1 TO PARAGRAPH (b)—FIREARMS IMPORTER OR MANUFACTURER ACQUISITION AND DISPOSITION RECORD

Description of firearm					Import/manufacture/acquisition		Disposition			
Importer, manufacturer, and/or "privately made firearm" (PMF) (if privately made in the U.S.)	Type	Model	Caliber or gauge	Country or countries of manufacture (if imported)	Serial No.	Date of import, manufacture, or acquisition	Name and address of nonlicensee; or if licensee, name and license No. (if acquired)	Date of disposition	Name	Address of nonlicensee; license No. of licensee; or Form 4473 transaction No. if such forms filed numerically

TABLE 2 TO PARAGRAPH (b)—ARMOR PIERCING AMMUNITION IMPORTER OR MANUFACTURER DISPOSITION RECORD

Date of disposition	Manufacturer	Caliber or gauge	Quantity of projectiles	Transferee—name and address
---------------------	--------------	------------------	-------------------------	-----------------------------

(c) The Director may authorize alternate records to be maintained by a licensed importer to record the acquisition and disposition of firearms and armor piercing ammunition when it is shown by the licensed importer that such alternate records will accurately and readily disclose the information required by this section. A licensed importer who proposes to use alternate records shall submit a letter application to the Director and shall describe the proposed alternate records and the need therefor. Such alternate records shall not be employed by the licensed importer until approval in such regard is received from the Director.

■ 12. Revise § 478.123 to read as follows:

**§ 478.123 Records maintained by manufacturers.**

(a) Except for adjustment or repair of a firearm that is returned to the person from whom it was received on the same day, each licensed manufacturer shall record the name of the manufacturer and importer (if any), type, model, caliber or gauge, and serial number (including any associated license number either as a prefix, or if remanufactured or imported, separated by a semicolon) of each firearm manufactured or otherwise acquired (including a frame or receiver to be disposed of separately), the date of such manufacture or other acquisition, and if otherwise acquired, the name and address or the name and license number of the person from whom it was received. Privately made firearms shall be recorded in accordance with

§ 478.125(i). The information required by this paragraph shall, in the case of a firearm other than a firearm defined in 26 U.S.C. 5845, be recorded not later than the seventh day following the date of such manufacture or other acquisition. In the case of a firearm defined in 26 U.S.C. 5845, such information shall be recorded by close of the next business day following the date of such manufacture or other acquisition, except that, when a commercial record is held by the licensed manufacturer separately from other commercial documents and readily available for inspection, containing all acquisition information required for the record, the period for making the required entry into the record may be delayed not to exceed the seventh day following the date of receipt. The information required by this paragraph shall be recorded in a format containing the applicable columns prescribed by § 478.122.

(b) A record of each firearm disposed of by a manufacturer and a separate record of armor piercing ammunition dispositions to governmental entities, for exportation, or for testing or experimentation authorized under the provisions of § 478.149 shall be maintained by the licensed manufacturer on the licensed premises. The record shall show the date of such sale or other disposition, and the name and license number of the licensee to whom the firearms were transferred, or if disposed of to a nonlicensee, the name and address of the person, or the transaction number of the Firearms Transaction Record, Form 4473, if the

licensee transferring the firearm sequentially numbers the Forms 4473 and files them numerically. In the event the licensee records a duplicate entry with the same firearm and acquisition information, whether to close out an old record book or for any other reason, the licensee shall record a reference to the date and location of the subsequent entry (e.g., date of new entry, book name/number, page number, and line number) as the disposition. The information required by this paragraph shall be entered in the proper record book not later than the seventh day following the date of the transaction. Such information shall be recorded in a format containing the applicable columns prescribed by § 478.122, except that for armor piercing ammunition, the information and format shall also include the quantity of projectiles.

(c) The Director may authorize alternate records to be maintained by a licensed manufacturer to record the acquisition or disposition of firearms and armor piercing ammunition when it is shown by the licensed manufacturer that such alternate records will accurately and readily disclose the information required by this section. A licensed manufacturer who proposes to use alternate records shall submit a letter application to the Director and shall describe the proposed alternate record and the need therefor. Such alternate records shall not be employed by the licensed manufacturer until approval in such regard is received from the Director.

■ 13. Amend § 478.124 by:

- a. In paragraph (b) removing the word “serial” before “number”;
- b. Revising paragraph (c)(4); and
- c. In paragraph (f) revising the fourth sentence and adding a new fifth sentence.

The addition and revision read as follows:

**§ 478.124 Firearms transaction record.**

(c) The licensee shall identify the firearm to be transferred by listing on the Form 4473 the name of the manufacturer, the name of the importer (if any), the type, model, caliber or gauge, and the serial number (including any associated license number either as a prefix, or if remanufactured or imported, separated by a semicolon) of the firearm. Where no manufacturer name has been identified on a privately made firearm, the words “privately made firearm” (or abbreviation “PMF”) shall be recorded as the name of the manufacturer.

(f) The licensee shall identify the firearm to be transferred by listing in the Forms 4473 the name of the manufacturer, the name of the importer (if any), the type, model, caliber or gauge, and the serial number of the firearm to be transferred. Where no manufacturer name has been identified on a privately made firearm, the words “privately made firearm” (or abbreviation “PMF”) shall be recorded as the name of the manufacturer.

- 14. Amend § 478.125 by revising paragraphs (e), (f) and (i) to read as follows:

**§ 478.125 Record of receipt and disposition.**

(e) *Firearms receipt and disposition by dealers.* Except for adjustment or repair of a firearm that is returned to the person from whom it was received on the same day, each licensed dealer shall enter into a record each receipt and disposition of firearms. In addition, before commencing or continuing a firearms business, each licensed dealer shall inventory the firearms possessed for such business and shall record the same in the record required by this paragraph. The record required by this paragraph shall be maintained in bound form in the format prescribed below. The purchase or other acquisition of a firearm shall, except as provided in paragraphs (g) and (i) of this section, be recorded not later than the close of the next business day following the date of such purchase or acquisition. The record shall show the date of receipt, the name and address or the name and license number of the person from whom received, the name of the manufacturer and importer (if any), the model, serial number (including any associated license number either as a prefix, or if remanufactured or imported, separated by a semicolon), type, and the caliber or gauge of the firearm. In the event the licensee records a duplicate entry with the same firearm and acquisition information,

whether to close out an old record book or for any other reason, the licensee shall record a reference to the date and location of the subsequent entry (e.g., date of new entry, book name/number, page number, and line number) as the disposition. The sale or other disposition of a firearm shall be recorded by the licensed dealer not later than seven days following the date of such transaction. When such disposition is made to a nonlicensee, the firearms transaction record, Form 4473, obtained by the licensed dealer shall be retained, until the transaction is recorded, separate from the licensee’s Form 4473 file and be readily available for inspection. When such disposition is made to a licensee, the commercial record of the transaction shall be retained, until the transaction is recorded, separate from other commercial documents maintained by the licensed dealer, and be readily available for inspection. The record shall show the date of the sale or other disposition of each firearm, the name and address of the person to whom the firearm is transferred, or the name and license number of the person to whom transferred if such person is a licensee, or the firearms transaction record, Form 4473, transaction number if the licensed dealer transferring the firearm sequentially numbers the Forms 4473 and files them numerically. The format required for the record of receipt and disposition of firearms is as follows:

TABLE 2 TO PARAGRAPH (e)—FIREARMS DEALER ACQUISITION AND DISPOSITION RECORD

Description of firearm					Receipt		Disposition		
Manufacturer, importer (if any), or “privately made firearm” (PMF)	Model	Serial No.	Type	Caliber or gauge	Date	Name and address of nonlicensee; or if licensee, name and license No.	Date	Name	Address of nonlicensee; license No. of licensee; or Form 4473 transaction No. if such forms filed numerically

(f) *Firearms receipt and disposition by licensed collectors.* (1) Each licensed collector shall enter into a record each receipt and disposition of firearms curios or relics. The record required by this paragraph shall be maintained in bound form under the format prescribed below. The purchase or other acquisition of a curio or relic shall, except as provided in paragraphs (g) and (i) of this section, be recorded not later than the close of the next business day following the date of such purchase or other acquisition. The record shall show the date of receipt, the name and address or the name and license number of the person from whom received, the

name of the manufacturer and importer (if any), the model, serial number (including any associated license number either as a prefix, or if remanufactured or imported, separated by a semicolon), type, and the caliber or gauge of the firearm curio or relic. In the event the licensee records a duplicate entry with the same firearm and acquisition information, whether to close out an old record book or for any other reason, the licensee shall record a reference to the date and location of the subsequent entry (e.g., date of new entry, book name/number, page number, and line number) as the disposition. The sale or other disposition of a curio or

relic shall be recorded by the licensed collector not later than seven days following the date of such transaction. When such disposition is made to a licensee, the commercial record of the transaction shall be retained, until the transaction is recorded, separate from other commercial documents maintained by the licensee, and be readily available for inspection. The record shall show the date of the sale or other disposition of each firearm curio or relic, the name and address of the person to whom the firearm curio or relic is transferred, or the name and license number of the person to whom transferred if such person is a licensee,

and the date of birth of the transferee if other than a licensee. In addition, the licensee shall cause the transferee, if other than a licensee, to be identified in

any manner customarily used in commercial transactions (e.g., a driver's license), and note on the record the method used.

(2) The format required for the record of receipt and disposition of firearms by collectors is as follows:

TABLE 3 TO PARAGRAPH (f)(2)—FIREARMS COLLECTOR ACQUISITION AND DISPOSITION RECORD

Description of firearm					Receipt		Disposition			
Manufacturer, importer (if any), or "privately made firearm" (PMF)	Model	Serial No.	Type	Caliber or gauge	Date	Name and address of nonlicensee; or if licensee, name and license No.	Date	Name and address of nonlicensee; or if licensee, name and license No.	Date of birth if nonlicensee	Driver's license No. or other identification if nonlicensee

\* \* \* \* \*

(i) *Privately made firearms.* Except for adjustment or repair of a firearm that is returned to the person from whom it was received on the same day, licensees must record each receipt or other acquisition (including from a personal collection) and disposition (including to a personal collection) of a privately made firearm as required by this part. For purposes of this paragraph, the terms "receipt" and "acquisition" shall include same-day or on-the-spot placement of identifying markings unless another licensee is placing the markings for, and under the direct supervision of, the licensee who recorded the acquisition. In that case, the licensee placing the markings need not record an acquisition from the supervising licensee or disposition upon

return. The serial number need not be immediately recorded if the firearm is being identified by the licensee, or under the licensee's direct supervision with the licensee's serial number, in accordance with § 478.92(a)(2). Once the privately made firearm is so identified, the licensee shall update the record of acquisition entry with the serial number, including the license number prefix, and shall record its disposition in accordance with this section. In this part and part 447, where no manufacturer name has been identified on a privately made firearm (if privately made in the United States), the words "privately made firearm" (or abbreviation "PMF") shall be recorded as the name of the manufacturer.

■ 15. In § 478.125a amend paragraph (a)(4) by:

- a. In the first sentence removing the words "serial number" and add in their place "serial number (including any associated license number either as a prefix, or if remanufactured or imported, separated by a semicolon)";
- b. Adding a new third sentence; and
- c. Designating the table as table 1 and revising newly designated table 1.

The addition and revision read as follows:

**§ 478.125a Personal firearms collection.**

- (a) \* \* \*
- (4) \* \* \* Where no manufacturer name has been identified on a privately made firearm, the words "privately made firearm" (or abbreviation "PMF") shall be recorded as the name of the manufacturer. \* \* \*

TABLE 1 TO PARAGRAPH (a)(4)—DISPOSITION RECORD OF PERSONAL FIREARMS

Description of firearm					Disposition		
Manufacturer, importer (if any), or "privately made firearm" (PMF)	Model	Serial No.	Type	Caliber or gauge	Date	Name and address (business address if licensee)	Date of birth if nonlicensee

■ 16. Amend § 478.129 by revising paragraphs (b), (d) and (e) to read as follows:

**§ 478.129 Record retention.**

\* \* \* \* \*

(b) *Firearms Transaction Record.* Licensees shall retain each Form 4473 until business or licensed activity is discontinued, either on paper, or in an electronic alternate method approved by the Director, at the business premises readily accessible for inspection under this part. Paper forms over 20 years of age may be stored at a separate warehouse, which shall be considered part of the business premises for this purpose and subject to inspection under this part. Forms 4473 shall be retained in the licensee's records as provided in § 478.124(b), provided that Forms 4473 with respect to which a sale, delivery,

or transfer did not take place shall be separately retained in alphabetical (by name of transferee) or chronological (by date of transferee's certification) order.

\* \* \* \* \*

(d) *Records of importation and manufacture.* Licensees shall maintain records of the importation, manufacture, or other acquisition of firearms, including ATF Forms 6 and 6A as required by subpart G of this part, until business or licensed activity is discontinued. Licensed importers' records and licensed manufacturers' records of the sale or other disposition of firearms after December 15, 1968, shall be retained until business is discontinued, either on paper or in an electronic alternate method approved by the Director, at the business premises readily accessible for inspection under this part. Paper records that do not

contain any open disposition entries and with no dispositions recorded within 20 years may be stored at a separate warehouse, which shall be considered part of the business premises for this purpose and subject to inspection under this part.

(e) *Records of dealers and collectors.* The records prepared by licensed dealers and licensed collectors of the sale or other disposition of firearms and the corresponding record of receipt of such firearms shall be retained until business or licensed activity is discontinued, either on paper, or in an electronic alternate method approved by the Director, at the business or collection premises readily accessible for inspection under this part. Paper records that do not contain any open disposition entries and with no dispositions recorded within 20 years



may be stored at a separate warehouse, which shall be considered part of the business or collection premises for this purpose and subject to inspection under this part.

\* \* \* \* \*

**PART 479—MACHINE GUNS, DESTRUCTIVE DEVICES, AND CERTAIN OTHER FIREARMS**

■ 17. The authority citation for part 479 continues to read as follows:

**Authority:** 26 U.S.C. 5812; 26 U.S.C. 5822; 26 U.S.C. 7801; 26 U.S.C. 7805.

**§ 479.11 [Revised]**

■ 18. Amend § 479.11 as follows:

- a. Add, in alphabetical order, definitions for “Complete muffler or silencer device” and “Complete weapon”;
- b. Revise the definition of “Frame or receiver”;
- c. Add the definition of “Readily”;
- d. Add a sentence at the end of the definition of “Transfer”.

The additions and revisions read as follows:

**§ 479.11 Meaning of terms.**

\* \* \* \* \*

*Complete muffler or silencer device.* A muffler or silencer that contains all component parts necessary to function, whether or not assembled or operable.

*Complete weapon.* A firearm other than a muffler or silencer that contains all component parts necessary to function, whether or not assembled or operable.

\* \* \* \* \*

*Frame or receiver.* The term “frame or receiver” shall have the same meaning as in § 478.12 of this subchapter.

\* \* \* \* \*

*Readily.* A process, action, or physical state that is fairly or reasonably efficient, quick, and easy, but not necessarily the most efficient, speediest, or easiest process, action, or physical state. With respect to the classification of firearms, factors relevant in making this determination include the following:

- (1) Time, *i.e.*, how long it takes to finish the process;
- (2) Ease, *i.e.*, how difficult it is to do so;
- (3) Expertise, *i.e.*, what knowledge and skills are required;
- (4) Equipment, *i.e.*, what tools are required;
- (5) Parts availability, *i.e.*, whether additional parts are required, and how easily they can be obtained;
- (6) Expense, *i.e.*, how much it costs;

(7) Scope, *i.e.*, the extent to which the subject of the process must be changed to finish it; and

(8) Feasibility, *i.e.*, whether the process would damage or destroy the subject of the process, or cause it to malfunction.

\* \* \* \* \*

*Transfer.* \* \* \* For purposes of this part, the term shall not include the temporary conveyance of a lawfully possessed firearm to a manufacturer or dealer qualified under this part for the sole purpose of repair, identification, evaluation, research, testing, or calibration and return to the same lawful possessor.

\* \* \* \* \*

■ 19. Revise § 479.102 to read as follows:

**§ 479.102 Identification of firearms.**

(a) *Identification required.* Except as otherwise provided in this section, you, as a manufacturer, importer, or maker of a firearm, must legibly identify the firearm as follows:

(1) *Serial number, name, place of business.* By engraving, casting, stamping (impressing), or otherwise conspicuously placing or causing to be engraved, cast, stamped (impressed) or otherwise placed on the frame or receiver thereof, an individual serial number, in a manner not susceptible of being readily obliterated, altered, or removed. The serial number must not duplicate any serial number placed by you on any other firearm. The frame or receiver must also be marked with either: Your name (or recognized abbreviation), and city and State (or recognized abbreviation) where you as a manufacturer or importer maintain your place of business, or in the case of a maker, where you made the firearm; or if a manufacturer or importer, your name (or recognized abbreviation) and the serial number that begins with your abbreviated Federal firearms license number, which is the first three and last five digits, as a prefix to a unique identification number, followed by a hyphen, *e.g.*, “12345678-[unique identification number]”; and

(2) *Model, caliber or gauge, foreign manufacturer, country of manufacture.* By engraving, casting, stamping (impressing), or otherwise conspicuously placing or causing to be engraved, cast, stamped (impressed) or placed on the frame or receiver, or barrel or pistol slide (if applicable) thereof certain additional information. This information must be placed in a manner not susceptible of being readily obliterated, altered, or removed. The additional information shall include:

(i) The model, if such designation has been made;

(ii) The caliber or gauge;

(iii) When applicable, the name of the foreign manufacturer or maker; and

(iv) In the case of an imported firearm, the name of the country in which it was manufactured. For additional requirements relating to imported firearms, see Customs regulations at 19 CFR part 134.

(3) *Multi-piece frame or receiver.* In the case of a multi-piece frame or receiver, the modular subpart that is the outermost housing or structure designed to house, hold, or contain either the primary energized component of a handgun, breech blocking or sealing component of a projectile weapon other than a handgun, or internal sound reduction component of a firearm muffler or firearm silencer, as the case may be, shall be the subpart of a multi-piece frame or receiver identified in accordance with this section. If more than one subpart is similarly designed to house, hold, or contain such primary component (*e.g.*, left and right halves), each of those subparts must be identified with the same serial number and associated licensee information not duplicated on any other frame or receiver. The identified subpart(s) of a complete (assembled or unassembled) multi-piece frame or receiver shall not be removed and replaced (*see* § 478.34 of this subchapter, 18 U.S.C. 922(k), and 26 U.S.C. 5861(g) and (h)), unless—

(A) The subpart replacement is not a firearm under 26 U.S.C. 5845;

(B) The subpart replacement is identified by the qualified manufacturer of the original subpart with the same serial number and associated licensee information in the manner prescribed by this section; and

(C) The original subpart is destroyed under the manufacturer’s control or direct supervision prior to such placement.

(4) *Frame or receiver, machine gun conversion part, or silencer part disposed of separately.* Each part defined as a frame or receiver or modular subpart thereof described in paragraph (a)(3) of this section, machinegun, or firearm muffler or firearm silencer that is not a component part of a complete weapon or complete muffler or silencer device at the time it is sold, shipped, or otherwise disposed of by you must be identified as required by this section with an individual serial number not duplicated on any other firearm and all additional identifying information, except that the model designation and caliber or gauge may be omitted if that information is unknown at the time the part is identified.

(5) *Size and depth of markings.* The engraving, casting, or stamping (impressing) of the serial number and additional information must be to a minimum depth of .003 inch, and the serial number and any associated license number in a print size no smaller than  $\frac{1}{16}$  inch. The size of the serial and license number is measured as the distance between the latitudinal ends of the character impression bottoms (bases). The depth of all markings required by this section is measured from the flat surface of the metal and not the peaks or ridges.

(6) *Period of time to identify firearms.* You shall identify a complete weapon or complete muffler or silencer device no later than close of the next business day following the date the entire manufacturing process has ended for the weapon or device, or prior to disposition, whichever is sooner. You must identify each part or modular subpart defined as a machine gun (frame or receiver, or conversion part) or muffler or silencer that is not a component part of a complete weapon or complete muffler or silencer device at the time it is sold, shipped, or otherwise disposed of no later than close of the next business day following the date the entire manufacturing process has ended for the part, or prior to disposition, whichever is sooner. For purposes of this paragraph, firearms awaiting materials, parts, or equipment repair to be completed are presumed, absent reliable evidence to the contrary, to be in the manufacturing process. Importers must identify imported firearms within the period prescribed in § 478.112 of this subchapter.

(7) *Meaning of marking terms.* For purposes of this section, the term “identify” means placing marks of identification, the terms “legible” and “legibly” mean that the identification markings (including any unique identification number) use exclusively Roman letters (e.g., A, a, B, b, C, c) and Arabic numerals (e.g., 1, 2, 3), or solely Arabic numerals, and may include a hyphen, and the terms “conspicuous” and “conspicuously” mean that the identification markings are capable of being easily seen with the naked eye during normal handling of the firearm and are unobstructed by other markings when the complete weapon or device is assembled.

(b) *Exceptions—(1) Alternate means of identification.* The Director may authorize other means of identification to identify firearms upon receipt of a letter application or prescribed form from you showing that such other identification is reasonable and will not

hinder the effective administration of this part.

(2) *Destructive devices.* In the case of a destructive device, the Director may authorize other means of identification to identify that weapon upon receipt of a letter application or prescribed form from you. The application shall show that engraving, casting, or stamping (impressing) such a weapon as required by this section would be dangerous or impracticable and that the alternate means of identification proposed will not hinder the effective administration of this part.

(3) *Adoption of identifying markings.* You may adopt existing markings and are not required to mark a serial number or other identifying markings previously placed on a firearm in accordance with this section, as follows:

(A) *Newly manufactured firearms.* Manufacturers may adopt the serial number and other identifying markings previously placed on a firearm by another manufacturer provided the firearm has not been sold, shipped, or otherwise disposed of to a person other than a qualified manufacturer, importer, or dealer, and the serial number adopted is not duplicated on any other firearm.

(B) *Remanufactured or imported firearms.* Manufacturers and importers may adopt the serial number or other identifying markings previously placed on a firearm that otherwise meets the requirements of this section that has been sold, shipped, or otherwise disposed of to a person other than a licensee provided that, within the period and in the manner herein prescribed, the manufacturer or importer legibly and conspicuously places, or causes to be placed, on the frame or receiver either: Their name (or recognized abbreviation), and city and State (or recognized abbreviation) where they maintain their place of business; or their name (or recognized abbreviation) and abbreviated Federal firearms license number, which is the first three and last five digits, individually (i.e., not as a prefix to the serial number adopted) after the letters “FFL”, in the following format: “FFL12345678”. The serial number adopted must not duplicate any serial number adopted or placed on any other firearm, except that if an importer receives two or more firearms with the same foreign manufacturer’s serial number, the importer may adopt the serial number by adding letters or numbers to that serial number, and may include a hyphen.

(C) *Manufacturers performing gunsmithing services.* Manufacturers may adopt the serial number or other identifying markings previously placed on a firearm by a qualified

manufacturer, importer, or dealer, provided the manufacturer is performing services as a gunsmith (as defined in § 478.11 of this subchapter) on existing firearms not for sale or distribution.

(4)(i) *Firearm muffler or silencer parts transferred between qualified manufacturers for further manufacture or to complete new devices.* Manufacturers qualified under this part may transfer a part defined as a muffler or silencer to another qualified manufacturer without immediately identifying or registering such part provided that it is for further manufacture (i.e., machining, coating, etc.) or manufacturing a complete muffler or silencer device. Once the new device with such part is completed, the manufacturer who completes the device shall identify and register it in the manner and within the period specified in this part for a complete muffler or silencer device.

(ii) *Firearm muffler or silencer replacement parts transferred to qualified manufacturers or dealers to repair existing devices.* Manufacturers qualified under this part may transfer a replacement part defined as a muffler or silencer other than a frame or receiver to a qualified manufacturer or dealer without identifying or registering such part provided that it is for repairing a complete muffler or silencer device that was previously identified and registered in accordance with this part and part 478.

(5) *Frames or receivers designed before August 24, 2022.* Manufacturers and importers may continue to identify the same component of a firearm defined as a frame or receiver as it existed before August 24, 2022 with the same information required to be marked by paragraphs (a)(1) and (a)(2) of this section that were in effect prior to that date, and any rules necessary to ensure such identification shall remain effective for that purpose. Any frame or receiver with a new design manufactured after August 24, 2022 must be marked with the identifying information and within the period prescribed by this section. For purposes of this paragraph, the term “new design” means that the design of the existing frame or receiver has been functionally modified or altered, as distinguished from performing a cosmetic process that adds to or changes the decoration of the frame or receiver (e.g., painting or engraving), or by adding or replacing stocks, barrels, or accessories to the frame or receiver.

(c) *Voluntary classification of firearms.* The Director may issue a determination (classification) to a

person whether an item, including a kit, is a firearm as defined in this part upon receipt of a written request or form prescribed by the Director. Each such voluntary request or form submitted shall be executed under the penalties of perjury with a complete and accurate description of the item or kit, the name and address of the manufacturer or importer thereof, and a sample of such item or kit for examination. A firearm sample must include all accessories and attachments relevant to such classification as each classification is limited to the firearm in the configuration submitted. Each request for classification of a partially complete, disassembled, or nonfunctional item or

kit must contain any associated templates, jigs, molds, equipment, or tools that are made available by the seller or distributor of the item or kit to the purchaser or recipient of the item or kit, and any instructions, guides, or marketing materials if they will be made available by the seller or distributor with the item or kit. Upon completion of the examination, the Director may return the sample to the person who made the request unless a determination is made that return of the sample would be or place the person in violation of law. Except for the classification of a specific component as the frame or receiver of a particular weapon, a determination made by the Director

under this paragraph shall not be deemed by any person to be applicable to or authoritative with respect to any other sample, design, model, or configuration.

**§ 479.103 [Amended]**

■ 20. In § 479.103, at the beginning of the third sentence, remove the word “All” and add in its place “Except as provided in § 479.102(b)(4), all”.

**Merrick B. Garland,**

*Attorney General.*

[FR Doc. 2022-08026 Filed 4-25-22; 8:45 am]

**BILLING CODE 4410-FY-P**